



CITY OF West Linn

22500 Salamo Road
West Linn, OR 97068

STAFF REPORT FOR THE PLANNING COMMISSION

FILE NUMBER: SUB-19-03

HEARING DATE: December 4, 2019

REQUEST: 15-lot Subdivision at 23000/23010 Bland Circle

APPROVAL CRITERIA: Community Development Code (CDC) Chapter 12, Single-Family Residential Detached and Attached, R-7; Chapter 48, Access, Egress and Circulation; Chapter 85 Land Division General Provisions; Chapter 92, Required Improvements.

STAFF REPORT PREPARED BY: Jennifer Arnold, Associate Planner

Community Development Director Initials ye

Development Review Engineer's Initials AP

TABLE OF CONTENTS

STAFF ANALYSIS AND RECOMMENDATION

GENERAL INFORMATION	2
EXECUTIVE SUMMARY	3
SITE CONDITIONS.....	3
RECOMMENDATION.....	3
ADDENDUM.....	5

EXHIBITS

PC-1 AFFIDAVIT AND NOTICE PACKET	19
PC-2 COMPLETENESS LETTER	23
PC-3 APPLICANT'S SUBMITTAL	25
PC-4 PUBLIC TESTIMONY	153

GENERAL INFORMATION

APPLICANT: Bland Circle, LLC/ATTN: Ben Looney
511 Main Street; Suite 101
Oregon City, OR 97045

CONSULTANT: Emerio Design, LLC
6445 SW Fallbrook PL. STE 100
Beaverton, OR 97008

OWNERS: John & Lynn Nilsen Robert & Cameron Bauer
23010 Bland Circle 23000 Bland Circle
West Linn, OR 97068 West Linn, OR 97068

SITE LOCATION: 23010/23000 Bland Circle West Linn, OR 97068

LEGAL DESCRIPTION: Tax lots 400, 404 & 201 Assessor’s Map 21E 35B

SITE SIZE: 152,427 square feet (3.49 acres)

ZONING: R-7, Single-Family Residential Detached and Attached. (7,000 square foot minimum lot size for single family detached homes)

COMP PLAN DESIGNATION: Low-Density Residential

120-DAY PERIOD: This application became complete on October 31, 2019. The 120-day maximum application-processing period ends on February 17, 2020.

PUBLIC NOTICE: Public notice was mailed to the all neighborhood associations and affected property owners on November 14, 2019. The property was posted with a notice sign on November 21, 2019. The notice was published in the West Linn Tidings on November 21, 2019. The notice requirements of CDC Chapter 99 have been met. In addition, the application was posted on the City’s website.

EXECUTIVE SUMMARY

The applicant seeks approval of an application for Subdivision Preliminary Plat for the development of 15 residential lots on the 3.49 ac site. All lots will exceed 7,000 square feet in size per the underlying R-7 zone.

The applicable approval criteria include:

- Chapter 12, Single-Family Residential Detached and Attached, R-7;
- Chapter 48, Access, Egress and Circulation;
- Chapter 85, Land Division General Provisions;
- Chapter 92, Required Improvements.

Public comments:

See Planning Commission Exhibit PC-4 for Public Testimony from TVF&R.

RECOMMENDATION

Staff recommends approval of application SUB-19-03, based on: 1) the findings submitted by the applicant, which are incorporated by this reference, 2) supplementary staff findings included in the Addendum below, and 3) the addition of conditions of approval below. With these findings, the applicable approval criteria are met. The conditions are as follows:

1. **Site Plan.** With the exception of modifications required by these conditions, the final plat shall conform to the submitted 'Preliminary Plat', (Sheet 6/13).
2. **Engineering Standards.** All public improvements and facilities including street improvements, utilities, grading, onsite storm water design, driveway placement and construction, pavement mitigation, street lighting, street trees, easements, and easement locations are subject to the City Engineer's review, modification, and approval per the City adopted Public Works standards. All improvements must be designed, constructed, and completed prior to final plat approval. The Director of Public Works may allow a waiver of improvements as allowed by Code. (See Staff Findings: 6, 12, 13, 19, 20, 21, 22, 29, 30, 31, 32, 33, 34, 35, 36, & 40)
3. **Sidewalk Construction.** The applicant shall dedicate 7 feet of frontage to the Bland Circle right-of-way and install a curb-tight sidewalk along Bland Circle from Fircrest Drive to the end of the northern edge of Parcel 1. Additionally, the applicant is required to upgrade the existing ADA ramp at the corner of Bland Circle and Fircrest Drive to meet current ADA Standards. All sidewalks adjacent to Eleanor

Street shall be separated from the curb with a landscaping strip. (See Staff Findings: 18, 20 & 28)

4. **Undergrounding Utilities.** The applicant shall underground all overhead utilities. (See Staff Findings: 36)
5. **Pedestrian Trails.** The applicant shall construct a trail and record a trail easement on the face of the plat connecting the existing trail located in an easement between 2137 and 2125 Satter Street through the property to Eleanor Street. (See Staff Findings: 28)
6. **Decommissioning Septic Systems and Wells.** The applicant shall properly abandon/decommission/remove existing wells and septic systems and shall supply the City with the approved documentation from their respective regulatory authorities. (See Staff Findings: 30 & 31)

ADDENDUM
PLANNING COMMISSION STAFF REPORT
December 4, 2019

**STAFF EVALUATION OF THE PROPOSAL'S COMPLIANCE
WITH APPLICABLE CODE CRITERIA**

**I. CHAPTER 12, SINGLE-FAMILY RESIDENTIAL DETACHED AND ATTACHED, R-7
12.030 PERMITTED USES**

The following uses are permitted outright in this zone.

1. *Single-family detached residential unit.*

(...)

6. *Utilities, minor*

(...)

12.070 DIMENSIONAL REQUIREMENTS, USES PERMITTED OUTRIGHT AND USES PERMITTED UNDER PRESCRIBED CONDITIONS

Except as may be otherwise provided by the provisions of this code, the following are the requirements for uses within this zone:

A. *The minimum lot size shall be:*

1. *For a single-family detached unit, 7,000 square feet.*

2. *For each attached single-family unit, 5,500 square feet. No yard shall be required between the units.*

B. *The minimum front lot line length or the minimum lot width at the front lot line shall be 35 feet.*

C. *The average minimum lot width shall be 35 feet.*

D. *Repealed by Ord. 1622.*

E. *The minimum yard dimensions or minimum building setback areas from the lot line shall be:*

1. *For the front yard, 20 feet, except for steeply sloped lots where the provisions of CDC 41.010 shall apply.*

2. *For an interior side yard, seven and one-half feet.*

3. *For a side yard abutting a street, 15 feet.*

4. *For a rear yard, 20 feet.*

F. *The maximum building height shall be 35 feet, except for steeply sloped lots in which case the provisions of CDC 41.010 shall apply.*

G. *The maximum lot coverage shall be 35 percent.*

H. *The minimum width of an accessway to a lot which does not abut a street or a flag lot shall be 15 feet.*

I. *The maximum floor area ratio shall be 0.45. Type I and II lands shall not be counted toward lot area when determining allowable floor area ratio, except that a minimum floor area ratio of*

0.30 shall be allowed regardless of the classification of lands within the property. That 30 percent shall be based upon the entire property including Type I and II lands. Existing residences in excess of this standard may be replaced to their prior dimensions when damaged without the requirement that the homeowner obtain a non-conforming structures permit under Chapter 66 CDC.

J. The sidewall provisions of Chapter 43 CDC shall apply. (Ord. 1226, 1988; Ord. 1308, 1991; Ord. 1377, 1995; Ord. 1538, 2006; Ord. 1622 § 24, 2014; Ord. 1675 § 11, 2018)

Staff Response 1: The only uses proposed by the applicant are single-family detached residential units and a stormwater facility. The stormwater facility is not a substation, pump station, water storage tank, for the purposes of sewer, or a treatment plant, and therefore identified as a minor utility (a permitted use). All other standards above are also met or exceeded by each lot. At the time that building permits are applied for the construction of a house, the front, side and rear setbacks, building height, lot coverage, FAR, sidewall transition requirements, off-street parking, fencing, and clear vision provisions on corner lots will be reviewed for compliance. The existing house, at 23010 Bland Circle, is shown to meet the required R-7 setbacks. Staff determines the criterion is met.

CHAPTER 48, ACCESS CONTROL

48.025 ACCESS CONTROL

B. Access Control Standards

1. Traffic impact analysis requirements. The City or other agency with access jurisdiction may require a traffic study prepared by a qualified professional to determine access, circulation and other transportation requirements. (See also CDC [55.125](#), Traffic Impact Analysis.)

Staff Finding 2: No traffic impact analysis (TIA) is required since none of the criteria of 85.170(B) (2) are met. For example, an Average Daily Trip count (ADT) of 250 is required before a TIA is needed. The addition of 15 additional/new homes should only generate an ADT of 143.55 new trips per day according to the Institute of Traffic Engineers (ITE) trip generation tables at 9.57 trips per household. This criterion is met.

2. The City or other agency with access permit jurisdiction may require the closing or consolidation of existing curb cuts or other vehicle access points, recording of reciprocal access easements (i.e., for shared driveways), development of a frontage street, installation of traffic control devices, and/or other mitigation as a condition of granting an access permit, to ensure the safe and efficient operation of the street and highway system. Access to and from off-street parking areas shall not permit backing onto a public street.

Staff Finding 3: Access to this site will be via the existing public street Bland Circle or the new public street Eleanor Street. All proposed driveways will be reviewed by the City Engineer at the time of building permit review. This criterion is met.

3. *Access options. When vehicle access is required for development (i.e., for off-street parking, delivery, service, drive-through facilities, etc.), access shall be provided by one of the following methods (planned access shall be consistent with adopted public works standards and TSP). These methods are “options” to the developer/subdivider.*

a) *Option 1. Access is from an existing or proposed alley or mid-block lane. If a property has access to an alley or lane, direct access to a public street is not permitted.*

b) *Option 2. Access is from a private street or driveway connected to an adjoining property that has direct access to a public street (i.e., “shared driveway”). A public access easement covering the driveway shall be recorded in this case to assure access to the closest public street for all users of the private street/drive.*

c) *Option 3. Access is from a public street adjacent to the development lot or parcel. If practicable, the owner/developer may be required to close or consolidate an existing access point as a condition of approving a new access. Street accesses shall comply with the access spacing standards in subsection (B) (6) of this section.*

Staff Finding 4: The applicant proposes access to all lots by use of Option 3. All access points will be made directly onto a public street (Bland Circle or proposed Eleanor Street). The applicant is proposing several shared driveways to limit curb cuts and to meet spacing standards. These criteria are met.

4. *Subdivisions fronting onto an arterial street.*

(...)

5. *Double-frontage lots.*

(...)

Staff Finding 5: This subdivision does not front on an arterial, as Bland Circle is a local street along the sites frontage. To the south of the property Bland Circle is classified as neighborhood route from the Bland Circle/Crestview Drive intersection over to Salamo Road. Access of these lots will be via Bland Circle and the new proposed street Eleanor Street. See Staff Findings 12 and 13. Proposed lots 4 and 14 are both corner lots and are the only two double frontage lots proposed with this application. These criteria are satisfied.

6. *Access spacing.*

(...)

7. *Number of access points.*

8. *Shared driveways.*

Staff Finding 6: Proposed lots 5-8, 10, 11, 3 and 4 have a shared driveway shown on sheet 9/13. All other proposed lots will access a public street via newly constructed individual driveways per condition of approval 2. Subject to the conditions of approval, the criteria is met.

C. Street connectivity and formation of blocks required.

In order to promote efficient vehicular and pedestrian circulation throughout the City, land divisions and large site developments shall produce complete blocks bounded by a connecting network of public and/or private streets, in accordance with the following standards:

1. Block length and perimeter.

The maximum block length shall not exceed 800 feet or 1,800 feet along an arterial.

Staff Finding 7: The applicant is proposing a new public street, Eleanor Street, coming off Bland Circle and stubbing to the northern property line. The applicant is not proposing any blocks exceeding 800 feet with this application. This criterion is met.

48.030 MINIMUM VEHICULAR REQUIREMENTS FOR RESIDENTIAL USES

A. Direct individual access from single-family dwellings and duplex lots to an arterial street (...)

B. When any portion of any house is less than 150 feet from the adjacent right-of-way, access to the home is as follows:

- 1. One single-family residence, including residences with an accessory dwelling unit as defined in CDC 02.030, shall provide 10 feet of unobstructed horizontal clearance. Dual-track or other driveway designs that minimize the total area of impervious driveway surface are encouraged.*
- 2. Two to four single-family residential homes equals a 14- to 20-foot-wide paved or all-weather surface. Width shall depend upon adequacy of line of sight and number of homes.*

Staff Finding 8: Bland Circle is classified as a local street along the subject property's frontage. Proposed lots 6, 7 and 12 all have potential homes placed more than 150 feet from public right of way. The proposed access width to lots 6 and 7 is 16 feet (total) and access width to proposed lot 12 is 15.9 feet. Lots 5-8, 10, 11, 3 and 4 have a shared driveway shown on sheet 9/13 and the homes will be less than 150 feet from public right-of-way. The access width for lots 10 and 11 will be approximately 21.4 feet. All other access will be via individual driveways and all access ways will be reviewed for compliance with engineering standards at the time a site development permit is applied for. These criteria are met.

3. Maximum driveway grade shall be 15 percent. The 15 percent shall be measured along the centerline of the driveway only. Variations require approval of a Class II variance by the Planning Commission pursuant to Chapter 75 CDC. Regardless, the last 18 feet in front of the garage shall be under 12 percent grade as measured along the centerline of the driveway only. Grades elsewhere along the driveway shall not apply.

Staff Finding 9: The applicant shall comply with maximum driveway grades and will be reviewed by the City Engineer during construction of the homes. This criterion is met.

4. The driveway shall include a minimum of 20 feet in length between the garage door and the back of sidewalk, or, if no sidewalk is proposed, to the paved portion of the right-of-way.

Staff Finding 10: The applicant shall comply with driveway length requirements and reviewed by the City Engineer during the construction of the homes. These criteria are met.

C. When any portion of one or more homes is more than 150 feet from the adjacent right-of-way, the provisions of subsection B of this section shall apply in addition to the following provisions.

- 1. A turnaround may be required as prescribed by the Fire Chief.*
- 2. Minimum vertical clearance for the driveway shall be 13 feet, six inches.*
- 3. A minimum centerline turning radius of 45 feet is required unless waived by the Fire Chief.*
- 4. There shall be sufficient horizontal clearance on either side of the driveway so that the total horizontal clearance is 20 feet*

Staff Finding 11: See staff finding 8. An approved TVFR turnaround is shown on the applicant's proposed plans (sheets 7/13 and 10/13). These criteria are met.

E. Access and/or service drives for multi-family dwellings shall be fully improved with hard surface pavement:

- 1. With a minimum of 24-foot width when accommodating two-way traffic; or*
- 2. With a minimum of 15-foot width when accommodating one-way traffic. Horizontal clearance shall be two and one-half feet wide on either side of the driveway.*
- 3. Minimum vertical clearance of 13 feet, six inches.*
- 4. Appropriate turnaround facilities per Fire Chief's standards for emergency vehicles when the drive is over 150 feet long. Fire Department turnaround areas shall not exceed seven percent grade unless waived by the Fire Chief.*
- 5. The grade shall not exceed 10 percent on average, with a maximum of 15 percent.*
- 6. A minimum centerline turning radius of 45 feet for the curve.*

F. Where on-site maneuvering and/or access drives are necessary to accommodate required parking, in no case shall said maneuvering and/or access drives be less than that required in Chapters 46 and 48 CDC.

G. The number of driveways or curb cuts shall be minimized on arterials or collectors. Consolidation or joint use of existing driveways shall be required when feasible.

H. In order to facilitate through traffic and improve neighborhood connections, it may be necessary to construct a public street through a multi-family site.

I. Gated accessways to residential development other than a single-family home are prohibited.

Staff Finding 12: The applicant proposal is for single-family homes with no gated access points. No arterial roadways are proposed with this application. All driveways shall meet the engineering standards of Condition of Approval number 2. These criteria are met.

48.060 WIDTH AND LOCATION OF CURB CUTS AND ACCESS SEPARATION REQUIREMENTS

A. Minimum curb cut width shall be 16 feet.

B. *Maximum curb cut width shall be 36 feet, except along Highway 43 in which case the maximum curb cut shall be 40 feet. For emergency service providers, including fire stations, the maximum shall be 50 feet.*

C. *No curb cuts shall be allowed any closer to an intersecting street right-of-way line than the following:*

1. *On an arterial when intersected by another arterial, 150 feet.*

(...)

6. *On a local street when intersecting any other street, 35 feet.*

Staff Finding 13: All driveways and curb cuts shall meet the engineering standards of Condition of Approval number 2. These criteria are met.

D. *There shall be a minimum distance between any two adjacent curb cuts on the same side of a public street, except for one-way entrances and exits, as follows:*

1. *On an arterial street, 150 feet.*

2. *On a collector street, 75 feet.*

3. *Between any two curb cuts on the same lot or parcel on a local street, 30 feet.*

(...)

E. *A rolled curb may be installed in lieu of curb cuts and access separation requirements.*

Staff Finding 14: See Staff Finding 12-13. These criteria are met.

F. *Curb cuts shall be kept to the minimum, particularly on Highway 43. Consolidation of driveways is preferred. The standard on Highway 43 is one curb cut per business if consolidation of driveways is not possible.*

Staff Finding 15: The applicant proposes to provide access to the new proposed public street or via Bland Circle. Both public streets are classified as local streets and not located on or near highway 43. This criterion is met.

G. *Adequate line of sight pursuant to engineering standards should be afforded at each driveway or accessway.*

Staff Finding 16: The driveway spacing standards reviewed at the time of building permit plan review verify compliance with Chapter 48 requirements. This criterion is met.

55.100 APPROVAL STANDARDS – CLASS II DESIGN REVIEW

(Design Review is only applicable to significant trees as cross referenced by CDC 85.200(J)(9))

B. *Relationship to the natural and physical environment.*

1. *The buildings and other site elements shall be designed and located so that all heritage trees, as defined in the municipal code, shall be saved. Diseased heritage trees, as determined by the City Arborist, may be removed at his/her direction.*
2. *All heritage trees, as defined in the municipal code, all trees and clusters of trees ("cluster" is defined as three or more trees with overlapping driplines; however, native oaks need not have an overlapping dripline) that are considered significant by the City Arborist, either individually or in consultation with certified arborists or similarly qualified professionals, based on accepted arboricultural standards including consideration of their size, type, location, health, long term survivability, and/or numbers, shall be protected pursuant to the criteria of subsections (B)(2)(a) through (f) of this section. (...)*

Non-residential and residential projects on Type I and II lands shall protect all heritage trees and all significant trees and tree clusters by limiting development in the protected area. (...)

Staff Finding 17: There are no heritage trees on the subject property. There are 58 significant trees on the property as verified by the City Arborist. The applicant proposes to retain 13 significant trees (22%). The criteria is met.

CHAPTER 85, GENERAL PROVISIONS (LAND DIVISION)

85.200 APPROVAL CRITERIA

No tentative subdivision or partition plan shall be approved unless adequate public facilities will be available to provide service to the partition or subdivision area prior to final plat approval and the Planning Commission or Planning Director, as applicable, finds that the following standards have been satisfied, or can be satisfied by condition of approval.

A. Streets.

1. *General. The location, width and grade of streets shall be considered in their relation to existing and planned streets (...) Internal streets are the responsibility of the developer. All streets bordering the development site are to be developed by the developer with, typically, half-street improvements or to City standards prescribed by the Public Works Director. (...)*

Staff Finding 18: The applicant proposes a new local residential street, Eleanor Street, with a 52 foot wide right-of-way to include sidewalks on both sides and along the property's frontage along Bland Circle. Additionally, the applicant shall be required to extend a curb tight sidewalk along Bland Circle to the intersection of Bland Circle and Fircrest Drive per condition of approval 3. Subject to the approval of proposed conditions, this criteria is met.

2. *Right-of-way and roadway widths.*
3. *Street widths. Street widths shall depend upon which classification of street is proposed. The classifications and required cross sections are established in Chapter 8 of the adopted TSP. (...)*
4. *The decision-making body shall consider the Public Works Director's recommendations on the desired right-of-way width, pavement width and street geometry of the various street types within the subdivision after consideration by the Public Works Director of the following criteria:*

(...)

Staff Finding 19: See Staff Finding 17. The criteria is met.

(...)

16. *Sidewalks. Sidewalks shall be installed per CDC 92.010(H), Sidewalks. The residential sidewalk width is six feet plus planter strip...or to match existing sidewalks or right-of-way limitations.*

(...)

Staff Finding 20: The applicant proposes a new local residential street, Eleanor Street, with a 52 foot wide right-of-way to include sidewalks on both sides and along the property's frontage along Bland Circle. Additionally, the applicant shall be required to extend a curb tight sidewalk along Bland Circle to the intersection of Bland Circle and Fircrest Drive per condition of approval 3. Additionally, the applicant is required to upgrade the existing ADA ramp at the corner of Bland Circle and Fircrest Drive to meet current ADA Standards. Subject to conditions of approval the criteria is met.

(...)

19. *All lots in a subdivision shall have access to a public street. Lots created by partition may have access to a public street via an access easement pursuant to the standards and limitations set forth for such accessways in Chapter 48 CDC.*

Staff Finding 21: All lots will access a public street (Bland Circle or Eleanor Street) via individual or shared driveways. See condition of approval 2 and staff finding 3. Subject to conditions of approval, the criteria is met.

(...)

22. *Based upon the determination of the City Manager or the Manager's designee, the applicant shall construct or cause to be constructed, or contribute a proportionate share of the costs, for all necessary off-site improvements identified by the transportation analysis commissioned to address CDC 85.170(B)(2) that are required to mitigate impacts from the proposed subdivision.*

Staff Finding 22: The only off site improvement required is the extension of the curb-tight sidewalk on Bland Circle to the intersection of Bland Circle and Fircrest Drive and associated ADA ramp upgrade per condition of approval 3. The criteria is met.

B. Blocks and lots.

1. General

(...)

2. Sizes

(...)

3. *Lot size and shape*

Staff Finding 23: Staff incorporates applicant findings on page 24 of 30 of the applicant's submittal dated 10/18/19. These criteria are met.

4. Access. *Access to subdivisions, partitions, and lots shall conform to the provisions of Chapter 48 CDC, Access, Egress and Circulation.*

Staff Finding 24: Please see staff findings 3 to 16. The criterion is met.

5. *Double frontage lots and parcels.*

(...)

6. *Lot and parcel side lines*

Staff Finding 25: Proposed lots 2, 4, and 14 are corner lots and the only double frontage lots proposed with this application. These criteria is met.

7. *Flag lots. Flag lots can be created where it can be shown that no other reasonable street access is possible to achieve the requested land division. A single flag lot shall have a minimum street frontage of 15 feet for its accessway. Where two to four flag lots share a common accessway, the minimum street frontage and accessway shall be eight feet in width per lot. Common accessways shall have mutual maintenance agreements and reciprocal access and utility easements. The following dimensional requirements shall apply to flag lots:*

a. *Setbacks applicable to the underlying zone shall apply to the flag lot.*

(...)

e. *As per CDC 48.030, the accessway shall have a minimum paved width of 12 feet.*

Staff Finding 26: The applicant proposes a 2 true flag lots for lots 6 and 7. Access for lots 11, 12 and 15 are via a shared access easement (not the same access easement). The access for the two true flag lots is proposed to be 16 feet total (each lot has 8 feet of frontage). The shared access for lots 11, 12 and 15 is shown to be 15-20 feet. These criteria are satisfied.

8. *Large lots or parcels.*

Staff Finding 27: Staff incorporates applicant findings on page 26 of 39 of the applicant's submittal dated 10/18/19. This criterion is met.

C. *Pedestrian and bicycle trails.*

(...)

D. *Transit Facilities.*

(...)

Staff Finding 28: The TSP does not identify Bland Circle in the Bike Plan (See Figures 10 of the TSP), but does include a section of Bland Circle south of the subject property in the pedestrian improvement projects table (See TSP Table 4). The applicant is proposing and also conditioned to continue the Bland Circle sidewalk to the northern boundary of the subject property. Additionally, the applicant shall record a trail easement on proposed lot 7 to make the connection between the existing trail on Tract J and the trail easement between 2137 and 2125 Satter Street. Subject to approval of the proposed conditions, the criteria is met.

E. Grading.

Grading of building sites shall conform to the following standards unless physical conditions demonstrate the propriety of other standards:

- 1. All cuts and fills shall comply with the excavation and grading provisions of the Uniform Building Code and the following:*
 - a. Cut slopes shall not exceed one and one-half feet horizontally to one foot vertically (i.e., 67 percent grade).*
 - b. Fill slopes shall not exceed two feet horizontally to one foot vertically (i.e., 50 percent grade). Please see the following illustration.*
- 2. The character of soil for fill and the characteristics of lot and parcels made usable by fill shall be suitable for the purpose intended.*
- 3. If areas are to be graded (more than any four-foot cut or fill), compliance with CDC [85.170\(C\)](#) is required.*
- 4. The proposed grading shall be the minimum grading necessary to meet roadway standards, and to create appropriate building sites, considering maximum allowed driveway grades.*
- 5. Type I lands shall require a report submitted by an engineering geologist, and Type I and Type II lands shall require a geologic hazard report.*
- 6. Repealed by Ord. 1635.*
- 7. On land with slopes in excess of 12 percent, cuts and fills shall be regulated as follows:*
 - a. Toes of cuts and fills shall be set back from the boundaries of separate private ownerships at least three feet, plus one-fifth of the vertical height of the cut or fill. Where an exception is required from that requirement, slope easements shall be provided.*
 - b. Cuts shall not remove the toe of any slope where a severe landslide or erosion hazard exists (as described in subsection (G)(5) of this section).*
 - c. Any structural fill shall be designed by a registered engineer in a manner consistent with the intent of this code and standard engineering practices, and certified by that engineer that the fill was constructed as designed.*
 - d. Retaining walls shall be constructed pursuant to Section 2308(b) of the Oregon State Structural Specialty Code.*
 - e. Roads shall be the minimum width necessary to provide safe vehicle access, minimize cut and fill, and provide positive drainage control.*
- 8. Land over 50 percent slope shall be developed only where density transfer is not feasible. The development will provide that:*
 - a. At least 70 percent of the site will remain free of structures or impervious surfaces.*
 - b. Emergency access can be provided.*
 - c. Design and construction of the project will not cause erosion or land slippage.*

d. Grading, stripping of vegetation, and changes in terrain are the minimum necessary to construct the development in accordance with subsection J of this section.

Staff Finding 29: All grading and erosion control plans will be reviewed by the City Engineer at the time the applicant applies for building permits. A geotechnical report was submitted with this subdivision application (see applicant's submitted Geotechnical Report dated 12/7/2018 and updated 9/13/19). The criteria is met.

F. Water.

- 1. A plan for domestic water supply lines or related water service facilities shall be prepared consistent with the adopted Comprehensive Water System Plan, plan update, March 1987, and subsequent superseding revisions or updates.*
- 2. Adequate location and sizing of the water lines.*
- 3. Adequate looping system of water lines to enhance water quality.*
- 4. For all non-single-family developments, there shall be a demonstration of adequate fire flow to serve the site.*
- 5. A written statement, signed by the City Engineer, that water service can be made available to the site by the construction of on-site and off-site improvements and that such water service has sufficient volume and pressure to serve the proposed development's domestic, commercial, industrial, and fire flows.*

Staff Finding 30: The existing home on proposed lot 15 is shown to meet setback requirements with the new lot configuration. The applicant is responsible for decommissioning any wells and septic systems associated with the two existing homes. The home shown on proposed lot 15 shall connect to City utility services as a condition of this development. See 'Composite Utility Plan' sheet 8/13 of the applicant's submittal. Subject to approval of the proposed conditions, the criteria is met.

G. Sewer.

- 1. A plan prepared by a licensed engineer shall show how the proposal is consistent with the Sanitary Sewer Master Plan (July 1989). Agreement with that plan must demonstrate how the sanitary sewer proposal will be accomplished and how it is gravity-efficient. The sewer system must be in the correct basin and should allow for full gravity service.*
- 2. Sanitary sewer information will include plan view of the sanitary sewer lines, including manhole locations and depth or invert elevations.*
- 3. Sanitary sewer lines shall be located in the public right-of-way, particularly the street, unless the applicant can demonstrate why the alternative location is necessary and meets accepted engineering standards.*
- 4. Sanitary sewer line should be at a depth that can facilitate connection with down-system properties in an efficient manner.*
- 5. The sanitary sewer line should be designed to minimize the amount of lineal feet in the system.*
- 6. The sanitary sewer line shall avoid disturbance of wetland and drainageways. In those cases where that is unavoidable, disturbance shall be mitigated pursuant to Chapter 32 CDC, Water*

Resource Area Protection, all trees replaced, and proper permits obtained. Dual sewer lines may be required so the drainageway is not disturbed.

7. Sanitary sewer shall be extended or stubbed out to the next developable subdivision or a point in the street that allows for reasonable connection with adjacent or nearby properties.

8. The sanitary sewer system shall be built pursuant to DEQ, City, and Tri-City Service District sewer standards. The design of the sewer system should be prepared by a licensed engineer, and the applicant must be able to demonstrate the ability to satisfy these submittal requirements or standards at the pre-construction phase.

9. A written statement, signed by the City Engineer, that sanitary sewers with sufficient capacity to serve the proposed development and that adequate sewage treatment plant capacity is available to the City to serve the proposed development

Staff Finding 31: The Sewer Master Plan has confirmed that there is sufficient sanitary system and sewage treatment facility capacity. The existing home on proposed lot 15 is shown to meet setback requirements with the new lot configuration. The applicant is responsible for decommissioning any wells and septic systems associated with the two existing homes. The home shown on proposed lot 15 shall connect to City utility services as a condition of this development. See ‘Composite Utility Plan’ sheet 8/13 of the applicant’s submittal. Subject to approval of the proposed conditions, the criteria is met.

H. Storm detention and treatment. All proposed storm detention and treatment facilities comply with the standards for the improvement of public and private drainage systems located in the West Linn Public Works Design Standards, there will be no adverse off-site impacts caused by the development (including impacts from increased intensity of runoff downstream or constrictions causing ponding upstream), and there is sufficient factual data to support the conclusions of the submitted plan.

Staff Finding 32: The applicant has submitted a stormwater report dated 7/8/19 found in the applicant’s submittal. The stormwater facility is not a substation, pump station, water storage tank, for the purposes of sewer, or a treatment plant, and therefore identified as a minor utility (a permitted use in the R-7 zone). This criteria is met.

I. Utility easements.

Subdivisions and partitions shall establish utility easements to accommodate the required service providers as determined by the City Engineer. The developer of the subdivision shall make accommodation for cable television wire in all utility trenches and easements so that cable can fully serve the subdivision.

Staff Finding 33: An 8 foot public utility easement shall be recorded on the face of the plat per condition of approval 2. The applicant shows this easement on sheet 6/13 ‘Preliminary Plat’. This criteria is met.

J. Supplemental provisions.

(...)

3. *Street trees.*

Street trees are required as identified in the appropriate section of the municipal code and Chapter [54](#) CDC.

4. *Lighting.*

To reduce ambient light and glare, high or low pressure sodium light bulbs shall be required for all subdivision street or alley lights. The light shall be shielded so that the light is directed downwards rather than omni-directional.

Staff Finding 34: The applicant will provide street trees and street lighting on Bland Circle and Eleanor Street, as required by the Public Works standards and Condition of Approval 2. See the applicant's submitted Lighting plan on sheet 13/13. The criteria is met.

5. *Dedications and exactions.*

The City may require an applicant to dedicate land and/or construct a public improvement that provides a benefit to property or persons outside the property that is the subject of the application when the exaction is roughly proportional. No exaction shall be imposed unless supported by a determination that the exaction is roughly proportional to the impact of development.

Staff Finding 35: The subject property fronts Bland Circle. The applicant shall dedicate 7 feet of the frontage to the Bland Circle right-of-way and construct a curb-tight sidewalk per condition of approval 3. This dedication is shown on sheet 7/13 'Preliminary Plat'. The applicant also proposes to dedicate the new proposed public street, Eleanor Street. Subject to the approval of the proposed conditions, this criterion is met.

6. *Underground utilities.*

All utilities, such as electrical, telephone, and television cable, that may at times be above ground or overhead shall be buried underground in the case of new development. The exception would be in those cases where the area is substantially built out and adjacent properties have above-ground utilities and where the development site's frontage is under 200 feet and the site is less than one acre. High voltage transmission lines, as classified by Portland General Electric or electric service provider, would also be exempted. Where adjacent future development is expected or imminent, conduits may be required at the direction of the City Engineer. All services shall be underground with the exception of standard above-grade equipment such as some meters, etc.

Staff Finding 36: The subject property does meet the exemptions for undergrounding overhead utilities. The applicant shall underground all utilities per condition of approval 4. Subject to the approval of the recommended conditions, this criterion is met.

7. *Density requirement.*

Density shall occur at 70 percent or more of the maximum density allowed by the underlying zoning. These provisions would not apply when density is transferred from Type I and II lands as defined in CDC 02.030. Development of Type I or II lands are exempt from these provisions. Land divisions of three lots or less would also be exempt.

Staff Finding 37: See applicant submitted sheet titled ‘Slope Analysis Plan’ 6/13. The subject property is 3.49 acres and contains 21,585 square feet of Type I or II lands. The subject property contains 199,130 square feet of land sloped less than 25%. 15 lots are proposed by the applicant and no lots are proposed considered oversized. This criterion is met.

8. *Mix requirement.*

The “mix” rule means that developers shall have no more than 15 percent of the R-2.1 and R-3 development as single-family residential. The intent is that the majority of the site shall be developed as medium high density multi-family housing.

Staff Finding 38: The property is zoned R-7, so this criteria does not apply.

9. *Heritage trees/significant tree and tree cluster protection.*

All heritage trees, as defined in the Municipal Code, shall be saved. Diseased heritage trees, as determined by the City Arborist, may be removed at his/her direction. All non-heritage trees and clusters of trees (three or more trees with overlapping dripline; however, native oaks need not have an overlapping dripline) that are considered significant by virtue of their size, type, location, health, or numbers shall be saved pursuant to CDC 55.100(B)(2). Trees are defined per the municipal code as having a trunk six inches in diameter or 19 inches in circumference at a point five feet above the mean ground level at the base of the trunk.

Staff Finding 39: See Staff Finding 17. This criterion is met.

CHAPTER 92, REQUIRED IMPROVEMENTS

92.010 PUBLIC IMPROVEMENTS FOR ALL DEVELOPMENT

The following improvements shall be installed at the expense of the developer and meet all City codes and standards:

- A. *Streets within subdivisions.*
 - B. *Extension of streets to subdivisions*
 - C. *Local and minor collector streets*
 - D. *Monuments*
- (...)

92.030 IMPROVEMENT PROCEDURES

(...)

Staff Finding 40: The applicant shall comply with the requirements and install improvements to meet the West Linn Public Works Standards. Subject to condition of approval 2, these criteria are met.

PC-1

AFFIDAVIT OF NOTICE PACKET

AFFIDAVIT OF NOTICE

We, the undersigned do hereby certify that, in the interest of the party (parties) initiating a proposed land use, the following took place on the dates indicated below:

GENERAL

File No. SDB-19-03 Applicant's Name Bland Circle, LLC
Development Name _____
Scheduled Meeting/Decision Date December 4, 2019

NOTICE: Notices were sent at least 20 days prior to the scheduled hearing, meeting, or decision date per Section 99.080 of the Community Development Code. (check below)

TYPE A X

- A. The applicant (date) 11/14/19 (signed) Jenit Auld
- B. Affected property owners (date) 11/14/19 (signed) Jenit Auld
- C. School District/Board (date) _____ (signed) _____
- D. Other affected gov't. agencies (date) 11/14/19 (signed) Jenit Auld
- E. Affected neighborhood assns. (date) 11/14/19 (signed) Jenit Auld
- F. All parties to an appeal or review (date) _____ (signed) _____

At least 10 days prior to the scheduled hearing or meeting, notice was published/posted:

Tidings (published date) 11/21/19 (signed) Jenit Auld
City's website (posted date) 11/14/19 (signed) Jenit Auld

SIGN

At least 10 days prior to the scheduled hearing, meeting or decision date, a sign was posted on the property per Section 99.080 of the Community Development Code.

(date) 11/21/19 (signed) Jenit Auld

NOTICE: Notices were sent at least 14 days prior to the scheduled hearing, meeting, or decision date per Section 99.080 of the Community Development Code. (check below)

~~**TYPE B**~~

- ~~A. The applicant (date) _____ (signed) _____~~
- ~~B. Affected property owners (date) _____ (signed) _____~~
- ~~C. School District/Board (date) _____ (signed) _____~~
- ~~D. Other affected gov't. agencies (date) _____ (signed) _____~~
- ~~E. Affected neighborhood assns. (date) _____ (signed) _____~~

~~Notice was posted on the City's website at least 10 days prior to the scheduled hearing or meeting.~~

~~Date: _____ (signed) _____~~

STAFF REPORT mailed to applicant, City Council/Planning Commission and any other applicable parties 10 days prior to the scheduled hearing.

(date) 11/21/19 (signed) Jenit Auld

FINAL DECISION notice mailed to applicant, all other parties with standing, and, if zone change, the County surveyor's office.

(date) _____ (signed) _____

**CITY OF WEST LINN PLANNING COMMISSION
PUBLIC HEARING NOTICE
FILE NO. SUB-19-03**

The West Linn Planning Commission will hold a public hearing, on **Wednesday, December 4, 2019, starting at 6:30 p.m.** in the Council Chambers of City Hall, 22500 Salamo Road, West Linn, to consider a request for a 15-lot subdivision at 23000/23010 Bland Circle.

The decision by the Planning Commission to approve or deny this request will be based upon the applicable criteria found in Chapters 12, 48, 85, 92, and 99 of the West Linn Community Development Code. At the hearing, it is important that comments relate specifically to the applicable criteria.

You have been notified of this proposal because County records indicate that you own property within 500 feet of the subject property (Clackamas County Assessor's Map 2S-1E-35B, Tax Lots 400, 404, & 201), or as otherwise required by Chapter 99 of the CDC.

The complete application in the above noted file is available for inspection at no cost at City Hall or via the web site at <https://westlinnoregon.gov/planning/2300023010-bland-circle-15-lot-subdivision> or copies can be obtained for a minimal charge per page. At least ten days prior to the hearing, a copy of the staff report will be available for inspection. For further information, please contact Associate Planner Jennifer Arnold at jarnold@westlinnoregon.gov or 503-742-6057. Alternately, visit City Hall, 22500 Salamo Road, West Linn, OR 97068.

The hearing will be conducted in accordance with the rules of Section 99.170 of the CDC. Anyone wishing to present written testimony on this proposed action may do so in writing prior to, or at the public hearing. Oral testimony may be presented at the public hearing. At the public hearing, the Planning Commission will receive a staff presentation, and invite both oral and written testimony. The Planning Commission may continue the public hearing to another meeting to obtain additional information, leave the record open for additional evidence, arguments, or testimony, or close the public hearing and take action on the application as provided by state law. **In the event that the Planning Commission decision is appealed, City Council review of the appeal will be de novo.** Failure to raise an issue in person or by letter at some point prior to the close of the hearing, or failure to provide sufficient specificity to afford the decision maker an opportunity to respond to the issue, precludes an appeal to the Land Use Board of Appeals (LUBA) based on that issue.

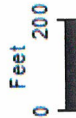
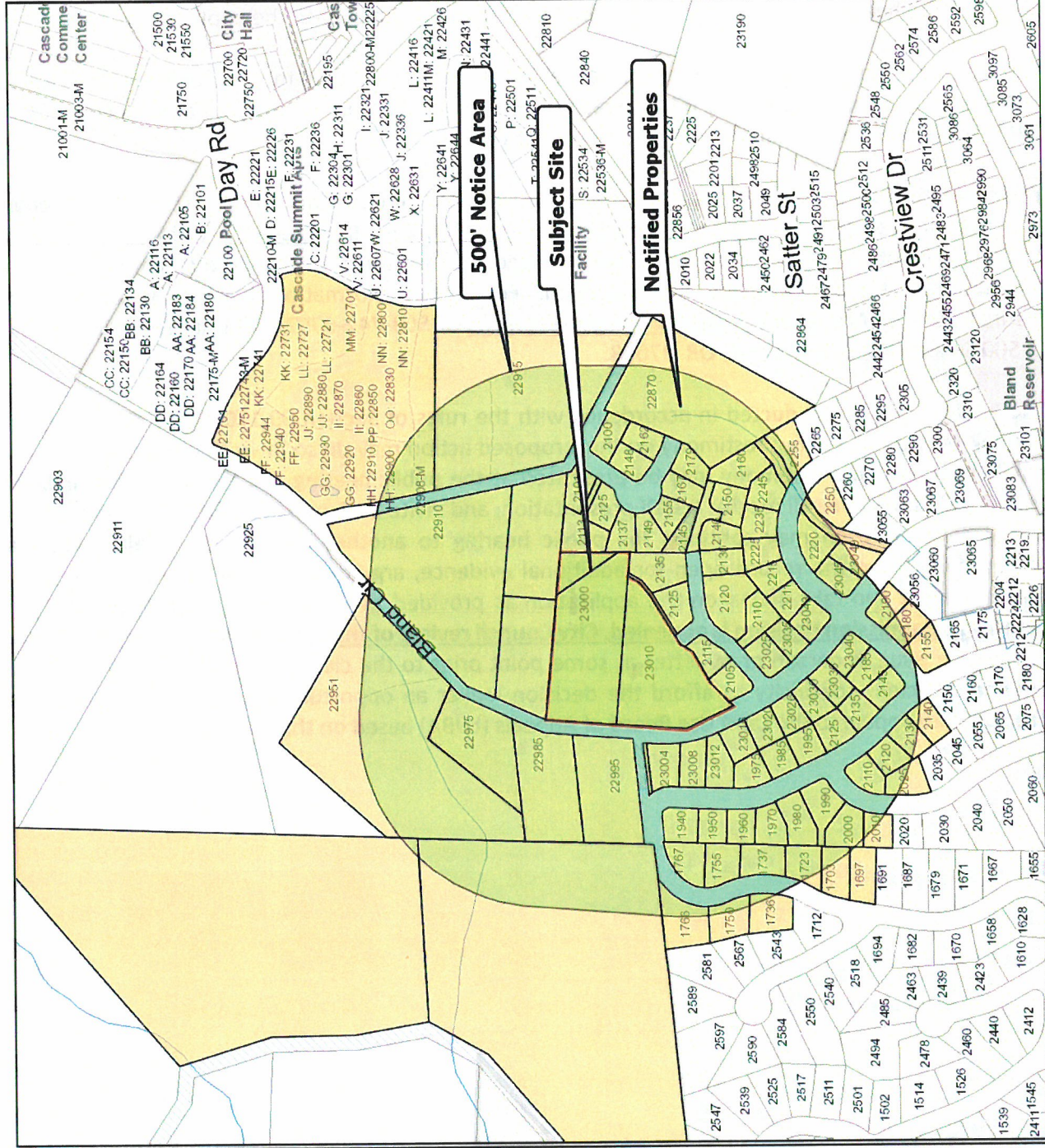

Scale 1:4,800 - 1 in = 400 ft
Scale is based on 8-1/2 x 11 paper size



Map created by: JARNOLD
Date Created: 13-Nov-19 03:53 PM

WEST LINN GIS

DISCLAIMER: This product is for informational purposes and may not have been prepared for, or be suitable for legal, engineering, or surveying purposes. Users of this information should review or consult the primary data and information sources to ascertain the usability of the information. Map scale is approximate. Source: West Linn GIS (Geographic Information System) MapOptrix.

PC-2

COMPLETENESS LETTER



CITY OF
West Linn

October 31, 2019

Emerio Design, LLC
ATTN: Steve Miller
6445 SW Fallbrook Place, STE: 100
Beaverton, OR 97008

SUBJECT: SUB-19-03 application for 15-lot Subdivision at 23000/23010 Bland Circle

Dear Mr. Miller:

You submitted this application on July 8, 2019 which was deemed incomplete on August 6, 2019. After reviewing the supplemental submittal, the Planning and Engineering Departments find that this application is now **complete**. The city has 120 days to exhaust all local review; that period ends February 17, 2020.

Please be aware that determination of a complete application does not guarantee a recommendation of approval from staff for your proposal as submitted – it signals that staff believes you have provided the necessary information for the Planning Commission to render a decision on your proposal.

A 20-day public notice will be prepared and mailed. This notice will identify the Planning Commission hearing date.

Please contact me at 503-742-6057, or by email at jarnold@westlinnoregon.gov if you have any questions or comments

Sincerely,

Jennifer Arnold
Associate Planner

PC-3

Applicant's Submittal

EMERIO *Design*

CIVIL ENGINEERS & PLANNERS

DATE: 7-08-2019

APPLICANT: Bland Circle, LLC
Attn: Ben Looney
511 Main Street, Suite 101
Oregon City, OR 97045
Ph.: (541) 404-8825
E-mail: ben@growthcc.com

PROPERTY OWNERS: Robert and Cameron Bauer
23000 Bland Circle
West Linn, OR 97068

John and Lynn Nilsen
23010 Bland Circle
West Linn, OR 97068

**CIVIL ENGINEER,
PLANNING &
SURVEYOR:** Emerio Design, LLC
Attn: Steve Miller
6445 SW Fallbrook Pl., Suite 100
Beaverton, OR 97008
(541) 318-7487
E-mail: stevem@emeriodesign.com

REQUEST: Approval of a 15-Lot Subdivision in the R-7 zone.

SITE LOCATION: 23000 and 23010 Bland Circle

ZONING: Single-Family Residential Detached and attached (R-7), City of West Linn, Oregon

SITE SIZE: 2.84 Acres

LEGAL DESCRIPTION: Tax Map 2S1E35B, Tax Lots 201, 400, and 404

LIST OF EXHIBITS:

1 - Detailed Plan Set

- 2 – Pre-Application Notes
- 3 – Neighborhood Meeting Notice
- 4 – Stormwater Management Report
- 5 – Geotechnical Report
- 6 – Arborist Report

WEST LINN APPLICABLE COMMUNITY DEVELOPMENT CODE (CDC) SECTIONS

CDC Chapter 12: (R-7 Zone)

CDC Chapter 48: Access, Egress and Circulation

CDC Chapter 85: Land Division

CDC Chapter 92: Required Improvements

I. INTRODUCTION

The applicant is applying to subdivide an approximately 2.84 – acre property in a manner that allows the applicant to provide a variety of lot sizes and housing types. A pre-application conference was held with the City to discuss the subdivision of this property on October 4, 2018 by the Applicant.

The subject property is located on the east side of Bland Circle approximately 110-feet north of Fircrest Drive. The property is located on a hill and the site slopes gently downward to the south/southwest. There are two (2) existing single-family residential homes on the property, one of which will be removed as part of the project. The site is irregular in shape, has undulating topography throughout, and is vegetated with a mix of trees, shrubs, and ornamental landscaping around the existing homes.

All adjacent properties are within the West Linn City limits and are zoned R-7. These properties are developed with single-family residential dwellings.

Brief re-cap of the project:

- 15-Lot Subdivision
- Single-family residential detached dwellings on each lot
- All houses will meet maximum height requirements for the R-7 zone
- Bland Circle will be improved along the site's frontage to City standards.
- All proposed local streets serving the project will be built to city standards, which will include parking on one-side of the street.
- The development will be developed to city standards. No exceptions, variances or adjustments are being requested.
- The minimum lot size in the R-7 zone is 7,000 square feet and all proposed lots meet or exceed the minimum lot size.

- A pre-application conference with the City of West Linn was already held for the project.
- No environmentally sensitive areas have been identified on the property.
- A minimum of 20% of the significant trees will be preserved with the development of the subdivision.

II. CONFORMANCE WITH CITY OF WEST LINN CODE APPROVAL CRITERIA

CHAPTER 12 SINGLE-FAMILY RESIDENTIAL DETACHED AND ATTACHED, R-7

12.030 PERMITTED USES

The following uses are permitted outright in this zone.

1. Single-family detached residential unit.

RESPONSE: The proposed use is single-family detached residential units, a use permitted outright in the R-7 zone. The applicant's proposal satisfies the requirements of this section.

12.070 DIMENSIONAL REQUIREMENTS, USES PERMITTED OUTRIGHT AND USES PERMITTED UNDER PRESCRIBED CONDITIONS

Except as may be otherwise provided by the provisions of this code, the following are the requirements for uses within this zone:

A. The minimum lot size shall be:

1. For a single-family detached unit, 7,000 square feet.

B. The minimum front lot line length or the minimum lot width at the front lot line shall be 35 feet.

C. The average minimum lot width shall be 35 feet.

RESPONSE: The sizes of the fifteen (15) lots proposed in the subdivision are between 7,045 square feet, and 10,958 square feet, with an average lot size of 7,688 square feet. As such, all fifteen (15) lots meet or exceed the 7,000-square foot minimum lot size. Except for the three (3) proposed "flag lots", all other proposed front lot lines will meet or exceed the 35-foot minimum front lot line length, as well as the minimum average lot width of 35 feet. The three (3) proposed flag lots meet the minimum frontage requirement for flag lots and will be addressed later in this narrative. Therefore, all fifteen (15) lots comply with the above criteria.

E. The minimum yard dimensions or minimum building setback areas from the lot line shall be:

1. For the front yard, 20 feet, except for steeply sloped lots where the provisions of CDC [41.010](#) shall apply.

2. For an interior side yard, seven and one-half feet.

- 3. *For a side yard abutting a street, 15 feet.*
- 4. *For a rear yard, 20 feet.*
- F. *The maximum building height shall be 35 feet, except for steeply sloped lots in which case the provisions of CDC [41.010](#) shall apply.*
- G. *The maximum lot coverage shall be 35 percent.*
- H. *The minimum width of an accessway to a lot which does not abut a street or a flag lot shall be 15 feet.*
- I. *The maximum floor area ratio shall be 0.45. Type I and II lands shall not be counted toward lot area when determining allowable floor area ratio, except that a minimum floor area ratio of 0.30 shall be allowed regardless of the classification of lands within the property. That 30 percent shall be based upon the entire property including Type I and II lands. Existing residences in excess of this standard may be replaced to their prior dimensions when damaged without the requirement that the homeowner obtain a non-conforming structures permit under Chapter [66](#) CDC.*
- J. *The sidewall provisions of Chapter [43](#) CDC shall apply.*

RESPONSE: No homes are being proposed at this time. All Yard dimensions, building height, lot coverage, floor area ratios and sidewall provisions will be verified at time of building permit submittal.

CHAPTER 48 – ACCESS, EGRESS AND CIRCULATION

48.025 ACCESS CONTROL

- A. *Purpose. The following access control standards apply to public, industrial, commercial and residential developments including land divisions. Access shall be managed to maintain an adequate level of service and to maintain the functional classification of roadways as required by the West Linn Transportation System Plan.*
- B. *Access control standards.*
 - 1. *Traffic impact analysis requirements. The City or other agency with access jurisdiction may require a traffic study prepared by a qualified professional to determine access, circulation and other transportation requirements.*

RESPONSE: The City has not required a traffic impact analysis due to the small size and low impacts of the proposed development.

- 2. *The City or other agency with access permit jurisdiction may require the closing or consolidation of existing curb cuts or other vehicle access points, recording of reciprocal access easements (i.e., for shared driveways), development of a frontage street, installation of traffic control devices, and/or other mitigation as a condition of granting an access permit, to ensure*

the safe and efficient operation of the street and highway system. Access to and from off-street parking areas shall not permit backing onto a public street.

RESPONSE: Each lot on the property will include a driveway to provide access to/from either the new proposed local street (i.e. Eleanor St.) and/or Bland Circle. Both are public streets either adjacent to the site or internal to the project with a local residential street designation. The City's spacing standards for driveways along residential streets has been maintained for all new driveway access locations. The proposed configuration will create a safe and efficient access configuration for each new driveway.

- 3. Access options. When vehicle access is required for development (i.e., for off-street parking, delivery, service, drive-through facilities, etc.), access shall be provided by one of the following methods (planned access shall be consistent with adopted public works standards and TSP). These methods are "options" as approved by the City Engineer.**
 - a) Option 1. Access is from an existing or proposed alley or mid-block lane. If a property has access to an alley or lane, direct access to a public street is not permitted.**
 - b) Option 2. Access is from a private street or driveway connected to an adjoining property that has direct access to a public street (i.e., "shared driveway"). A public access easement covering the driveway shall be recorded in this case to assure access to the closest public street for all users of the private street/drive.**
 - c) Option 3. Access is from a public street adjacent to the development lot or parcel. If practicable, the owner/developer may be required to close or consolidate an existing access point as a condition of approving a new access. Street accesses shall comply with the access spacing standards in subsection (B)(6) of this section.**

RESPONSE: The Applicant is proposing access to the site via Option 3. The proposed design limits curb cuts for access to the new lots proposed within this development. Each lot will take access to either the proposed new local street (i.e. Eleanor St.) or Bland Circle via individual or shared driveways. Shared driveways will be provided for the following lots: Lots 5 – 8, Lots 10 & 11, and Lots 12 & 15. All other proposed lots will have individual driveways. See sheet 8/12 for more detail on the driveway locations. The City's spacing standards for driveways along residential streets has been maintained for all new driveway access locations. The proposed configuration will create a safe and efficient access configuration for each new driveway.

- 4. Subdivisions fronting onto an arterial street. New residential land divisions fronting onto an arterial street shall be required to provide alleys or secondary (local or collector) streets for access to individual lots. When alleys or secondary streets cannot be constructed due to topographic or other physical constraints, access may be provided by consolidating driveways for clusters of two or more lots (e.g., includes flag lots and mid-block lanes).**

RESPONSE: The proposed development does not front onto an arterial street. The requirements of this section do not apply.

- 5. Double-frontage lots. When a lot or parcel has frontage onto two or more streets, access shall be provided first from the street with the lowest classification. For example, access shall be provided from a local street before a collector or arterial street. When a lot or parcel has**

frontage opposite that of the adjacent lots or parcels, access shall be provided from the street with the lowest classification.

RESPONSE: No double fronted lots will be created as part of this subdivision.

6. Access spacing.

a. The access spacing standards found in the adopted Transportation System Plan (TSP) shall be applicable to all newly established public street intersections and non-traversable medians. Deviation from the access spacing standards may be granted by the City Engineer if conditions are met as described in the access spacing variances section in the adopted TSP.

b. Private drives and other access ways are subject to the requirements of CDC 48.060.

RESPONSE: The Applicant's proposed driveway locations are shown on the site plan (see Sheet 8). The City's access spacing requirements for new driveways onto a residential local street have been maintained.

7. Number of access points. For single-family (detached and attached), two-family, and duplex housing types, one street access point is permitted per lot or parcel, when alley access cannot otherwise be provided; except that two access points may be permitted corner lots (i.e., no more than one access per street), subject to the access spacing standards in subsection (B)(6) of this section. The number of street access points for multiple family, commercial, industrial, and public/institutional developments shall be minimized to protect the function, safety and operation of the street(s) and sidewalk(s) for all users. Shared access may be required, in conformance with subsection (B)(8) of this section, in order to maintain the required access spacing, and minimize the number of access points.

RESPONSE: Except for Lots 5 and 6, which will be flag lots with a shared driveway, the Applicant is proposing only one access point for each single-family lot. Thus, new driveways will be created for 13 lots and two (2) lots will share a driveway.

8. Shared driveways. The number of driveway and private street intersections with public streets shall be minimized by the use of shared driveways with adjoining lots where feasible. The City shall require shared driveways as a condition of land division or site design review, as applicable, for traffic safety and access management purposes in accordance with the following standards:

a. Shared driveways and frontage streets may be required to consolidate access onto a collector or arterial street. When shared driveways or frontage streets are required, they shall be stubbed to adjacent developable parcels to indicate future extension. "Stub" means that a driveway or street temporarily ends at the property line, but may be extended in the future as the adjacent lot or parcel develops. "Developable" means that a lot or parcel is either vacant or it is likely to receive additional development (i.e., due to infill or redevelopment potential).

- b. Access easements (i.e., for the benefit of affected properties) shall be recorded for all shared driveways, including pathways, at the time of final plat approval or as a condition of site development approval.**
- c. Exception. Shared driveways are not required when existing development patterns or physical constraints (e.g., topography, lot or parcel configuration, and similar conditions) prevent extending the street/driveway in the future.**

RESPONSE: The Applicant is proposing only one (1) shared driveway for the development. An access easement will be created for lots 5 and 6 to allow for the shared driveway.

C. Street connectivity and formation of blocks required. In order to promote efficient vehicular and pedestrian circulation throughout the City, land divisions and large site developments shall produce complete blocks bounded by a connecting network of public and/or private streets, in accordance with the following standards:

- 1. Block length and perimeter. The maximum block length shall not exceed 800 feet or 1,800 feet along an arterial.**
- 2. Street standards. Public and private streets shall also conform to Chapter 92 CDC, Required Improvements, and to any other applicable sections of the West Linn Community Development Code and approved TSP.**
- 3. Exception. Exceptions to the above standards may be granted when blocks are divided by one or more pathway(s), in conformance with the provisions of CDC 85.200(C), Pedestrian and Bicycle Trails, or cases where extreme topographic (e.g., slope, creek, wetlands, etc.) conditions or compelling functional limitations preclude implementation, not just inconveniences or design challenges.**

RESPONSE: One new street is being proposed as part of the subdivision and it will be stubbed to the site's northern property boundary for its future extension. The proposed new street will intersect with Bland Circle and provide access to the City's surrounding residential street network.

Existing development patterns and topographic conditions preclude the extension of any new roadways through the site or within close proximity which could logically provide for future connectivity. Furthermore, Figure 12 of the West Linn Transportation System Plan – Recommended Local Street Connectivity Projects – does not identify a new street connection within or adjacent to this site. All street standards will be met as shown in the submitted plan set.

Due to the existing development pattern in the surrounding area, as well as the undulating topography, not new blocks are being created as part of this development proposal. Nevertheless, the applicant will be stubbing the new proposed local residential street to the site's northern property boundary, which will allow for its future extension to facilitate a new block in the neighborhood. Therefore, when the property to the north of the subject property redevelops, there will be an opportunity to establish a new block length of 800-feet by creating a new street connection with Weatherhill Road.

48.030 MINIMUM VEHICULAR REQUIREMENTS FOR RESIDENTIAL USES

- A. Direct individual access from single-family dwellings and duplex lots to an arterial street, as designated in the transportation element of the Comprehensive Plan, is prohibited for lots or parcels created after the effective date of this code where an alternate access is either available or is expected to be available by imminent development application. Evidence of alternate or future access may include temporary cul-de-sacs, dedications or stubouts on adjacent lots or parcels, or tentative street layout plans submitted at one time by adjacent property owner/developer or by the owner/developer, or previous owner/developer, of the property in question.**

In the event that alternate access is not available as determined by the Planning Director and City Engineer, access may be permitted after review of the following criteria:

- 1. Topography.**
- 2. Traffic volume to be generated by development (i.e., trips per day).**
- 3. Traffic volume presently carried by the street to be accessed.**
- 4. Projected traffic volumes.**
- 5. Safety considerations such as line of sight, number of accidents at that location, emergency vehicle access, and ability of vehicles to exit the site without backing into traffic.**
- 6. The ability to consolidate access through the use of a joint driveway.**
- 7. Additional review and access permits may be required by State or County agencies.**

RESPONSE: The Applicant is not proposing new access to any arterials; therefore, this subsection does not apply.

- B. When any portion of any house is less than 150 feet from the adjacent right-of-way, access to the home is as follows:**
- 1. One single-family residence, including residences with an accessory dwelling unit as defined in CDC 02.030, shall provide 10 feet of unobstructed horizontal clearance. Dual-track or other driveway designs that minimize the total area of impervious driveway surface are encouraged.**
 - 2. Two to four single-family residential homes equals a 14- to 20-foot-wide paved or all weather surface. Width shall depend upon adequacy of line of sight and number of homes.**
 - 3. Maximum driveway grade shall be 15 percent. The 15 percent shall be measured along the centerline of the driveway only. Variations require approval of a Class II variance by the Planning Commission pursuant to Chapter 75 CDC. Regardless, the last 18 feet in front of the garage shall be under 12 percent grade as measured along the centerline of the driveway only. Grades elsewhere along the driveway shall not apply.**

4. ***The driveway shall include a minimum of 20 feet in length between the garage door and the back of sidewalk, or, if no sidewalk is proposed, to the paved portion of the right-of-way.***

RESPONSE: The existing home to be retained on Lot 15, as well as all other future homes to be constructed on the proposed lots will be less than 150 feet from the adjacent right-of-way. All proposed accesses will provide 10 feet of unobstructed horizontal clearance. Where possible dual-track or other driveway designs that minimize the total area of impervious driveway surface will be used. The max driveway grade for all lots will not exceed 15 percent. All proposed driveways will include a minimum of 20 feet in length between the garage door and the back of sidewalk.

- C. ***When any portion of one or more homes is more than 150 feet from the adjacent right-of-way, the provisions of subsection B of this section shall apply in addition to the following provisions.***

1. ***A turnaround may be required as prescribed by the Fire Chief.***
2. ***Minimum vertical clearance for the driveway shall be 13 feet, six inches.***
3. ***A minimum centerline turning radius of 45 feet is required unless waived by the Fire Chief.***
4. ***There shall be sufficient horizontal clearance on either side of the driveway so that the total horizontal clearance is 20 feet.***

RESPONSE: The future homes to be constructed on Lots 6, 7, 11, and 12 will have a portion of the homes that are more than 150 feet from the adjacent right-of-way. It's not anticipated that a turnaround will be required for these homes as all driveways are less than 150 feet in length. All proposed driveways will be able to maintain a minimum vertical clearance of 13 feet, 6 inches and will have sufficient horizontal clearance on either side of the driveway so that the total horizontal clearance is 20 feet.

- D. ***Access to five or more single-family homes shall be by a street built to full construction code standards. All streets shall be public. This full street provision may only be waived by variance.***

RESPONSE: All proposed lots will take access via public streets built to full construction code standards.

- E. ***Access and/or service drives for multi-family dwellings shall be fully improved with hard surface pavement:***

1. ***With a minimum of 24-foot width when accommodating two-way traffic; or***
2. ***With a minimum of 15-foot width when accommodating one-way traffic. Horizontal clearance shall be two and one-half feet wide on either side of the driveway.***
3. ***Minimum vertical clearance of 13 feet, six inches.***
4. ***Appropriate turnaround facilities per Fire Chief's standards for emergency vehicles when the drive is over 150 feet long. Fire Department turnaround areas shall not exceed seven percent grade unless waived by the Fire Chief.***

5. The grade shall not exceed 10 percent on average, with a maximum of 15 percent.

6. A minimum centerline turning radius of 45 feet for the curve.

RESPONSE: The above criteria do not apply to the Applicant's proposal because no multi-family dwellings are being proposed as part of this development proposal.

F. Where on-site maneuvering and/or access drives are necessary to accommodate required parking, in no case shall said maneuvering and/or access drives be less than that required in Chapters 46 and 48 CDC.

RESPONSE: The above criterion does not apply to the Applicant's proposal because no On-site maneuvering areas are being proposed.

G. The number of driveways or curb cuts shall be minimized on arterials or collectors. Consolidation or joint use of existing driveways shall be required when feasible.

RESPONSE: The above criterion does not apply to the Applicant's proposal because no proposed driveways will be taking access from an arterial or collector street.

H. In order to facilitate through traffic and improve neighborhood connections, it may be necessary to construct a public street through a multi-family site.

RESPONSE: The above criterion does not apply to the Applicant's proposal because no proposed streets are being constructed through a multi-family site.

I. Gated accessways to residential development other than a single-family home are prohibited.

RESPONSE: Access to each lot will be provided to/from either Bland Circle or the new proposed street (i.e. Eleanor St.), which are both local residential streets, and will meet the minimum vehicular requirements of this subsection. No gates are being proposed.

48.060 WIDTH AND LOCATION OF CURB CUTS AND ACCESS SEPARATION REQUIREMENTS

A. Minimum curb cut width shall be 16 feet.

B. Maximum curb cut width shall be 36 feet, except along Highway 43 in which case the maximum curb cut shall be 40 feet. For emergency service providers, including fire stations, the maximum shall be 50 feet.

C. No curb cuts shall be allowed any closer to an intersecting street right-of-way line than the following:

1. On an arterial when intersected by another arterial, 150 feet.

2. On an arterial when intersected by a collector, 100 feet.

3. *On an arterial when intersected by a local street, 100 feet.*
 4. *On a collector when intersecting an arterial street, 100 feet.*
 5. *On a collector when intersected by another collector or local street, 35 feet.*
 6. *On a local street when intersecting any other street, 35 feet.*
- D. *There shall be a minimum distance between any two adjacent curb cuts on the same side of a public street, except for one-way entrances and exits, as follows:***
1. *On an arterial street, 150 feet.*
 2. *On a collector street, 75 feet.*
 3. *Between any two curb cuts on the same lot or parcel on a local street, 30 feet.*
- E. *A rolled curb may be installed in lieu of curb cuts and access separation requirements.***
- F. *Curb cuts shall be kept to the minimum, particularly on Highway 43. Consolidation of driveways is preferred. The standard on Highway 43 is one curb cut per business if consolidation of driveways is not possible.***
- G. *Adequate line of sight pursuant to engineering standards should be afforded at each driveway or accessway.***

RESPONSE: All streets serving the subdivision are local residential streets. All proposed curb cuts will meet the spacing requirements of this section and will be confirmed during the construction plan review prior to commencing construction of the subdivision.

CHAPTER 85 GENERAL PROVISIONS

85.170 SUPPLEMENTAL SUBMITTAL REQUIREMENTS FOR TENTATIVE SUBDIVISION OR PARTITION PLAN

- B. Transportation.**
1. *Centerline profiles with extensions shall be provided beyond the limits of the proposed subdivision to the point where grades meet, showing the finished grade of streets and the nature and extent of street construction. Where street connections are not proposed within or beyond the limits of the proposed subdivision on blocks exceeding 330 feet, or for cul-de-sacs, the tentative plat or partition shall indicate the location of easements that provide connectivity for bicycle and pedestrian use to accessible public rights-of-way.*
 2. **Traffic Impact Analysis (TIA).**
 - a. **Purpose.** *The purpose of this section of the code is to implement Section 660-012-0045(2)(e) of the State Transportation Planning Rule that requires the City to adopt a*

process to apply conditions to development proposals in order to minimize adverse impacts to and protect transportation facilities. This section establishes the standards for when a proposal must be reviewed for potential traffic impacts; when a Traffic Impact Analysis must be submitted with a development application in order to determine whether conditions are needed to minimize impacts to and protect transportation facilities; what must be in a Traffic Impact Study; and who is qualified to prepare the study.

- b. Typical average daily trips. The latest edition of the Trip Generation manual, published by the Institute of Transportation Engineers (ITE) shall be used as the standards by which to gauge average daily vehicle trips.*
- c. Traffic impact analysis requirements.*
 - 1) Preparation. A Traffic Impact Analysis shall be prepared by a professional engineer qualified under OAR 734-051-0040. The City shall commission the traffic analysis and it will be paid for by the applicant.*
 - 2) Transportation Planning Rule compliance. See CDC 105.050(D), Transportation Planning Rule Compliance.*
 - 3) Pre-application conference. The applicant will meet with West Linn Public Works prior to submitting an application that requires a traffic impact application. This meeting will determine the required elements of the TIA and the level of analysis expected.*

RESPONSE: The Applicant is not proposing a change in zoning or a plan amendment designation as a part of this land use application, therefore a Traffic Impact Analysis (TIA) is not required per this subsection.

Trip rates presented in the Institute of Transportation Engineer's (ITE) Trip Generation Manual, Ninth Edition, were utilized to estimate the number of vehicle trips per dwelling unit that are anticipated to be generated by the site. The site's trip generation is based on the ITE Single-Family Detached Housing land use (ITE Code 210) for weekdays during the peak hour of adjacent street traffic. It is estimated that 142 daily trips including 14 AM peak hour trips and 15 PM peak hour trips will be added to the local street network due to the proposed development. Due to the low volume of traffic being generated by the proposed subdivision, a full TIA is not been required, nor has one been requested by the City's Public Works staff.

C. Grading.

- 1. If areas are to be graded, a plan showing the location of cuts, fill, and retaining walls, and information on the character of soils shall be provided. The grading plan shall show proposed and existing contours at intervals per CDC 85.160(E)(2).*
- 2. The grading plan shall demonstrate that the proposed grading to accommodate roadway standards and create appropriate building sites is the minimum amount necessary.*

3. ***The grading plan must identify proposed building sites and include tables and maps identifying acreage, location and type of development constraints due to site characteristics such as slope, drainage and geologic hazards. For Type I, II, and III lands (refer to definitions in Chapter 02 CDC), the applicant must provide a geologic report, with text, figures and attachments as needed to meet the industry standard of practice, prepared by a certified engineering geologist and/or a geotechnical professional engineer, that includes:***
 - a. ***Site characteristics, geologic descriptions and a summary of the site investigation conducted;***
 - b. ***Assessment of engineering geological conditions and factors;***
 - c. ***Review of the City of West Linn’s Natural Hazard Mitigation Plan and applicability to the site; and***
 - d. ***Conclusions and recommendations focused on geologic constraints for the proposed land use or development activity, limitations and potential risks of development, recommendations for mitigation approaches and additional work needed at future development stages including further testing and monitoring.***

RESPONSE: As part of the application materials, the applicant has provided a grading and erosion control plan (see Sheet 7) showing the locations of cuts, fills, and retaining walls. The Applicant has also provided a detailed Geotechnical report that provides information on the character of the soils. Together, these documents demonstrate that the proposed grading plan to accommodate roadway standards and create appropriate building sites is the minimum amount necessary given the sites topographic and soil conditions. The Applicant’s proposal satisfies the above criteria and will be further reviewed with the civil plans prior to commencing any construction.

D. Water.

1. ***A plan for domestic potable water supply lines and related water service facilities, such as reservoirs, etc., shall be prepared by a licensed engineer consistent with the adopted Comprehensive Water System Plan and most recently adopted updates and amendments.***
2. ***Location and sizing of the water lines within the development and off-site extensions. Show on-site water line extensions in street stubouts to the edge of the site, or as needed to complete a loop in the system.***
3. ***Adequate looping system of water lines to enhance water quality.***
4. ***For all non-single-family developments, calculate fire flow demand of the site and demonstrate to the Fire Chief. Demonstrate to the City Engineer how the system can meet the demand.***

RESPONSE: A utility plan has been submitted by the Applicant as part of the overall application materials. The utility plan shows the location and sizing of the water lines, as well as on-site water line

extensions in street stubouts to the edge of the site, or as needed to complete a loop in the system. All proposed water improvements are included on the utility plan (see Sheet 8) of the land use application.

E. Sewer.

- 1. A plan prepared by a licensed engineer shall show how the proposal is consistent with the Sanitary Sewer Master Plan and subsequent updates and amendments. Agreement with that plan must demonstrate how the sanitary sewer proposal will be accomplished and how it is efficient. The sewer system must be in the correct zone.**
- 2. Sanitary sewer information will include plan view of the sanitary sewer lines, including manhole locations and depths. Show how each lot or parcel would be sewered.**
- 3. Sanitary sewer lines shall be located in the public right-of-way, particularly the street, unless the applicant can demonstrate why the alternative location is necessary and meets accepted engineering standards.**
- 4. Sanitary sewer line should be at a depth that can facilitate connection with downsystem properties in an efficient manner.**
- 5. The sanitary sewer line should be designed to minimize the amount of lineal feet in the system.**
- 6. The sanitary sewer line shall minimize disturbance of natural areas and, in those cases where that is unavoidable, disturbance shall be mitigated pursuant to the appropriate chapters (e.g., Chapter 32 CDC, Water Resource Area Protection).**
- 7. Sanitary sewer shall be extended or stubbed out to the next developable subdivision or a point in the street that allows for reasonable connection with adjacent or nearby properties.**
- 8. The sanitary sewer system shall be built pursuant to Department of Environmental Quality (DEQ), City, and Tri-City Service District sewer standards. This report should be prepared by a licensed engineer, and the applicant must be able to demonstrate the ability to satisfy these submittal requirements or standards at the pre-construction phase.**

RESPONSE: A utility plan has been submitted by the Applicant as part of the overall application materials. The utility plan shows the location and sizing of the sewer lines. Sanitary sewer will be extended or stubbed out to the next developable subdivision or to a point in the street that allows for reasonable connection with adjacent or nearby properties. The proposed sanitary sewer lines will be located to minimize disturbance to any potential natural areas; however, in those cases where that is unavoidable, disturbances will be kept to a minimum.

All proposed sewer improvements will be built pursuant to DEQ, City, and Tri-City Service District standards, and those improvements are included on the utility plan (see Sheet 8) of the land use application.

- F. Storm. A proposal shall be submitted for storm drainage and flood control including profiles of proposed drainageways with reference to the most recently adopted Storm Drainage Master Plan.**

RESPONSE: A utility plan has been submitted by the Applicant as part of the overall application materials. The utility plan shows the location and sizing of the stormwater lines. The public stormwater plan will include a water quality facility (i.e. pond) located at the southwestern corner of the site. Individual LIDA planters will also be located on each lot for the treatment/detention of the future homes according to City requirements. All proposed storm drainage improvements are included on the utility plan (see Sheet 8) of the land use application.

85.180 REDIVISION PLAN REQUIREMENT

A redivision plan shall be required for a partition or subdivision, where the property could be developed at a higher density, under existing/proposed zoning, if all services were available and adequate to serve the use.

RESPONSE: The property is being developed at the highest density allowed under applicable zoning, therefore a redivision plan is not required.

85.200 APPROVAL CRITERIA

No tentative subdivision or partition plan shall be approved unless adequate public facilities will be available to provide service to the partition or subdivision area prior to final plat approval and the Planning Commission or Planning Director, as applicable, finds that the following standards have been satisfied, or can be satisfied by condition of approval.

A. Streets.

- 1. General. The location, width and grade of streets shall be considered in their relation to existing and planned streets, to the generalized or reasonable layout of streets on adjacent undeveloped lots or parcels, to topographical conditions, to public convenience and safety, to accommodate various types of transportation (automobile, bus, pedestrian, bicycle), and to the proposed use of land to be served by the streets. The functional class of a street aids in defining the primary function and associated design standards for the facility. The hierarchy of the facilities within the network in regard to the type of traffic served (through or local trips), balance of function (providing access and/or capacity), and the level of use (generally measured in vehicles per day) are generally dictated by the functional class. The street system shall assure an adequate traffic or circulation system with intersection angles, grades, tangents, and curves appropriate for the traffic to be carried. Streets should provide for the continuation, or the appropriate projection, of existing principal streets in surrounding areas and should not impede or adversely affect development of adjoining lands or access thereto.***

To accomplish this, the emphasis should be upon a connected continuous pattern of local, collector, and arterial streets rather than discontinuous curvilinear streets and cul-de-sacs. Deviation from this pattern of connected streets should only be permitted in cases of

extreme topographical challenges including excessive slopes (35 percent-plus), hazard areas, steep drainageways, wetlands, etc. In such cases, deviations may be allowed but the connected continuous pattern must be reestablished once the topographic challenge is passed. Streets should be oriented with consideration of the sun, as site conditions allow, so that over 50 percent of the front building lines of homes are oriented within 30 degrees of an east-west axis.

Internal streets are the responsibility of the developer. All streets bordering the development site are to be developed by the developer with, typically, half-street improvements or to City standards prescribed by the City Engineer. Additional travel lanes may be required to be consistent with adjacent road widths or to be consistent with the adopted Transportation System Plan (TSP) and any adopted updated plans.

An applicant may submit a written request for a waiver of abutting street improvements if the TSP prohibits the street improvement for which the waiver is requested. Those areas with numerous (particularly contiguous) under-developed or undeveloped tracts will be required to install street improvements. When an applicant requests a waiver of street improvements and the waiver is granted, the applicant shall pay an in-lieu fee equal to the estimated cost, accepted by the City Engineer, of the otherwise required street improvements. As a basis for this determination, the City Engineer shall consider the cost of similar improvements in recent development projects and may require up to three estimates from the applicant. The amount of the fee shall be established prior to the Planning Commission's decision on the associated application. The in-lieu fee shall be used for in kind or related improvements.

Streets shall also be laid out to avoid and protect tree clusters and significant trees, but not to the extent that it would compromise connectivity requirements per this subsection (A)(1), or bring the density below 70 percent of the maximum density for the developable net area. The developable net area is calculated by taking the total site acreage and deducting Type I and II lands; then up to 20 percent of the remaining land may be excluded as necessary for the purpose of protecting significant tree clusters or stands as defined in CDC 55.100(B)(2).

RESPONSE: This site is located along Bland Circle approximately 120 feet north of Fircrest Drive. All streets, whether existing or proposed, are designated as local streets. The development of this site will not affect the connectivity of any existing or proposed streets. Aside from the extension of the proposed new local residential street through the site, Figure 12 of the West Linn Transportation System Plan – Recommended Local Street Connectivity Projects – does not identify a new street connection within or adjacent to this site.

2. *Right-of-way widths shall depend upon which classification of street is proposed. The right-of-way widths are established in the adopted TSP.*

RESPONSE: The site abuts Bland Circle along the southern property boundary. The Applicant is proposing a new local residential street to be extended through the site and stubbed to the site's northern property boundary. Both streets are designated as local streets. As part of the proposed development, the Applicant will be dedicating 7-feet of right-of-way for Bland Circle street to make necessary improvements along Bland Circle. The new proposed local residential street will be equipped

with a 52-foot right-of-way. There proposed local street will have two (2) travel lanes, planter strips, sidewalks on both sides located within the 52-foot right-of-way. Right-of-way for both streets meet the width requirements as determined by their functional classifications.

- 3. *Street widths. Street widths shall depend upon which classification of street is proposed. The classifications and required cross sections are established in the adopted TSP. The following table identifies appropriate street width (curb to curb) in feet for various street classifications. The desirable width shall be required unless the applicant or his or her engineer can demonstrate that site conditions, topography, or site design require the reduced minimum width. For local streets, a 12-foot travel lane may only be used as a shared local street when the available right of-way is too narrow to accommodate bike lanes and sidewalks.***

RESPONSE: One (1) new street or road is proposed with this land use application. As noted above, new proposed local residential street will be equipped with a 52-foot right-of-way. There proposed local street will have two (2) travel lanes, planter strips, sidewalks on both sides located within the 52-foot right-of-way.

Bland Circle is an existing street and it will continue to meet street width requirements for residential local streets with the dedication of 7-feet as part of this development proposal. Right-of-way for both streets meet the width requirements as determined by their functional classifications.

- 4. *The decision-making body shall consider the City Engineer's recommendations on the desired right-of-way width, pavement width and street geometry of the various street types within the subdivision after consideration by the City Engineer of the following criteria:***
 - a. *The type of road as set forth in the Transportation Master Plan.***
 - b. *The anticipated traffic generation.***
 - c. *On-street parking requirements.***
 - d. *Sidewalk and bikeway requirements.***
 - e. *Requirements for placement of utilities.***
 - f. *Street lighting.***
 - g. *Drainage and slope impacts.***
 - h. *Street trees.***
 - i. *Planting and landscape areas.***
 - j. *Existing and future driveway grades***
 - k. *Street geometry.***

1. Street furniture needs, hydrants.

RESPONSE: Aside from the 7-foot right-of-way dedication along Bland Circle and the associated improvements (i.e. sidewalk, planter strip and paving), the pre-application conference notes do not identify the need for any further improvements along Bland Circle. Eleanor Street has been designed to comply with all City standards and specification for a local residential street.

5. Additionally, when determining appropriate street width, the decision-making body shall consider the following criteria:

- a. When a local street is the only street serving a residential area and is expected to carry more than the normal local street traffic load, the designs with two travel and one parking lane are appropriate.***
- b. Streets intended to serve as signed but unstriped bike routes should have the travel lane widened by two feet.***
- c. Collectors should have two travel lanes and may accommodate some parking. Bike routes are appropriate.***
- d. Arterials should have two travel lanes. On-street parking is not allowed unless part of a Street Master Plan. Bike lanes are required as directed by the Parks Master Plan and Transportation Master Plan.***

RESPONSE: The proposed development will result in fifteen (15) new homes taking access to the existing surrounding transportation system. No arterial streets are adjacent to this proposal.

6. Reserve strips. Reserve strips or street plugs controlling the access to streets are not permitted unless owned by the City.

RESPONSE: The Applicant does not propose reserve strips or street plugs with this application. All rights-of-way will be dedicated to the edge of the adjoining properties.

7. Alignment. All streets other than local streets or cul-de-sacs, as far as practical, shall be in alignment with existing streets by continuations of the centerlines thereof. The staggering of street alignments resulting in "T" intersections shall, wherever practical, leave a minimum distance of 200 feet between the centerlines of streets having approximately the same direction and otherwise shall not be less than 100 feet.

RESPONSE: Except for extending the new proposed local residential street (i.e. Eleanor St.) through the site and stubbing it out at the northern property boundary, no other new streets or roads are proposed as part of this application. The centerline of the new proposed street will be in excess of 200-feet from the centerline of Fircrest Dr.

8. Future extension of streets. Where necessary to give access to or permit a satisfactory future subdivision of adjoining land, streets shall be extended to the boundary of the subdivision and the resulting dead-end streets may be approved without turnarounds.

(Temporary turnarounds built to Fire Department standards are required when the dead-end street is over 100 feet long.)

RESPONSE: As noted above, the proposed new local street (i.e. Eleanor St.) will be extended through the site as part of the development and stubbed to the sites northern property boundary to permit the satisfactory subdivision of adjoining land. The Applicant's proposal satisfies this criterion.

- 9. Intersection angles. Streets shall be laid out to intersect angles as near to right angles as practical, except where topography requires lesser angles, but in no case less than 60 degrees unless a special intersection design is approved. Intersections which are not at right angles shall have minimum corner radii of 15 feet along right-of-way lines which form acute angles. Right-of-way lines at intersections with arterial streets shall have minimum curb radii of not less than 35 feet. Other street intersections shall have curb radii of not less than 25 feet. All radii shall maintain a uniform width between the roadway and the right-of-way lines. The intersection of more than two streets at any one point will not be allowed unless no alternative design exists.**

RESPONSE: One (1) new intersection is being proposed as part of the Applicant's development proposal. The intersection will be with Bland Circle and the intersection angles will as near to right angles as practical given the existing conditions and topography. The Applicant's proposal satisfies the above criterion.

- 10. Additional right-of-way for existing streets. Wherever existing street rights-of-way adjacent to or within a tract are of inadequate widths based upon the standards of this chapter, additional right-of-way shall be provided at the time of subdivision or partition.**

RESPONSE: The applicant will be dedicating 7-feet of right-of-way for Bland Circle along the sites frontage.

11. Cul-de-sacs.

- a. New cul-de-sacs and other closed-end streets (not including stub streets intended to be connected) on sites containing less than five acres, or sites accommodating uses other than residential or mixed use development, are not allowed unless the applicant demonstrates that there is no feasible alternative due to:**
- 1) Physical constraints (e.g., existing development, the size or shape of the site, steep topography, or a fish bearing stream or wetland protected by Chapter 32 CDC), or**
 - 2) Existing easements or leases.**
- b. New cul-de-sacs and other closed-end streets, consistent with subsection (A)(11)(a) of this section, shall not exceed 200 feet in length or serve more than 25 dwelling units unless the design complies with all adopted Tualatin Valley Fire and Rescue (TVFR) access standards and adequately provides for anticipated traffic, consistent with the Transportation System Plan (TSP).**

- c. ***New cul-de-sacs and other closed-end streets (not including stub streets intended to be connected) on sites containing five acres or more that are proposed to accommodate residential or mixed use development are prohibited unless barriers (e.g., existing development, steep topography, or a fish bearing stream or wetland protected by Chapter 32 CDC, or easements, leases or covenants established prior to May 1, 1995) prevent street extensions. In that case, the street shall not exceed 200 feet in length or serve more than 25 dwelling units, and its design shall comply with all adopted TVFR access standards and adequately provide for anticipated traffic, consistent with the TSP.***
- d. ***Applicants for a proposed subdivision, partition or a multifamily, commercial or industrial development accessed by an existing cul-de-sac/closed-end street shall demonstrate that the proposal is consistent with all applicable traffic standards and TVFR access standards.***
- e. ***All cul-de-sacs and other closed-end streets shall include direct pedestrian and bicycle accessways from the terminus of the street to an adjacent street or pedestrian and bicycle accessways unless the applicant demonstrates that such connections are precluded by physical constraints or that necessary easements cannot be obtained at a reasonable cost.***
- f. ***All cul-de-sacs/closed-end streets shall terminate with a turnaround built to one of the following specifications (measurements are for the traveled way and do not include planter strips or sidewalks).***

RESPONSE: No cul-de-sacs are proposed as part of this land use application.

12. Street names. No street names shall be used which will duplicate or be confused with the names of existing streets within the City. Street names that involve difficult or unusual spellings are discouraged. Street names shall be subject to the approval of the Planning Commission or Planning Director, as applicable. Continuations of existing streets shall have the name of the existing street. Streets, drives, avenues, ways, boulevards, and lanes shall describe through streets. Place and court shall describe cul-de-sacs. Crescent, terrace, and circle shall describe loop or arcing roads.

RESPONSE: One new street is being proposed as part of this land use application. The Applicant is proposing to name the new street "Eleanor Street". Based on the Applicant's research of the City's existing street names, it does not appear that the name "Eleanor" would duplicate or be confused with names of existing streets within the City. Also, the proposed street name does not involve difficult or unusual spellings.

13. Grades and curves. Grades and horizontal/vertical curves shall meet the West Linn Public Works Design Standards.

RESPONSE: Any grades and/or horizontal/vertical curves will be designed to meet West Linn Public Works Design Standards.

14. Access to local streets. Intersection of a local residential street with an arterial street may be prohibited by the decision-making authority if suitable alternatives exist for providing interconnection of proposed local residential streets with other local streets. Where a subdivision or partition abuts or contains an existing or proposed major arterial street, the decision-making authority may require marginal access streets, reverse-frontage lots with suitable depth, visual barriers, noise barriers, berms, no-access reservations alongside and rear property lines, and/or other measures necessary for adequate protection of residential properties from incompatible land uses, and to ensure separation of through traffic and local traffic.

RESPONSE: The property does not abut nor contain an existing or proposed arterial street.

15. Alleys. Alleys shall be provided in commercial and industrial districts unless other permanent provisions for access to off-street parking and loading facilities are made as approved by the decision-making authority. While alley intersections and sharp changes in alignment should be avoided, the corners of necessary alley intersections shall have radii of not less than 10 feet. Alleys may be provided in residential subdivisions or multi-family projects. The decision to locate alleys shall consider the relationship and impact of the alley to adjacent land uses. In determining whether it is appropriate to require alleys in a subdivision or partition, the following factors and design criteria should be considered:

- a. The alley shall be self-contained within the subdivision. The alley shall not abut undeveloped lots or parcels which are not part of the project proposal. The alley will not stub out to abutting undeveloped parcels which are not part of the project proposal.**
- b. The alley will be designed to allow unobstructed and easy surveillance by residents and police.**
- c. The alley should be illuminated. Lighting shall meet the West Linn Public Works Design Standards.**
- d. The alley should be a semi-private space where strangers are tacitly discouraged.**
- e. Speed bumps may be installed in sufficient number to provide a safer environment for children at play and to discourage through or speeding traffic.**
- f. Alleys should be a minimum of 14 feet wide, paved with no curbs.**

RESPONSE: No alleys are proposed as part of this land use application.

16. Sidewalks. Sidewalks shall be installed per CDC 92.010(H), Sidewalks. The residential sidewalk width is six feet plus planter strip as specified below. Sidewalks in commercial zones shall be constructed per subsection (A)(3) of this section. See also subsection C of this section. Sidewalk width may be reduced with City Engineer approval to the minimum amount (e.g., four feet wide) necessary to respond to site constraints such as grades, mature trees, rock outcroppings, etc., or to match existing sidewalks or right-of-way limitations.

RESPONSE: The applicant proposes to install a sidewalk along the sites Bland Circle frontage, as well as provide sidewalks along both sides of the proposed new local street with the extension of the street through the site.

17. Planter strip. *The planter strip is between the curb and sidewalk providing space for a grassed or landscaped area and street trees. The planter strip shall be at least 6 feet wide to accommodate a fully matured tree without the boughs interfering with pedestrians on the sidewalk or vehicles along the curblines. Planter strip width may be reduced or eliminated, with City Engineer approval, when it cannot be corrected by site plan, to the minimum amount necessary to respond to site constraints such as grades, mature trees, rock outcroppings, etc., or in response to right-of-way limitations.*

RESPONSE: The applicant proposes to install a planter strip along the sites Bland Circle frontage, as well as provide planter strips along both sides of new proposed local street with the extension of the street through the site.

18. Streets and roads shall be dedicated without any reservations or restrictions.

RESPONSE: No reservations or restrictions are being proposed with the street dedications.

19. All lots in a subdivision shall have access to a public street. Lots created by partition may have access to a public street via an access easement pursuant to the standards and limitations set forth for such accessways in Chapter 48 CDC.

RESPONSE: All proposed lots created by the subdivision in this land use application will have access to a public street per City requirements.

20. Gated streets. **Gated streets are prohibited in all residential areas on both public and private streets. A driveway to an individual home may be gated.**

RESPONSE: No gated streets are being proposed as part of this land use application.

21. Entryway treatments and street isle design. *When the applicant desires to construct certain walls, planters, and other architectural entryway treatments within a subdivision, the following standards shall apply:*

- a. All entryway treatments except islands shall be located on private property and not in the public right-of-way.*
- b. Planter islands may be allowed provided there is no structure (i.e., brick, signs, etc.) above the curblines, except for landscaping. Landscaped islands shall be set back a minimum of 24 feet from the curblines of the street to which they are perpendicular.*
- c. All islands shall be in public ownership. The minimum aisle width between the curb and center island curbs shall be 14 feet. Additional width may be required as determined by the City Engineer.*

- d. Brick or special material treatments are acceptable at intersections with the understanding that the City will not maintain these sections except with asphalt overlay, and that they must meet the Americans with Disabilities Act (ADA) standards. They shall be laid out to tie into existing sidewalks at intersections.*
- e. Maintenance for any common areas and entryway treatments (including islands) shall be guaranteed through homeowner's association agreements, CC&Rs, etc.*
- f. Under Chapter 52 CDC, subdivision monument signs shall not exceed 32 square feet in area.*

RESPONSE: No entryway treatments are being proposed as part of this land use application; therefore, the above criteria do not apply to the applicant's request.

- 22. Based upon the determination of the City Manager or the Manager's designee, the applicant shall construct or cause to be constructed, or contribute a proportionate share of the costs, for all necessary off-site improvements identified by the transportation analysis commissioned to address CDC 85.170(B)(2) that are required to mitigate impacts from the proposed subdivision. The proportionate share of the costs shall be determined by the City Manager or Manager's designee, who shall assume that the proposed subdivision provides improvements in rough proportion to identified impacts of the subdivision. Off-site transportation improvements will include bicycle and pedestrian improvements as identified in the adopted City of West Linn TSP.**

RESPONSE: The City Manager has not identified the need for any off-site improvements related to the development of this property; therefore, the above criterion does not apply to the applicant's proposal.

B. Blocks and lots.

- 1. General. The length, width, and shape of blocks shall be designed with due regard for the provision of adequate building sites for the use contemplated; consideration of the need for traffic safety, convenience, access, circulation, and control; and recognition of limitations and opportunities of topography and solar access.*
- 2. Sizes. The recommended block size is 400 feet in length to encourage greater connectivity within the subdivision. Blocks shall not exceed 800 feet in length between street lines, except for blocks adjacent to arterial streets or unless topographical conditions or the layout of adjacent streets justifies a variation. Designs of proposed intersections shall demonstrate adequate sight distances to the City Engineer's specifications. Block sizes and proposed accesses must be consistent with the adopted TSP. Subdivisions of five or more acres that involve construction of a new street shall have block lengths of no more than 530 feet. If block lengths are greater than 530 feet, accessways on public easements or right-of-way for pedestrians and cyclists shall be provided not more than 330 feet apart. Exceptions can be granted when prevented by barriers such as topography, rail lines, freeways, pre-existing development, leases, easements or covenants that existed prior to May 1, 1995, or by requirements of Titles 3 and 13 of the UGMFP. If streets must cross*

water features protected pursuant to Title 3 UGMFP, provide a crossing every 800 to 1,200 feet unless habitat quality or the length of the crossing prevents a full street connection.

RESPONSE: One (1) new road is being proposed as part of this land use application. However, due to the existing development pattern in the surrounding area, as well as the sites topography, no new block lengths will be created with this development. Instead, when the proposed new street is extended with the development of the adjoining northern property, then a new block pattern will be established with a street connection to Weatherhill Road.

- 3. Lot size and shape. Lot or parcel size, width, shape, and orientation shall be appropriate for the location of the subdivision or partition, for the type of use contemplated, for potential utilization of solar access, and for the protection of drainageways, trees, and other natural features. No lot or parcel shall be dimensioned to contain part of an existing or proposed street. All lots or parcels shall be buildable. "Buildable" describes lots that are free of constraints such as wetlands, drainageways, etc., that would make home construction impossible. Lot or parcel sizes shall not be less than the size required by the zoning code unless as allowed by planned unit development (PUD).***

RESPONSE: The proposed lots created through this subdivision are each a minimum of 7,000 square feet in size to accommodate single family detached dwelling units in the R-7 zone. All proposed lots meet or exceed the minimum requirements for front lot line length, lot width and lot depth.

- 4. Depth and width of properties reserved or laid out for commercial and industrial purposes shall be adequate to provide for the off-street parking and service facilities required by the type of use proposed.***

RESPONSE: The applicant is proposing residential development for this site, so the above criterion is not applicable to the proposal.

- 5. Access. Access to subdivisions, partitions, and lots shall conform to the provisions of Chapter 48 CDC, Access, Egress and Circulation.***

RESPONSE: The subdivision, as proposed, conforms to the provisions of Chapter 48 CDC.

- 6. Double frontage lots and parcels. Double frontage lots and parcels have frontage on a street at the front and rear property lines. Double frontage lots and parcels shall be avoided except where they are essential to provide separation of residential development from arterial streets or adjacent non-residential activities, or to overcome specific disadvantages of topography and orientation. A planting screen or impact mitigation easement at least 10 feet wide, and across which there shall be no right of access, may be required along the line of building sites abutting such a traffic artery or other incompatible use.***

RESPONSE: This land use application does not include double frontage lots.

- 7. Lot and parcel side lines. The lines of lots and parcels, as far as is practicable, should run at right angles to the street upon which they face, except that on curved streets they should be radial to the curve.***

RESPONSE: All proposed lot lines and side parcel lines run at right angles to the street as far as is practicable.

- 8. Flag lots. Flag lots can be created where it can be shown that no other reasonable street access is possible to achieve the requested land division. A single flag lot shall have a minimum street frontage of 15 feet for its accessway. Where two to four flag lots share a common accessway, the minimum street frontage and accessway shall be eight feet in width per lot. Common accessways shall have mutual maintenance agreements and reciprocal access and utility easements. The following dimensional requirements shall apply to flag lots:**
 - a. Setbacks applicable to the underlying zone shall apply to the flag lot.**
 - b. Front yard setbacks may be based on the rear property line of the lot or parcel which substantially separates the flag lot from the street from which the flag lot gains access. Alternately, the house and its front yard may be oriented in other directions so long as some measure of privacy is ensured, or it is part of a pattern of development, or it better fits the topography of the site.**
 - c. The lot size shall be calculated exclusive of the accessway; the access strip may not be counted towards the area requirements.**
 - d. The lot depth requirement contained elsewhere in this code shall be measured from the rear property line of the lot or parcel which substantially separates the flag lot from the street from which the flag lot gains access.**
 - e. As per CDC 48.030, the accessway shall have a minimum paved width of 12 feet.**
 - f. If the use of a flag lot stem to access a lot is infeasible because of a lack of adequate existing road frontage, or location of existing structures, the proposed lot(s) may be accessed from the public street by an access easement of a minimum 15-foot width across intervening property.**

RESPONSE: The land use application proposes three (3) flag lots as part of the subdivision. Lots 5, 6, and 12 will be configured as a flag lots because no other reasonable street access is possible given the irregular shape of the parent parcel. Lot 12 is a single flag lot and it will have a minimum street frontage of 15.9-feet. Lots 5 and 6 will share a common accessway, with a minimum street frontage and accessway of eight feet. As proposed the flag lots comply with all city requirements.

- 9. Large lots or parcels. In dividing tracts into large lots or parcels which, at some future time, are likely to be redivided, the approval authority may:**
 - a. Require that the blocks be of such size and shape, and be so divided into building sites, and contain such easements and site restrictions as will provide for extension and opening of streets at intervals which will permit a subsequent division of any tract into lots or parcels of smaller size; or**

- b. Alternately, in order to prevent further subdivision or partition of oversized and constrained lots or parcels, restrictions may be imposed on the subdivision or partition plat.*

RESPONSE: The proposed lots are not likely to be re-divided as the density proposed and the lot sizes proposed are consistent with the maximum allowable density per the site's zoning.

C. Pedestrian and bicycle trails.

- 1. Trails or multi-use pathways shall be installed, consistent and compatible with federal ADA requirements and with the Oregon Transportation Planning Rule, between subdivisions, cul-de-sacs, and streets that would otherwise not be connected by streets due to excessive grades, significant tree(s), and other constraints natural or manmade. Trails shall also accommodate bicycle or pedestrian traffic between neighborhoods and activity areas such as schools, libraries, parks, or commercial districts. Trails shall also be required where designated by the Parks Master Plan.*
- 2. The all-weather surface (asphalt, etc.) trail should be eight feet wide at minimum for bicycle use and six feet wide at minimum for pedestrian use. Trails within 10 feet of a wetland or natural drainageway shall not have an all-weather surface, but shall have a soft surface as approved by the Parks Director. These trails shall be contained within a corridor dedicated to the City that is wide enough to provide trail users with a sense of defensible space. Corridors that are too narrow, confined, or with vegetative cover may be threatening and discourage use. Consequently, the minimum corridor width shall be 20 feet. Sharp curves, twists, and blind corners on the trail are to be avoided as much as possible to enhance defensible space. Deviations from the corridor and trail width are permitted only where topographic and ownership constraints require it.*
- 3. Defensible space shall also be enhanced by the provision of a three- to four-foot-high matte black chain link fence or acceptable alternative along the edge of the corridor. The fence shall help delineate the public and private spaces.*
- 4. The bicycle or pedestrian trails that traverse multi-family and commercial sites should follow the same defensible space standards but do not need to be defined by a fence unless required by the decision-making authority.*
- 5. Except for trails within 10 feet of a wetland or natural drainageway, soft surface or gravel trails may only be used in place of a paved, all-weather surface where it can be shown to the Planning Director that the principal users of the path will be recreational, non-destination-oriented foot traffic, and that alternate paved routes are nearby and accessible.*
- 6. The trail grade shall not exceed 12 percent except in areas of unavoidable topography, where the trail may be up to a 15 percent grade for short sections no longer than 50 feet. In any location where topography requires steeper trail grades than permitted by this section, the trail shall incorporate a short stair section to traverse the area of steep grades.*

RESPONSE: Sidewalks are provided along the frontages of the property. No pedestrian or bicycle trails are required.

D. Transit facilities.

1. The applicant shall consult with Tri-Met and the City Engineer to determine the appropriate location of transit stops, bus pullouts, future bus routes, etc., contiguous to or within the development site. If transit service is planned to be provided within the next two years, then facilities such as pullouts shall be constructed per Tri-Met standards at the time of development. More elaborate facilities, like shelters, need only be built when service is existing or imminent. Additional rights-of-way may be required of developers to accommodate buses.
2. The applicant shall make all transit-related improvements in the right-of-way or in easements abutting the development site as deemed appropriate by the City Engineer.
3. Transit stops shall be served by striped and signed pedestrian crossings of the street within 150 feet of the transit stop where feasible. Illumination of the transit stop and crossing is required to enhance defensible space and safety. ODOT approval may be required.
4. Transit stops should include a shelter structure bench plus eight feet of sidewalk to accommodate transit users, non-transit-related pedestrian use, and wheelchair users. Tri-Met must approve the final configuration.

RESPONSE: No transit facilities have been identified by Tri-Met or the City Development Engineer adjacent to this property. The above criteria do not apply to the Applicant's proposal.

E. Grading. Grading of building sites shall conform to the following standards unless physical conditions demonstrate the propriety of other standards:

1. ***All cuts and fills shall comply with the excavation and grading provisions of the Uniform Building Code and the following:***
 - a. ***Cut slopes shall not exceed one and one-half feet horizontally to one foot vertically (i.e., 67 percent grade).***
 - b. ***Fill slopes shall not exceed two feet horizontally to one foot vertically (i.e., 50 percent grade). Please see the following illustration.***
2. ***The character of soil for fill and the characteristics of lot and parcels made usable by fill shall be suitable for the purpose intended.***
3. ***If areas are to be graded (more than any four-foot cut or fill), compliance with CDC 85.170(C) is required.***

4. *The proposed grading shall be the minimum grading necessary to meet roadway standards, and to create appropriate building sites, considering maximum allowed driveway grades.*
5. *Type I lands shall require a report submitted by an engineering geologist, and Type I and Type II lands shall require a geologic hazard report.*
6. *Repealed by Ord. 1635.*
7. *On land with slopes in excess of 12 percent, cuts and fills shall be regulated as follows:*
 - a. *Toes of cuts and fills shall be set back from the boundaries of separate private ownerships at least three feet, plus one-fifth of the vertical height of the cut or fill. Where an exception is required from that requirement, slope easements shall be provided.*
 - b. *Cuts shall not remove the toe of any slope where a severe landslide or erosion hazard exists (as described in subsection (G)(5) of this section).*
 - c. *Any structural fill shall be designed by a registered engineer in a manner consistent with the intent of this code and standard engineering practices, and certified by that engineer that the fill was constructed as designed.*
 - d. *Retaining walls shall be constructed pursuant to Section 2308(b) of the Oregon State Structural Specialty Code.*
 - e. *Roads shall be the minimum width necessary to provide safe vehicle access, minimize cut and fill, and provide positive drainage control.*
8. *Land over 50 percent slope shall be developed only where density transfer is not feasible. The development will provide that:*
 - a. *At least 70 percent of the site will remain free of structures or impervious surfaces.*
 - b. *Emergency access can be provided.*
 - c. *Design and construction of the project will not cause erosion or land slippage.*
 - d. *Grading, stripping of vegetation, and changes in terrain are the minimum necessary to construct the development in accordance with subsection J of this section.*

RESPONSE: A geotechnical engineering report is included with this submittal. A grading plan has been included in the submitted plans which complies with all criteria of this subsection.

F. Water.

1. **A plan for domestic water supply lines or related water service facilities shall be prepared consistent with the adopted Comprehensive Water System Plan, plan update, March 1987, and subsequent superseding revisions or updates.**
2. **Adequate location and sizing of the water lines.**

3. Adequate looping system of water lines to enhance water quality.
4. For all non-single-family developments, there shall be a demonstration of adequate fire flow to serve the site.
5. A written statement, signed by the City Engineer, that water service can be made available to the site by the construction of on-site and off-site improvements and that such water service has sufficient volume and pressure to serve the proposed development's domestic, commercial, industrial, and fire flows.

RESPONSE: The Applicant proposes new water service connections for all proposed lots off of either Bland Circle or the proposed new local street, which will be extended through the site as part of this application. This proposal is consistent with the adopted Comprehensive Water System Plan. All proposed water improvements are included on the utility plan of the land use application.

G. Sewer.

1. *A plan prepared by a licensed engineer shall show how the proposal is consistent with the Sanitary Sewer Master Plan (July 1989). Agreement with that plan must demonstrate how the sanitary sewer proposal will be accomplished and how it is gravity-efficient. The sewer system must be in the correct basin and should allow for full gravity service.*
2. *Sanitary sewer information will include plan view of the sanitary sewer lines, including manhole locations and depth or invert elevations.*
3. *Sanitary sewer lines shall be located in the public right-of-way, particularly the street, unless the applicant can demonstrate why the alternative location is necessary and meets accepted engineering standards.*
4. *Sanitary sewer line should be at a depth that can facilitate connection with downsystem properties in an efficient manner.*
5. *The sanitary sewer line should be designed to minimize the amount of lineal feet in the system.*
6. *The sanitary sewer line shall avoid disturbance of wetland and drainageways. In those cases where that is unavoidable, disturbance shall be mitigated pursuant to Chapter 32 CDC, Water Resource Area Protection, all trees replaced, and proper permits obtained. Dual sewer lines may be required so the drainageway is not disturbed.*
7. *Sanitary sewer shall be extended or stubbed out to the next developable subdivision or a point in the street that allows for reasonable connection with adjacent or nearby properties.*
8. *The sanitary sewer system shall be built pursuant to DEQ, City, and Tri-City Service District sewer standards. The design of the sewer system should be prepared by a licensed*

engineer, and the applicant must be able to demonstrate the ability to satisfy these submittal requirements or standards at the pre-construction phase.

- 9. *A written statement, signed by the City Engineer, that sanitary sewers with sufficient capacity to serve the proposed development and that adequate sewage treatment plant capacity is available to the City to serve the proposed development.***

RESPONSE: The Applicant proposes new sewer service connections for all proposed lots off of either Bland Circle or the proposed new local street, which will be extended through the site as part of this application. All proposed sewer improvements are included on the utility plan of the land use application. The proposed sanitary sewer system is consistent with the Sanitary Sewer Master Plan, is in the correct basin and allows for full gravity service.

- H. *Storm detention and treatment. All proposed storm detention and treatment facilities comply with the standards for the improvement of public and private drainage systems located in the West Linn Public Works Design Standards, there will be no adverse off-site impacts caused by the development (including impacts from increased intensity of runoff downstream or constrictions causing ponding upstream), and there is sufficient factual data to support the conclusions of the submitted plan.***

RESPONSE: The Applicant's proposed stormwater detention and treatment design will include a public storm treatment/detention system consisting of water quality pond located at the sites southwestern corner along Bland Circle. All proposed storm drainage improvements are included on the utility plan Sheet 9 of the land use application.

- I. *Utility easements. Subdivisions and partitions shall establish utility easements to accommodate the required service providers as determined by the City Engineer. The developer of the subdivision shall make accommodation for cable television wire in all utility trenches and easements so that cable can fully serve the subdivision.***

RESPONSE: The applicant will establish utility easements as determined by the City Engineer and shown on the preliminary plat. All required easements will be recorded with the recording of the final plat.

- J. *Supplemental provisions.***

- 1. *Wetland and natural drainageways. Wetlands and natural drainageways shall be protected as required by Chapter 32 CDC, Water Resource Area Protection. Utilities may be routed through the protected corridor as a last resort, but impact mitigation is required.***

RESPONSE: The proposed subdivision does not impact any wetlands and/or natural drainageways, therefore, the above criterion does not apply to the Applicant's proposal.

- 2. *Willamette and Tualatin Greenways. The Willamette and Tualatin River Greenways shall be protected as required by Chapter 28 CDC, Willamette and Tualatin River Protection.***

RESPONSE: No greenways exist on this site or have been identified for dedication on this property. This property is not adjacent to the Willamette or Tualatin River and, therefore, a River Greenway is not feasible on this site.

3. Street trees. Street trees are required as identified in the appropriate section of the municipal code and Chapter 54 CDC.

RESPONSE: There are no existing street trees along the site's frontage of Bland Circle. The applicant will install street trees as a component of the frontage improvements on Bland Circle, as well as along both sides of the proposed new local street with the extension of the street through the site.

4. Lighting. All subdivision street or alley lights shall meet West Linn Public Works Design Standards.

RESPONSE: The applicant proposes to install new light fixtures along both the sites Bland Circle frontage, as well as along the proposed new local street with the extension of the street through the site. All required street lights will provide adequate lighting per current City standards. A photometric plan has been provided for review. See Sheet 12 for more detail on the lighting plan.

5. Dedications and exactions. The City may require an applicant to dedicate land and/or construct a public improvement that provides a benefit to property or persons outside the property that is the subject of the application when the exaction is roughly proportional. No exaction shall be imposed unless supported by a determination that the exaction is roughly proportional to the impact of development.

RESPONSE: As mentioned previously, the applicant will be dedicating 7-feet of right-of-way along the sites Bland Circle frontage. Additionally, right-of-way will be dedicated for the extension of the proposed new local residential street through the site in accordance with city standards and specifications.

6. Underground utilities. All utilities, such as electrical, telephone, and television cable, that may at times be above ground or overhead shall be buried underground in the case of new development. The exception would be in those cases where the area is substantially built out and adjacent properties have above-ground utilities and where the development site's frontage is under 200 feet and the site is less than one acre. High voltage transmission lines, as classified by Portland General Electric or electric service provider, would also be exempted. Where adjacent future development is expected or imminent, conduits may be required at the direction of the City Engineer. All services shall be underground with the exception of standard above-grade equipment such as some meters, etc.

RESPONSE: The Applicant's proposal complies with the above criterion because all new utility services are proposed to be located underground as part of the subdivision. With the exception of standard above-grade equipment, all services will be located underground pursuant to city standards and specifications.

7. Density requirement. Density shall occur at 70 percent or more of the maximum density allowed by the underlying zoning. These provisions would not apply when density is transferred from Type I and II lands as defined in CDC 02.030. Development of Type I or II

lands are exempt from these provisions. Land divisions of three lots or less would also be exempt.

RESPONSE: The R-7 zone permits a maximum density of 6.4 dwelling units per net acre. Net acre is defined as “the total gross acres less the public right-of-way and other acreage deductions, as applicable. The net acreage of this site after removal of dedicated right-of-way is 108,900 sq. ft. or 2.5 acres. At 6.4 dwelling units per net acre, the maximum number of dwelling units on this site is 16. This proposal is for a 15-lot subdivision. The proposed density for the site is within 70 percent of the maximum allowable density. The requirements of this section have been satisfied.

- 8. *Mix requirement. The “mix” rule means that developers shall have no more than 15 percent of the R-2.1 and R-3 development as single-family residential. The intent is that the majority of the site shall be developed as medium high-density multi-family housing.***

RESPONSE: This property is zoned R-7 and, therefore, the use of the parcel as an entirely residential development is permitted.

- 9. *Heritage trees/significant tree and tree cluster protection. All heritage trees, as defined in the municipal code, shall be saved. Diseased heritage trees, as determined by the City Arborist, may be removed at his/her direction. All non-heritage trees and clusters of trees (three or more trees with overlapping dripline; however, native oaks need not have an overlapping dripline) that are considered significant by virtue of their size, type, location, health, or numbers shall be saved pursuant to CDC 55.100(B)(2). Trees are defined per the municipal code as having a trunk six inches in diameter or 19 inches in circumference at a point five feet above the mean ground level at the base of the trunk.***

RESPONSE: The applicant has inventoried all trees on site and has consulted with the City’s arborist to determine which trees on site are significant. The applicant is proposing tree preservation consistent with these requirements, as detailed in the tree protection plan (Sheet 3). The trees identified as significant on this site will be retained with the development of the subdivision.

CHAPTER 92 REQUIRED IMPROVEMENTS FOR ALL DEVELOPMENT

The following improvements shall be installed at the expense of the developer and meet all City codes and standards:

A. Streets within subdivisions.

- 1. *All streets within a subdivision, including alleys, shall be graded for the full right-of-way width and improved to the City’s permanent improvement standards and specifications which include sidewalks and bicycle lanes, unless the decision-making authority makes the following findings:***
 - a. *The right-of-way cannot be reasonably improved in a manner consistent with City road standards or City standards for the protection of wetlands and natural drainageways.***
 - b. *The right-of-way does not provide a link in a continuous pattern of connected local streets, or, if it does provide such a link, that an alternative street link already exists or the applicant has proposed an alternative street which provides the necessary***

connectivity, or the applicant has proven that there is no feasible location on the property for an alternative street providing the link.

- 2. When the decision-making authority makes these findings, the decision-making authority may impose any of the following conditions of approval:**
 - a. A condition that the applicant initiate vacation proceedings for all or part of the right-of-way.**
 - b. A condition that the applicant build a trail, bicycle path, or other appropriate way.**

If the applicant initiates vacation proceedings pursuant to subsection (A)(2)(a) of this section, and the right-of-way cannot be vacated because of opposition from adjacent property owners, the City Council shall consider and decide whether to process a City-initiated street vacation pursuant to Chapter 271 ORS.

Construction staging area shall be established and approved by the City Engineer. Clearing, grubbing, and grading for a development shall be confined to areas that have been granted approval in the land use approval process only. Clearing, grubbing, and grading outside of land use approved areas can only be approved through a land use approval modification and/or an approved Building Department grading permit for survey purposes. Catch basins shall be installed and connected to pipe lines leading to storm sewers or drainageways.

RESPONSE: No vacation proceedings are being requested by the Applicant, nor are they being required by the City for the proposed 15-lot subdivision. All proposed streets within the subdivision, will be graded for the full right-of-way width and improved to the City's permanent improvement standards and specifications which include sidewalks and bicycle lanes, unless the decision-making authority determines otherwise.

- B. Extension of streets to subdivisions. The extension of subdivision streets to the intercepting paving line of existing streets with which subdivision streets intersect shall be graded for the full right-of-way width and improved to a minimum street structural section and width of 24 feet.**

RESPONSE: With the proposed 15-lot subdivision, the applicant will be extending a new local residential street through the site and stubbing it to the site's northern property boundary for its future extension. The proposed new local residential street will include intercepting of an existing paving line with which the subdivision street intersects, and it will be graded for the full right-of-way width and improved to a minimum street structural section and width of 24 feet. As such, the above criterion does not apply to the applicant's proposal.

- C. Local and minor collector streets within the rights-of-way abutting a subdivision shall be graded for the full right-of-way width and approved to the City's permanent improvement standards and specifications. The City Engineer shall review the need for street improvements and shall specify whether full street or partial street improvements shall be required. The City Engineer shall also specify the extent of storm drainage improvements required. The City Engineer shall be guided by the purpose of the City's systems development charge program in determining the extent of improvements which are the responsibility of the subdivider.**

RESPONSE: There are not collector streets abutting the proposed subdivision, therefore, the above criterion does not apply to the Applicant's request.

- D. Monuments. Upon completion of the first pavement lift of all street improvements, monuments shall be installed and/or reestablished at every street intersection and all points of curvature and points of tangency of street centerlines with an iron survey control rod. Elevation benchmarks shall be established at each street intersection monument with a cap (in a monument box) with elevations to a U.S. Geological Survey datum that exceeds a distance of 800 feet from an existing benchmark.**

RESPONSE: All required monuments will be installed with the development of the subdivision consistent with the City Standards and Specification pursuant to the above criterion.

- E. Storm detention and treatment. For Type I, II and III lands (refer to definitions in Chapter 02 CDC), a registered civil engineer must prepare a storm detention and treatment plan, at a scale sufficient to evaluate all aspects of the proposal, and a statement that demonstrates:**
- 1. The location and extent to which grading will take place indicating general contour lines, slope ratios, slope stabilization proposals, and location and height of retaining walls, if proposed.**
 - 2. All proposed storm detention and treatment facilities comply with the standards for the improvement of public and private drainage systems located in the West Linn Public Works Design Standards.**
 - 3. There will be no adverse off-site impacts, including impacts from increased intensity of runoff downstream or constrictions causing ponding upstream.**
 - 4. There is sufficient factual data to support the conclusions of the plan.**
 - 5. Per CDC 99.035, the Planning Director may require the information in subsections (E)(1), (2), (3) and (4) of this section for Type IV lands if the information is needed to properly evaluate the proposed site plan.**

RESPONSE: The subject property does not contain any Type I, II, III and/or IV lands per the City's definitions in Chapter 02 of the CDC. As such, the above criteria do not apply to the Applicant's proposal.

- F. Sanitary sewers. Sanitary sewers shall be installed to City standards to serve the subdivision and to connect the subdivision to existing mains.**
- 1. If the area outside the subdivision to be directly served by the sewer line has reached a state of development to justify sewer installation at the time, the Planning Commission may recommend to the City Council construction as an assessment project with such arrangement with the subdivider as is desirable to assure financing his or her share of the construction.**

- 2. *If the installation is not made as an assessment project, the City may reimburse the subdivider an amount estimated to be a proportionate share of the cost for each connection made to the sewer by property owners outside of the subdivision for a period of 10 years from the time of installation of the sewers. The actual amount shall be determined by the City Administrator considering current construction costs.***

RESPONSE: As mentioned previously in this narrative, the sanitary sewer lines will be installed to meet all City Standards and Specifications to serve the subdivision. As part of the submitted application materials, the Applicant has provided a detailed composite utility plan on Sheet 8 of the plan set that shows the line sizing and location for the proposed sewer lines.

- G. Water system. *Water lines with valves and fire hydrants providing service to each building site in the subdivision and connecting the subdivision to City mains shall be installed. Prior to starting building construction, the design shall take into account provisions for extension beyond the subdivision and to adequately grid the City system. Hydrant spacing is to be based on accessible area served according to the City Engineer's recommendations and City standards. If required water mains will directly serve property outside the subdivision, the City may reimburse the developer an amount estimated to be the proportionate share of the cost for each connection made to the water mains by property owners outside the subdivision for a period of 10 years from the time of installation of the mains. If oversizing of water mains is required to areas outside the subdivision as a general improvement, but to which no new connections can be identified, the City may reimburse the developer that proportionate share of the cost for oversizing. The actual amount and reimbursement method shall be as determined by the City Administrator considering current or actual construction costs.***

RESPONSE: As mentioned previously in this narrative, the water lines will be installed to meet all City Standards and Specifications to serve the subdivision. As part of the submitted application materials, the Applicant has provided a detailed composite utility plan on Sheet 8 of the plan set that shows the line sizing and location for the proposed water lines. Prior to starting building construction, the Applicant will work with the City's Engineering and Fire Departments to assure the design for the water system takes into account provisions for extension beyond the subdivision and to adequately grid the City system. Hydrant spacing will also be addressed at that time to make sure they are located in an accessible area pursuant to City Standards.

H. Sidewalks.

- 1. *Sidewalks shall be installed on both sides of a public street and in any special pedestrian way within the subdivision, except that in the case of primary or secondary arterials, or special type industrial districts, or special site conditions, the Planning Commission may approve a subdivision without sidewalks if alternate pedestrian routes are available. In the case of the double-frontage lots, provision of sidewalks along the frontage not used for access shall be the responsibility of the developer. Providing front and side yard sidewalks shall be the responsibility of the land owner at the time a request for a building permit is received. Additionally, deed restrictions and CC&Rs shall reflect that sidewalks are to be installed prior to occupancy and it is the responsibility of the lot or homeowner to provide the sidewalk, except as required above for double-frontage lots.***

2. *On local streets serving only single-family dwellings, sidewalks may be constructed during home construction, but a letter of credit shall be required from the developer to ensure construction of all missing sidewalk segments within four years of final plat approval pursuant to CDC [91.010\(A\)\(2\)](#).*
3. *The sidewalks shall measure at least six feet in width and be separated from the curb by a six-foot minimum width planter strip. Reductions in widths to preserve trees or other topographic features, inadequate right-of-way, or constraints, may be permitted if approved by the City Engineer in consultation with the Planning Director.*
4. *Sidewalks should be buffered from the roadway on high volume arterials or collectors by landscape strip or berm of three and one-half-foot minimum width.*
5. *The City Engineer may allow the installation of sidewalks on one side of any street only if the City Engineer finds that the presence of any of the factors listed below justifies such waiver:*
 - a. *The street has, or is projected to have, very low volume traffic density;*
 - b. *The street is a dead-end street;*
 - c. *The housing along the street is very low density; or*
 - d. *The street contains exceptional topographic conditions such as steep slopes, unstable soils, or other similar conditions making the location of a sidewalk undesirable.*

RESPONSE: The Applicant will be installing a sidewalk along the sites Bland Circle frontage, as well as along both sides of the proposed new local residential street with the extension of the street through the site. All proposed and required sidewalks will be installed pursuant to the City’s design standards and specifications. Should the developer choose to install the sidewalks with the construction of the homes, then a letter of credit will be provided to the City to ensure construction of all missing sidewalks within four years of the final plat approval.

- I. ***Bicycle routes. If appropriate to the extension of a system of bicycle routes, existing or planned, the Planning Commission may require the installation of separate bicycle lanes within streets and separate bicycle paths.***

RESPONSE: Per the City’s Transportation System Plan (TSP) there are no bicycle routes identified, either existing or planned, for the subject property.

- J. ***Street name signs. All street name signs and traffic control devices for the initial signing of the new development shall be installed by the City with sign and installation costs paid by the developer.***

RESPONSE: All required street signs, whether street names or traffic control signs, will be installed pursuant to the City’s Standards and Specifications as outlined in the above criterion. The Applicant is agreeable to paying the installation costs associated with the installation of the required signage.

- K. Dead-end street signs. Signs indicating “future roadway” shall be installed at the end of all discontinued streets. Signs shall be installed by the City per City standards, with sign and installation costs paid by the developer.**

RESPONSE: The Applicant is proposing to terminate the proposed new local residential street in a “stubbed” street design. A barricade will be installed at the end of the street and any required signage will be installed consistent with the City’s development codes.

- L. Signs indicating future use shall be installed on land dedicated for public facilities (e.g., parks, water reservoir, fire halls, etc.). Sign and installation costs shall be paid by the developer.**

RESPONSE: No public facilities are being proposed as part of this development request, therefore, the above criterion does not apply to the Applicant’s proposal.

- M. Street lights. Street lights shall be installed and shall be served from an underground source of supply. The street lighting shall meet IES lighting standards. The street lights shall be the shoe-box style light (flat lens) with a 30-foot bronze pole in residential (non-intersection) areas. The street light shall be the cobra head style (drop lens) with an approximate 50-foot (sized for intersection width) bronze pole. The developer shall submit to the City Engineer for approval of any alternate residential, commercial, and industrial lighting, and alternate lighting fixture design. The developer and/or homeowners association is required to pay for all expenses related to street light energy and maintenance costs until annexed into the City.**

RESPONSE: All required street lights will be installed and will be served from an underground source of supply. All required street lighting will meet IES lighting standards and the street light will be the “shoe-box” style light (i.e. flat lens).

- N. Utilities. The developer shall make necessary arrangements with utility companies or other persons or corporations affected for the installation of underground lines and facilities. Electrical lines and other wires, including but not limited to communication, street lighting, and cable television, shall be placed underground.**

RESPONSE: Consistent with the above criterion, the Applicant’s developer will make all necessary arrangements with the franchised utility companies or other persons or corporations affected for the installation of underground lines and facilities. Electrical lines and other wires, including but not limited to communication, street lighting, and cable television, will be placed underground as required by the City’s Community Development Code (CDC).

- O. Curb cuts and driveways. Curb cuts and driveway installations are not required of the subdivider at the time of street construction, but, if installed, shall be according to City standards. Proper curb cuts and hard-surfaced driveways shall be required at the time buildings are constructed.**

RESPONSE: All curb cuts and driveway installations will be installed at the time buildings are constructed on the lots. However, should the developer decide to install some curb cuts and driveways at the time of street construction, then, if installed, they will be installed according to City standards.

- P. *Street trees.* Street trees shall be provided by the City Parks and Recreation Department in accordance with standards as adopted by the City in the Municipal Code. The fee charged the subdivider for providing and maintaining these trees shall be set by resolution of the City Council.**

RESPONSE: The Applicant agrees to install all required street trees pursuant to the above criterion by working with the City's Parks and Recreation Department to obtain the necessary street trees. Additionally, the Applicant is agreeable to paying the fees set by resolution of the City Council for providing and maintain the requires street trees.

- Q. *Joint mailbox facilities shall be provided in all residential subdivisions, with each joint mailbox serving at least two, but no more than eight, dwelling units. Joint mailbox structures shall be placed in the street right-of-way adjacent to roadway curbs. Proposed locations of joint mailboxes shall be designated on a copy of the tentative plan of the subdivision, and shall be approved as part of the tentative plan approval. In addition, sketch plans for the joint mailbox structures to be used shall be submitted and approved by the City Engineer prior to final plat approval.***

RESPONSE: The Applicant will work with the US Postal Service (USPS) to identify a strategic location for two (2) joint mailbox facilities to serve the proposed 15-lot subdivision. The joint mailbox facilities will be installed in the street right-of-way adjacent to the roadway curbs. As part of the tentative plan approval, the Applicant requests, as a condition of any final approval, that the required sketch plans for the joint mailbox structures to be used shall be submitted and approved by the City Engineer prior to final plat approval.

92.030 IMPROVEMENT PROCEDURES

In addition to other requirements, improvements installed by the developer, either as a requirement of these regulations or at the developer's own option, shall conform to the requirements of this title and permanent improvement standards and specifications adopted by the City and shall be installed in accordance with the following procedure:

- A. *Improvement work shall not be commenced until plans have been checked for adequacy and approved by the City. To the extent necessary for evaluation of the proposal, the improvement plans may be required before approval of the tentative plan of a subdivision or partition. Plans shall be prepared in accordance with the requirements of the City.***
- B. *Improvement work shall not be commenced until the City has been notified in advance, and if work has been discontinued for any reason, it shall not be resumed until the City has been notified.***
- C. *Improvements shall be constructed under the Engineer. The City may require changes in typical sections and details in the public interest if unusual conditions arise during construction to warrant the change.***
- D. *All underground utilities, sanitary sewers, and storm drains installed in streets by the subdivider or by any utility company shall be constructed prior to the surfacing of the streets. Stubs for service connections for underground utilities and sanitary sewers shall be placed to a***

length obviating the necessity for disturbing the street improvements when service connections are made.

E. A digital and mylar map showing all public improvements as built shall be filed with the City Engineer upon completion of the improvements.

RESPONSE: All requirements and improvements installed by the developer, either as a requirement of the City's CDC regulations or at the developer's own option, will conform to the requirements of this title and permanent improvement standards and specifications adopted by the City and will be installed in accordance with the above procedures. The Applicant is agreeable, as a condition of any final approval, that all improvements be installed in accordance with all City standards and specifications adopted by the City.

99.038.E(5) Neighborhood Association Meeting Submittal Requirements: Submitting an audiotape of the meeting is an application requirement.

RESPONSE: The applicant contacted the Savana Oaks Neighborhood Association (SONA) to get a copy of the audiotape for the neighborhood meeting the applicant attended to present the proposed subdivision. I was informed by Roberta Schwarz, President Designee, that they do not record their meetings. However, Mrs. Schwarz provided the applicant with the meeting minutes from the meeting and the applicant has submitted those to the City with the application. Since SONA does not record their meeting, the applicant will not be able to provide a recording of the SONA meeting attended for this proposal. Aside from the audio recording, all other information has been provided.

SUMMARY AND CONCLUSION

Based upon the application materials submitted herein, the Applicant respectfully requests approval from the City's Planning Department of this application for a 15-lot residential subdivision.

EMERIO *Design*

CIVIL ENGINEERS & PLANNERS

Stormwater Management Report Bland Circle Subdivision 15-Lot Subdivision at 23000 & 23010 Bland Circle West Linn, Oregon

Emerio Project Number: 0540-001
City of West Linn Permit Numbers: TBD
Date: 07/08/2019

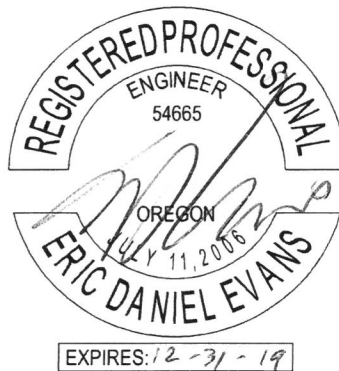

Prepared For:
Ben Looney
Bland Circle LLC
511 Main Street, Suite 101
Oregon City, OR 97045
ben@growthcc.com
(541) 404-8825

Prepared By:
Eric Evans, PE
Emerio Design, LLC
6445 SW Fallbrook Pl, Suite 100
Beaverton, Oregon 97008
eric@emeriodesign.com
(503) 746-8812

Table of Contents:

APPENDIX A

- (1) Vicinity Map

APPENDIX B

- (1) Soils Maps—"Soils Survey for Clackamas County"

APPENDIX C

- (1) Basin Area Tabulated Data
- (2) HydroCAD Output – Detention Storm Events
- (3) HydroCAD Output – Conveyance Flow

APPENDIX D

- (1) Pre-Developed Site Map
- (2) Post-Developed Site Map
- (3) WES Detail SWM FC-6.0

Project Overview and Description:

Size and location of project site (vicinity map): The current site is located in the south part of West Linn on the east side of Bland Circle, approximately 200 feet north of the intersection of Fircrest Drive & Bland Circle. Three lots will be divided into fifteen lots. The proposed site is 3.45 acres and will encompass roughly 60,689 SF of impervious onsite improvements and 3,917 SF offsite impervious improvement. Reference the vicinity map provided in Appendix A(1).

Property Zoning: The property is zoned R7 (Residential 7,000 SF lots).

Type of Development/Proposed Improvements: The proposed development will consist of a public street, and new homes and driveways will be constructed on each lot.

Existing vs. post-construction conditions: the current (existing) site condition consists of under-developed forested/vegetated lots with two houses, attached garages, and their associated driveways and outbuildings.

Watershed Description: The site drainage area presently sheet flows west toward Bland Circle and into the existing stormwater system in Bland Circle flowing south. In the post-developed condition, the site impervious flows will be treated onsite and discharged into the stormwater pipe that will connect to the existing stormwater pipe system in Bland Circle. Drainage basin areas are shown in Appendix D(2).

Soil Classification:

The NRCS soil survey of Clackamas County, Oregon classifies the onsite soils as Jory silty clay loam, Nekia silty clay loam, and Saum loam. The associated hydrologic group of these soils is C, see Appendix B(1). A curve number of 74 is used for pre-developed pervious surfaces and 98 and 86 are used for impervious and pervious surfaces.

Methodology:

To satisfy stormwater requirements, a water quality/quantity pond will be used. The pond will be placed at the southwest portion of the site adjacent to Bland Circle.

The pond will provide water quality for the proposed right-of-way (ROW) and all lots. Detention for the site will be provided by the storage volume of the proposed onsite pond. The proposed grading will retain the general existing drainage pattern for pervious areas of the site. An upstream basin currently flowing south along the Bland Circle frontage of the proposed project will be routed through the stormwater facility; however, detention will only be provided for the increased runoff due to development of this project and some right-of-way improvements.

Water Quality

The proposed pond is based on the standard City of Portland detention pond and the Water Environment Services (WES) standard detail SWM FC-6.0 (see Appendix D(3)). Stormwater runoff will enter the pond, slowly filter down through an 18" layer of amended soil before reaching a perforated pipe within a 12" section of drain rock to be routed to the orifice control structure for the pond. The peak water

surface elevation during the water quality storm for the pond is below the first ditch inlet; therefore, the volume of runoff during the water quality design storm will be fully treated (Appendix C(2)).

Quantity Control/Detention

As required by the City of West Linn, detention will be provided for the 2, 5, 10, and 25-year design storms within the pond. The pond volumes are shown in Table 1:

Elevation (ft)	Area (SF)	Cumulative Detention Storage (CF)
530.5	2,208	0
531.0	2,609	1,204
532	3,015	4,016
533	3,075	7,061
534	4,035	10,616
535	4,095	14,681

Return Period	Pre-Developed Site Discharge (CFS)	Post-Developed Site Discharge (CFS)
2-Year	0.87	0.87
5-Year	1.53	1.51
10-Year	2.11	2.11
25-Year	2.90	2.74

The outflow rate of the pond is controlled for the 2-year through 25-year design storm events via two orifices in a flow control structure: a 4.5" diameter orifice set at an elevation of 527.82' and an 8.7" orifice set at an elevation of 531.69'. Both orifices are set in an orifice plate between two ditch inlets per City of West Linn standard drawing number WL-610 and 611. The first ditch inlet is set at the peak water surface elevation of the water quality design storm. The second ditch inlet is set at 532.80' in the event of flows greater than the 25-year design storm. The pond will have a minimum of 1 foot of freeboard above the 25-year peak water surface elevation.

In the event of flows during the 100-year storm event and/or failure of the flow control and secondary ditch inlet structures, an emergency overflow manhole with a metal cage trash rack set at the 25-year peak water surface elevation will allow for conveyance of the pond. See conveyance section this page.

As shown in the Table 2, the water quality/quantity pond will limit the post-developed peak flow rates to the pre-developed peak flow rates for corresponding storm events.

Stormwater Conveyance

Onsite conveyance will be by means of 12" storm water pipe in Satter Street routing all the way to the discharge point in the existing utility easement south of this site. For conservatism, the total post-developed flow rate with no detention within proposed stormwater pipe was used to analyze the lowest potential pipe design slope at 0.5% during the conveyance design storm. See Appendix C(4) for HydroCAD flow rates developed during the 100-year 24-hr conveyance design storm event.

Analysis:

The following design assumptions were utilized in this design.

Design Storm: Water quality storm = **0.83" in 24 hours**
 2-year 24-hour storm = **2.5" in 24 hours**
 5-year 24-hour storm = **3.0" in 24 hours**
 10-year 24-hour storm = **3.4" in 24 hours**
 25-year 24-hour storm = **3.9" in 24 hours**
 100-year 24-hour storm = **4.5" in 24 hours**

Computation methods and software utilized in the design were from HydroCAD V-10.

Curve numbers utilized in the design were 98 for impervious areas, 86 for pervious areas, and 74 for predeveloped pervious areas.

Engineering Conclusions:

The design of the proposed stormwater management facilities satisfies the pollution reduction, conveyance and detention standards required by the 2010 City of West Linn Public Works Design Standards.

Appendix A:

Appendix A(1)
Vicinity Map

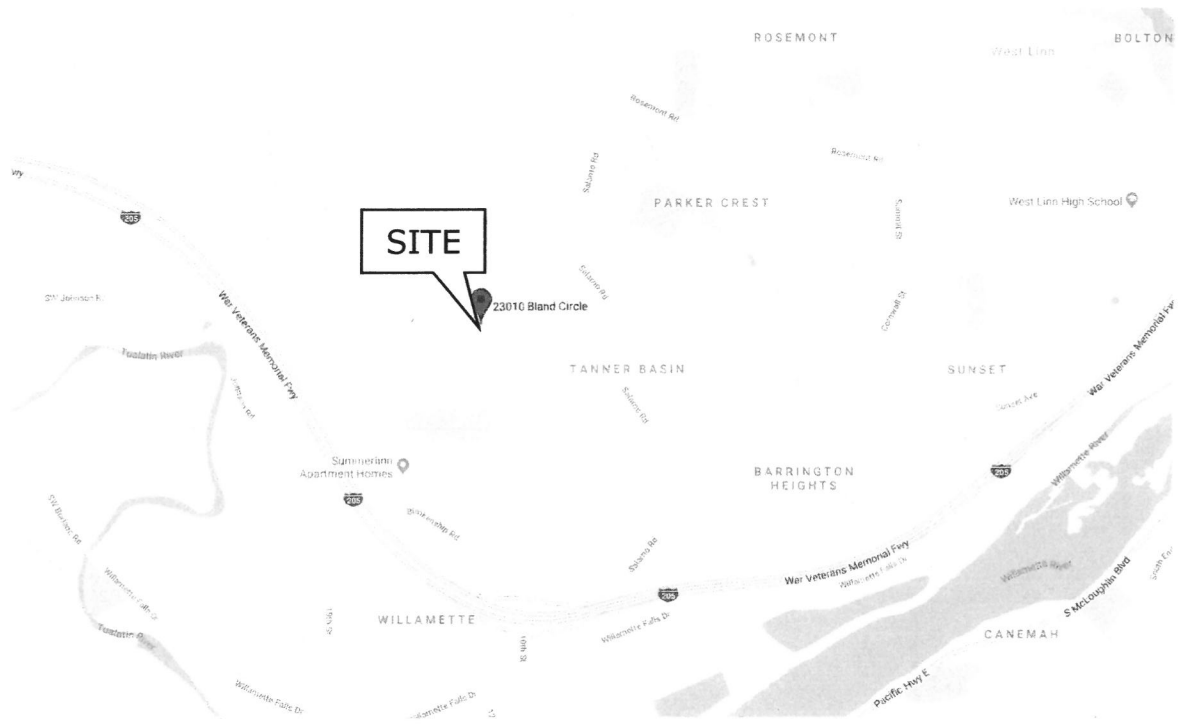

Appendix B:

Appendix B(1)
Soil Classification



Tables - Hydrologic Soil Group - Summary By Map Unit

Summary by Map Unit - Clackamas County Area, Oregon (OR610)

Summary by Map Unit - Clackamas County Area, Oregon (OR610)

Map unit symbol	Map unit name	Rating	Acres in AOI	Percent of AOI	
45C	Jory silty clay loam, 8 to 15 percent slopes	C	2.4	39.2%	
64C	Nekia silty clay loam, 8 to 15 percent slopes	C	1.1	17.3%	
78B	Saum silt loam, 3 to 8 percent slopes	C	0.6	10.5%	
78C	Saum silt loam, 8 to 15 percent slopes	C	2.0	33.1%	
Totals for Area of Interest			6.2	100.0%	

Appendix C:

Basin #	Name	Total Area SF	Total Area Acres	Qty of Lots	Lot Impervious SF	ROW/Tract Imp SF	Total Impervious SF	Total Pervious (Calc'd) SF
100	Pre-Developed Onsite	151,892	3.49	1	2,500	0	2,500	149,392
101	Post-Developed Onsite	151,892	3.49	15	37,500	20,996	58,496	93,396
200	Upstream Flows	258,223	5.93	3	7,500	14,005	21,505	236,718

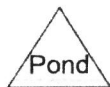
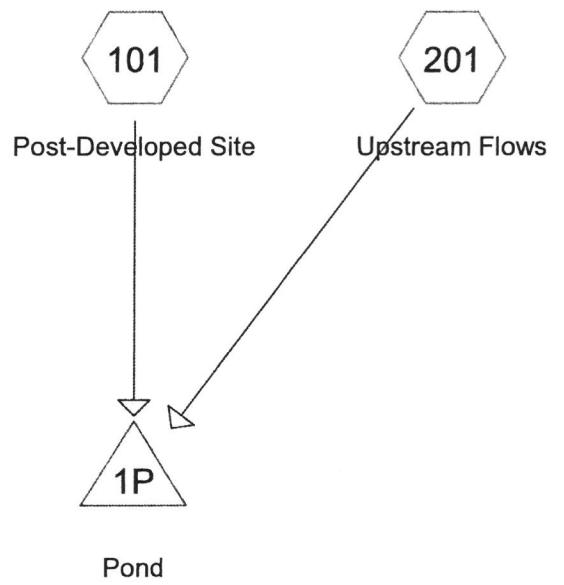
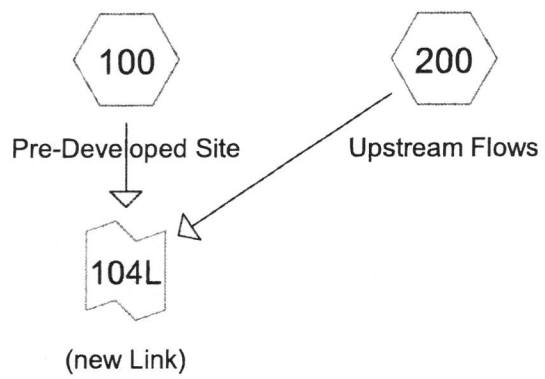

Summary for Subcatchment 100: Pre-Developed Site

Runoff = 0.30 cfs @ 8.01 hrs, Volume= 8,045 cf, Depth= 0.64"

Runoff by SBUH method, Split Pervious/Imperv., Time Span= 0.00-40.00 hrs, dt= 0.01 hrs
 Type IA 24-hr 2-Year Rainfall=2.50"

Area (sf)	CN	Description
* 2,500	98	roofs
149,392	74	>75% Grass cover, Good, HSG C
151,892	74	Weighted Average
149,392	74	98.35% Pervious Area
2,500	98	1.65% Impervious Area

Tc (min)	Length (feet)	Slope (ft/ft)	Velocity (ft/sec)	Capacity (cfs)	Description
5.2	100	0.1350	0.32		Sheet Flow, Grass: Short n= 0.150 P2= 2.50"
4.8	525	0.1350	1.84		Shallow Concentrated Flow, Woodland Kv= 5.0 fps
10.0	625	Total			

Subcatchment 100: Pre-Developed Site

Hydrograph

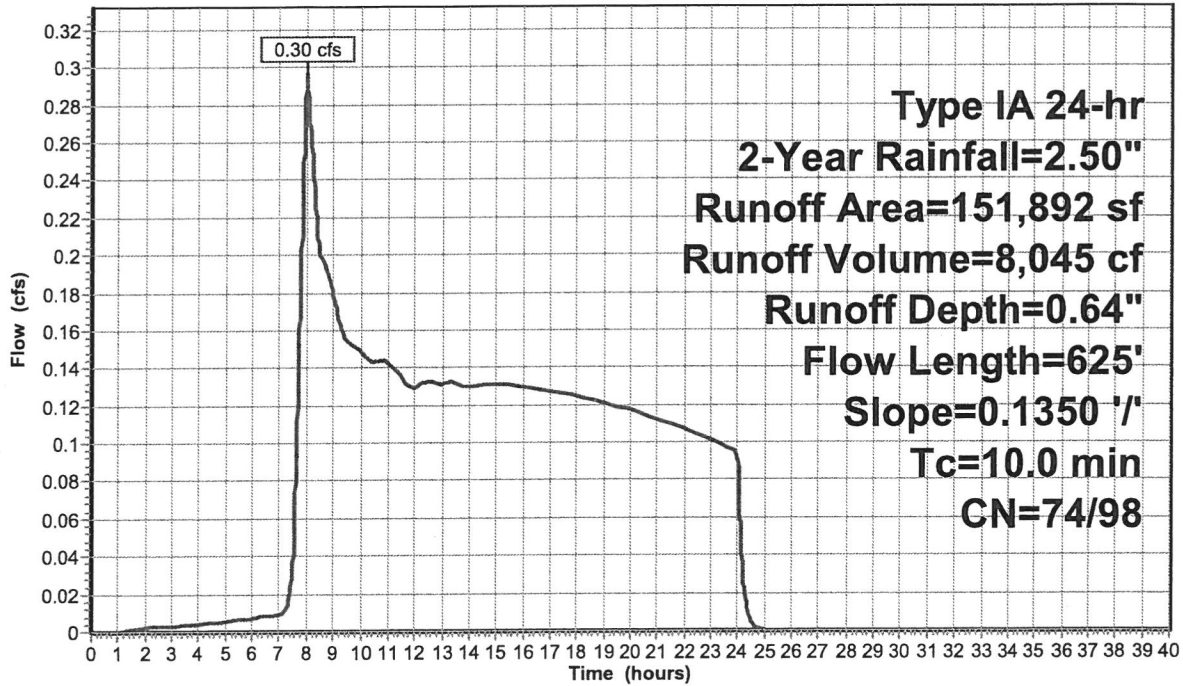

Summary for Subcatchment 101: Post-Developed Site

Runoff = 1.39 cfs @ 7.92 hrs, Volume= 20,747 cf, Depth= 1.64"

Runoff by SBUH method, Split Pervious/Imperv., Time Span= 0.00-40.00 hrs, dt= 0.01 hrs
 Type IA 24-hr 2-Year Rainfall=2.50"

	Area (sf)	CN	Description
*	37,500	98	lots
*	7,602	98	sidewalks
*	13,394	98	ROW
	93,396	86	<50% Grass cover, Poor, HSG C
	151,892	91	Weighted Average
	93,396	86	61.49% Pervious Area
	58,496	98	38.51% Impervious Area

Tc (min)	Length (feet)	Slope (ft/ft)	Velocity (ft/sec)	Capacity (cfs)	Description
5.0					Direct Entry,

Subcatchment 101: Post-Developed Site

Hydrograph

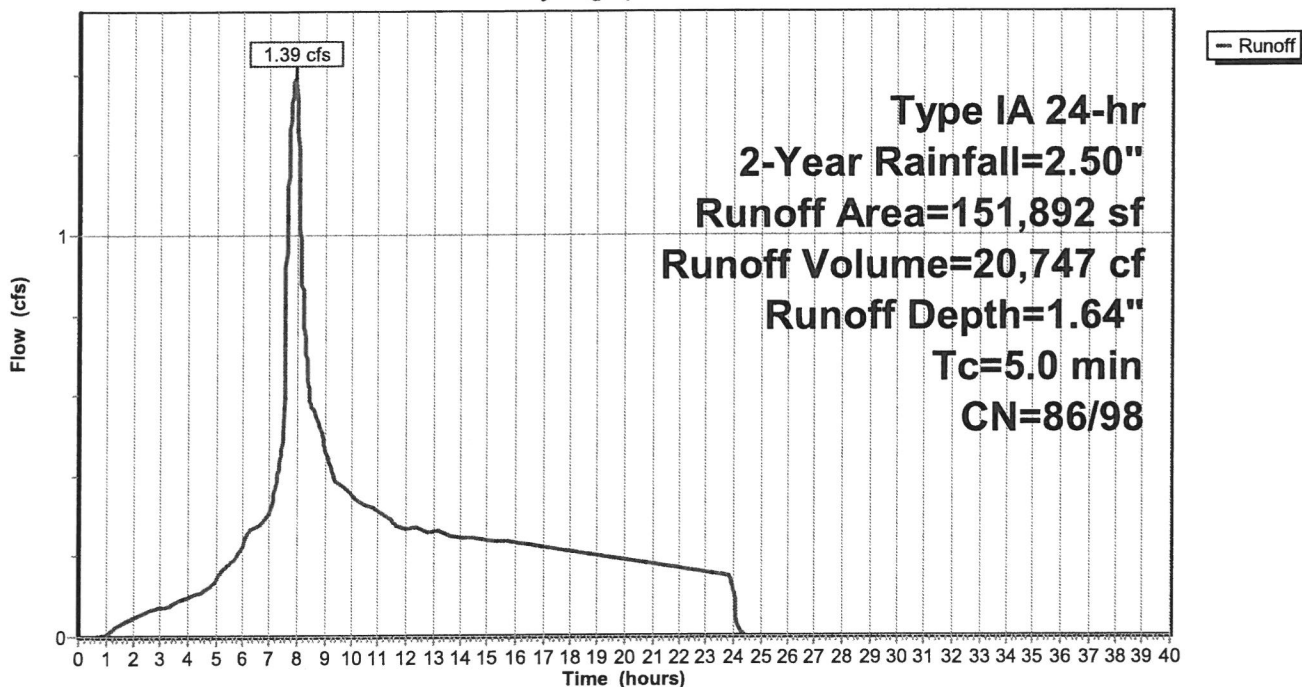

Summary for Subcatchment 200: Upstream Flows

Runoff = 0.58 cfs @ 8.01 hrs, Volume= 15,525 cf, Depth= 0.72"

Runoff by SBUH method, Split Pervious/Imperv., Time Span= 0.00-40.00 hrs, dt= 0.01 hrs
 Type IA 24-hr 2-Year Rainfall=2.50"

	Area (sf)	CN	Description
*	7,500	98	3 lots, impervious area
	240,635	74	>75% Grass cover, Good, HSG C
*	10,088	98	Ex. ROW
	258,223	76	Weighted Average
	240,635	74	93.19% Pervious Area
	17,588	98	6.81% Impervious Area

Tc (min)	Length (feet)	Slope (ft/ft)	Velocity (ft/sec)	Capacity (cfs)	Description
15.0					Direct Entry,

Subcatchment 200: Upstream Flows

Hydrograph

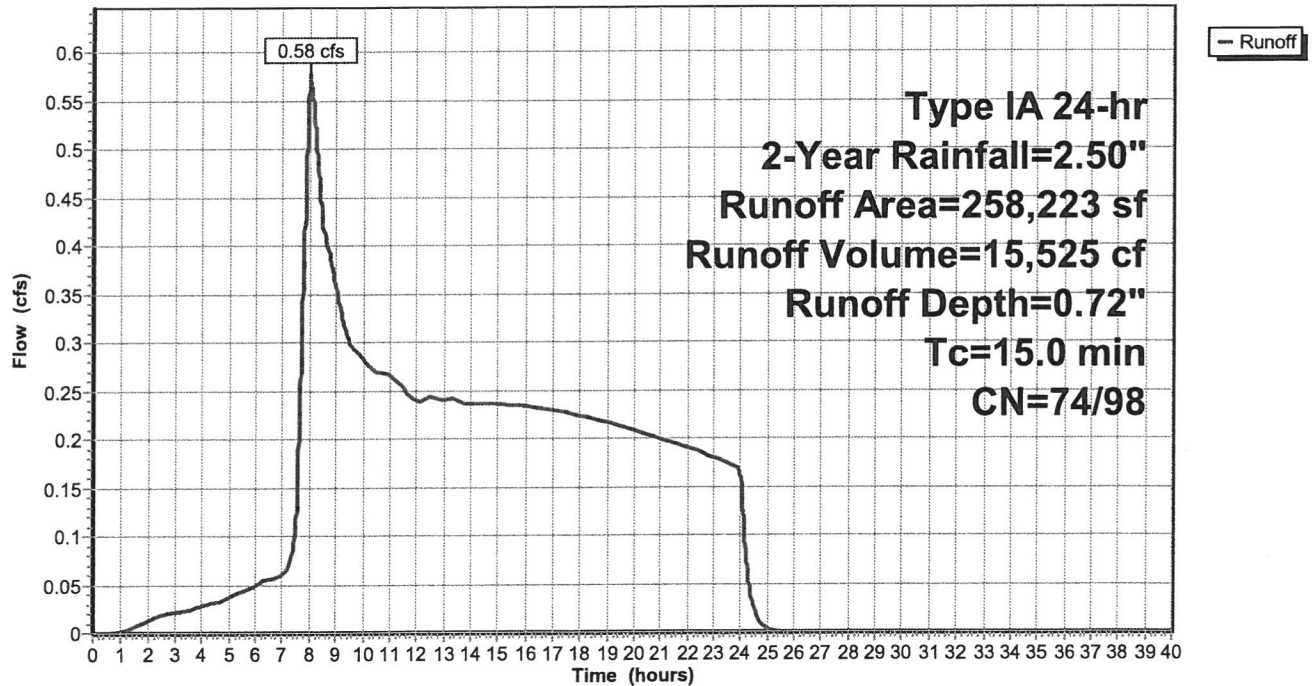

Summary for Subcatchment 201: Upstream Flows

Runoff = 0.62 cfs @ 8.01 hrs, Volume= 16,068 cf, Depth= 0.75"

Runoff by SBUH method, Split Pervious/Imperv., Time Span= 0.00-40.00 hrs, dt= 0.01 hrs
 Type IA 24-hr 2-Year Rainfall=2.50"

	Area (sf)	CN	Description
*	7,500	98	3 lots, impervious area
	236,718	74	>75% Grass cover, Good, HSG C
*	3,917	98	frontage new ROW
*	10,088	98	Ex. ROW
<hr/>			
	258,223	76	Weighted Average
	236,718	74	91.67% Pervious Area
	21,505	98	8.33% Impervious Area

Tc (min)	Length (feet)	Slope (ft/ft)	Velocity (ft/sec)	Capacity (cfs)	Description
15.0					Direct Entry,

Subcatchment 201: Upstream Flows

Hydrograph

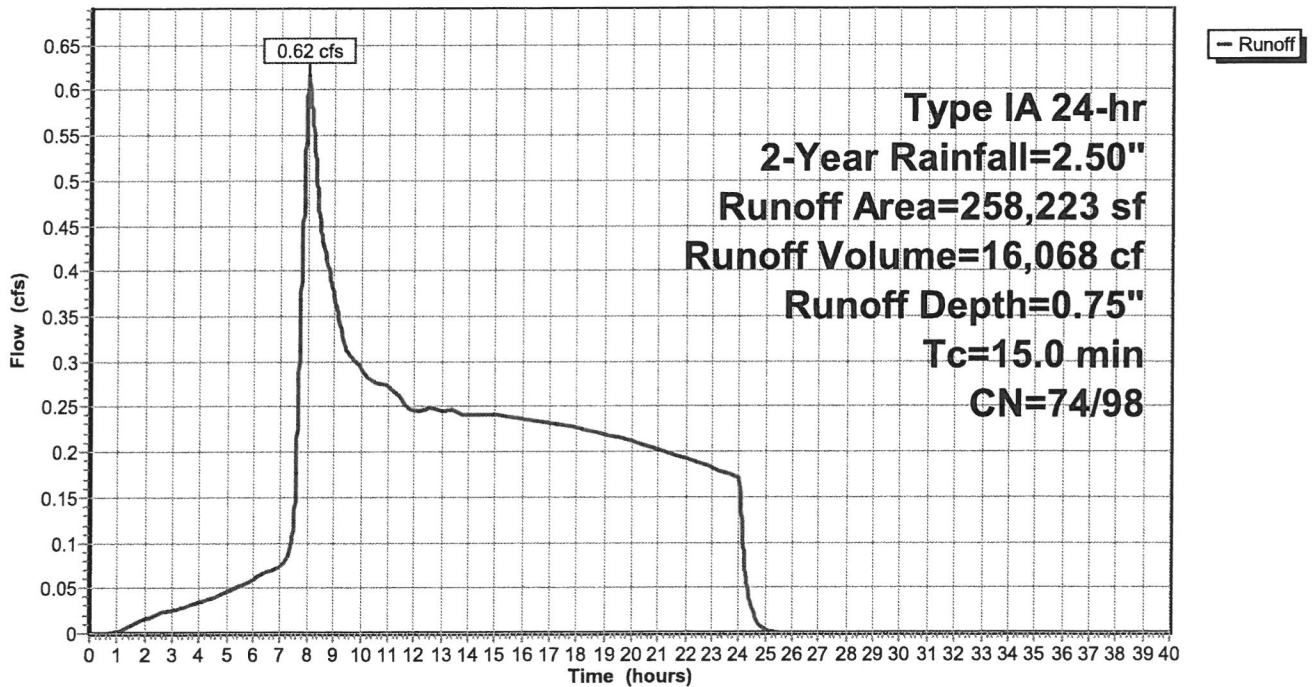

Summary for Pond 1P: Pond

Inflow Area = 410,115 sf, 19.51% Impervious, Inflow Depth = 1.08" for 2-Year event
 Inflow = 1.98 cfs @ 8.00 hrs, Volume= 36,815 cf
 Outflow = 0.87 cfs @ 8.95 hrs, Volume= 36,815 cf, Atten= 56%, Lag= 57.5 min
 Primary = 0.87 cfs @ 8.95 hrs, Volume= 36,815 cf
 Secondary = 0.00 cfs @ 0.00 hrs, Volume= 0 cf
 Tertiary = 0.00 cfs @ 0.00 hrs, Volume= 0 cf

Routing by Stor-Ind method, Time Span= 0.00-40.00 hrs, dt= 0.01 hrs
 Peak Elev= 531.77' @ 8.95 hrs Surf.Area= 2,921 sf Storage= 3,332 cf

Plug-Flow detention time= 35.1 min calculated for 36,806 cf (100% of inflow)
 Center-of-Mass det. time= 35.1 min (820.5 - 785.4)

Volume	Invert	Avail.Storage	Storage Description
#1	530.50'	14,681 cf	Custom Stage Data (Prismatic) Listed below (Recalc)
Elevation (feet)	Surf.Area (sq-ft)	Inc.Store (cubic-feet)	Cum.Store (cubic-feet)
530.50	2,208	0	0
531.00	2,609	1,204	1,204
532.00	3,015	2,812	4,016
533.00	3,075	3,045	7,061
534.00	4,035	3,555	10,616
535.00	4,095	4,065	14,681

Device	Routing	Invert	Outlet Devices
#1	Primary	529.00'	15.0" Round Culvert L= 20.0' RCP, square edge headwall, Ke= 0.500 Inlet / Outlet Invert= 529.00' / 528.90' S= 0.0050 ' /' Cc= 0.900 n= 0.013, Flow Area= 1.23 sf
#2	Device 1	527.82'	4.4" Vert. Low Orifice C= 0.600
#3	Device 2	530.50'	2.000 in/hr Exfiltration over Surface area
#4	Device 2	530.72'	24.0" x 24.0" Horiz. Ditch Inlet #1 C= 0.600 Limited to weir flow at low heads
#5	Device 1	531.70'	8.6" Vert. High Orifice C= 0.600
#6	Secondary	532.87'	24.0" x 24.0" Horiz. Ditch Inlet #2 C= 0.600 Limited to weir flow at low heads
#7	Tertiary	532.87'	48.0" Horiz. Overflow Manhole C= 0.600 Limited to weir flow at low heads

Primary OutFlow Max=0.86 cfs @ 8.95 hrs HW=531.77' (Free Discharge)

- 1=Culvert (Passes 0.86 cfs of 8.65 cfs potential flow)
- 2=Low Orifice (Orifice Controls 0.85 cfs @ 8.01 fps)
- 3=Exfiltration (Passes < 0.14 cfs potential flow)
- 4=Ditch Inlet #1 (Passes < 19.73 cfs potential flow)
- 5=High Orifice (Orifice Controls 0.02 cfs @ 0.90 fps)

Secondary OutFlow Max=0.00 cfs @ 0.00 hrs HW=530.50' (Free Discharge)

- 6=Ditch Inlet #2 (Controls 0.00 cfs)

Tertiary OutFlow Max=0.00 cfs @ 0.00 hrs HW=530.50' (Free Discharge)

- 7=Overflow Manhole (Controls 0.00 cfs)

Pond 1P: Pond

Hydrograph

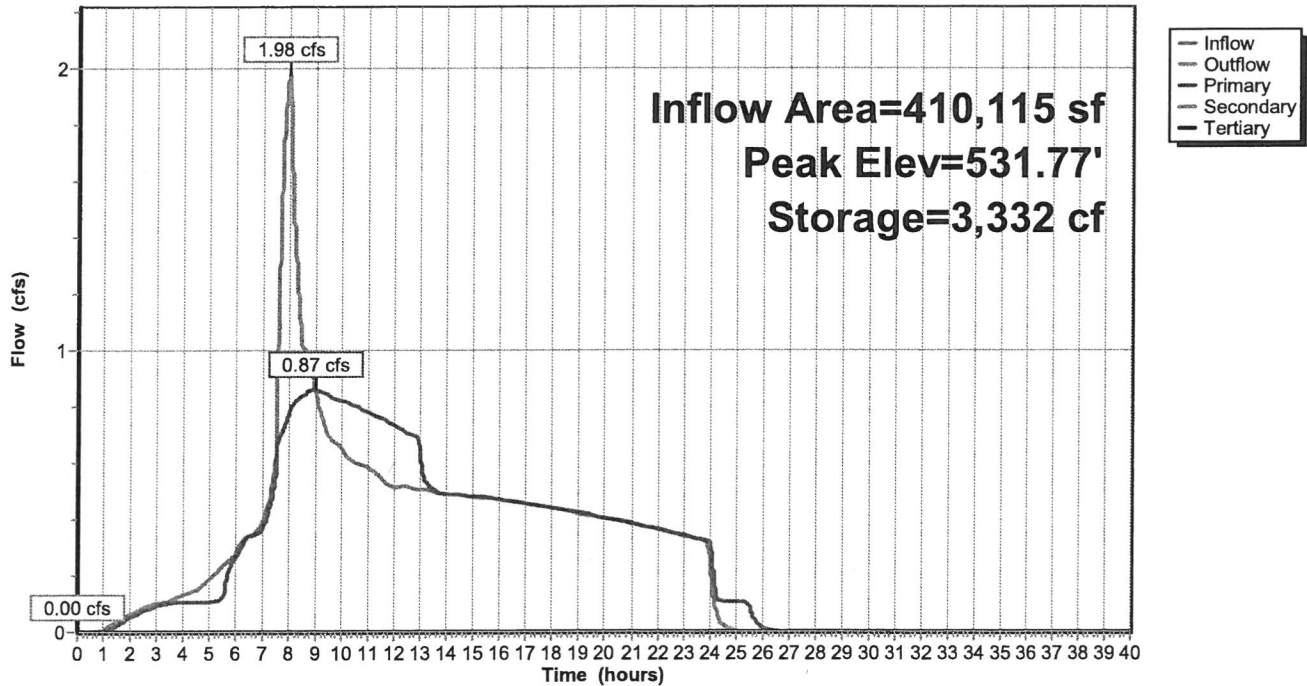

Summary for Link 104L: (new Link)

Inflow Area = 410,115 sf, 4.90% Impervious, Inflow Depth = 0.69" for 2-Year event
Inflow = 0.87 cfs @ 8.01 hrs, Volume= 23,571 cf
Primary = 0.87 cfs @ 8.01 hrs, Volume= 23,571 cf, Atten= 0%, Lag= 0.0 min

Primary outflow = Inflow, Time Span= 0.00-40.00 hrs, dt= 0.01 hrs

Link 104L: (new Link)

Hydrograph

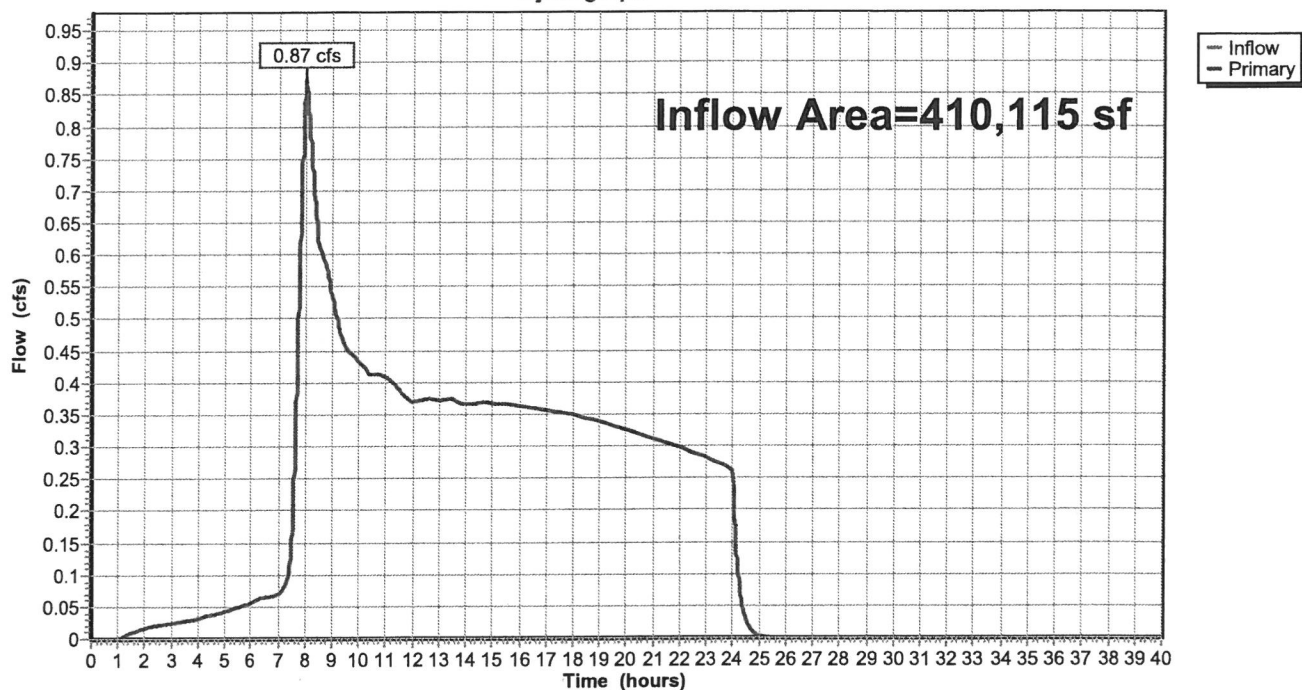

Summary for Subcatchment 100: Pre-Developed Site

Runoff = 0.55 cfs @ 8.00 hrs, Volume= 11,884 cf, Depth= 0.94"

Runoff by SBUH method, Split Pervious/Imperv., Time Span= 0.00-40.00 hrs, dt= 0.01 hrs
Type IA 24-hr 5-Year Rainfall=3.00"

Area (sf)	CN	Description
2,500	98	roofs
149,392	74	>75% Grass cover, Good, HSG C
151,892	74	Weighted Average
149,392	74	98.35% Pervious Area
2,500	98	1.65% Impervious Area

Tc (min)	Length (feet)	Slope (ft/ft)	Velocity (ft/sec)	Capacity (cfs)	Description
5.2	100	0.1350	0.32		Sheet Flow, Grass: Short n= 0.150 P2= 2.50"
4.8	525	0.1350	1.84		Shallow Concentrated Flow, Woodland Kv= 5.0 fps
10.0	625	Total			

Subcatchment 100: Pre-Developed Site

Hydrograph

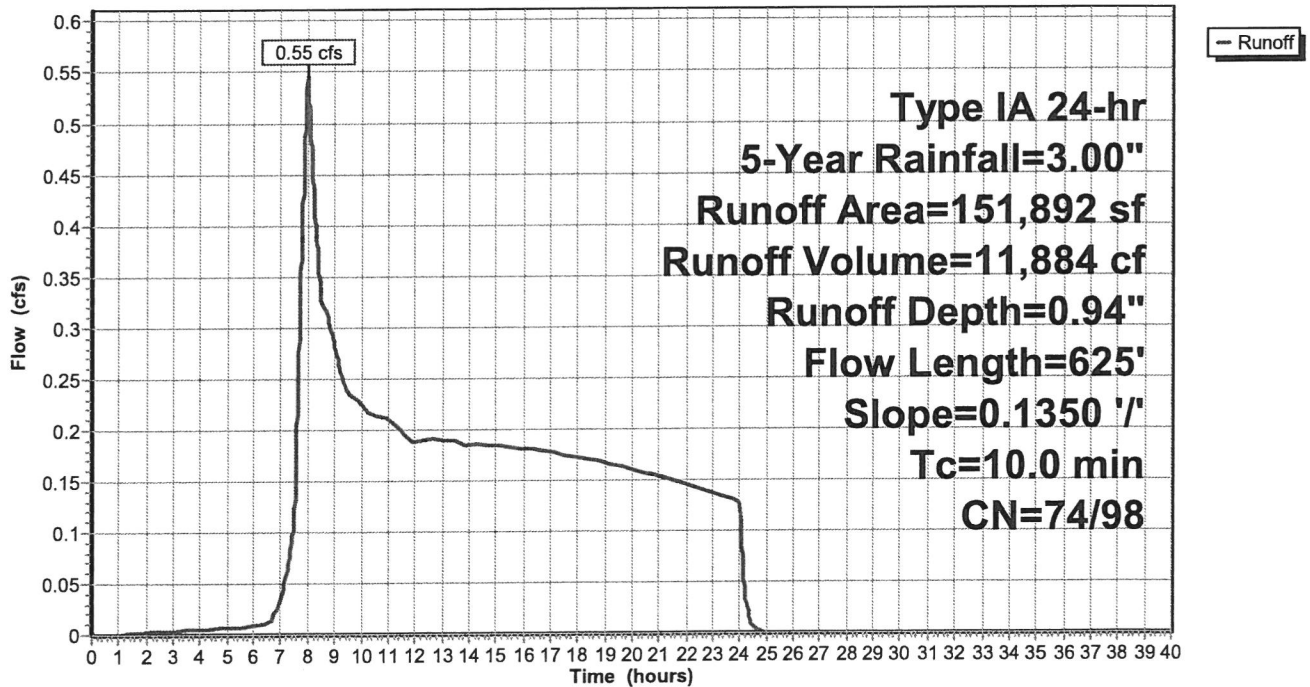

Summary for Subcatchment 101: Post-Developed Site

Runoff = 1.79 cfs @ 7.92 hrs, Volume= 26,433 cf, Depth= 2.09"

Runoff by SBUH method, Split Pervious/Imperv., Time Span= 0.00-40.00 hrs, dt= 0.01 hrs
 Type IA 24-hr 5-Year Rainfall=3.00"

	Area (sf)	CN	Description
*	37,500	98	lots
*	7,602	98	sidewalks
*	13,394	98	ROW
	93,396	86	<50% Grass cover, Poor, HSG C
	151,892	91	Weighted Average
	93,396	86	61.49% Pervious Area
	58,496	98	38.51% Impervious Area

Tc (min)	Length (feet)	Slope (ft/ft)	Velocity (ft/sec)	Capacity (cfs)	Description
5.0					Direct Entry,

Subcatchment 101: Post-Developed Site

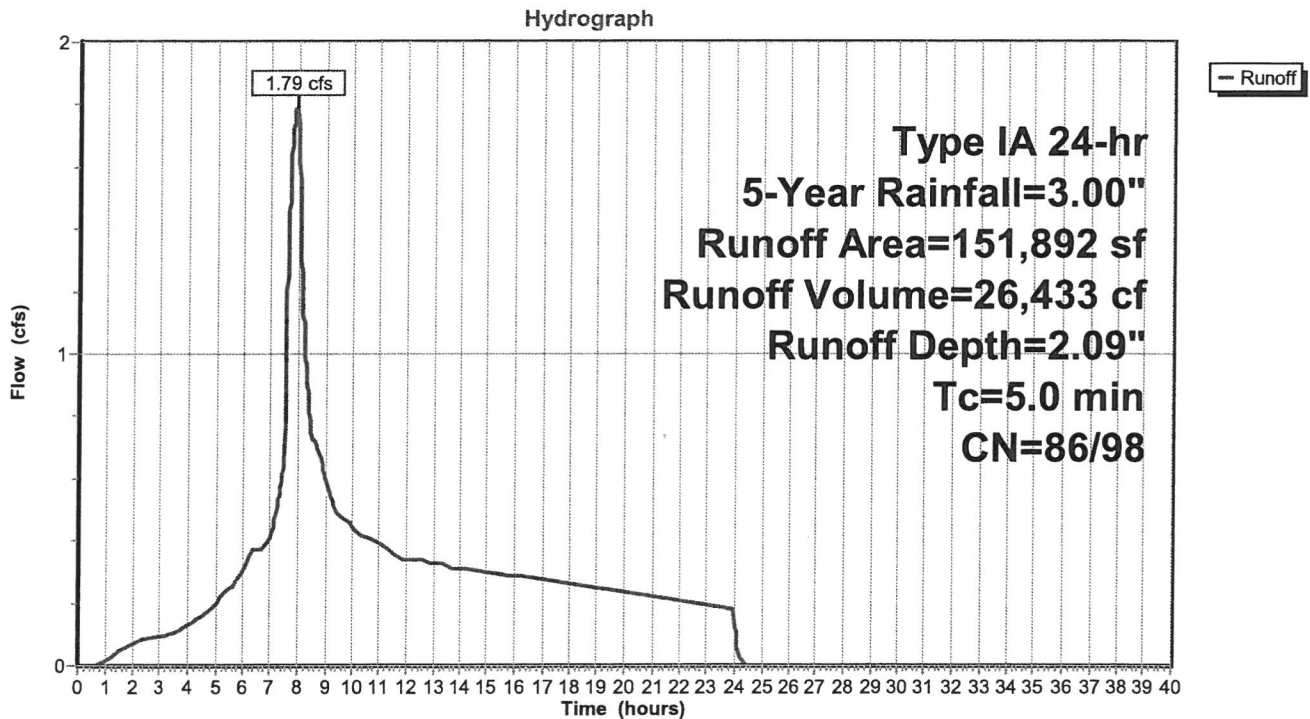

Summary for Subcatchment 200: Upstream Flows

Runoff = 0.98 cfs @ 8.01 hrs, Volume= 22,270 cf, Depth= 1.03"

Runoff by SBUH method, Split Pervious/Imperv., Time Span= 0.00-40.00 hrs, dt= 0.01 hrs
 Type IA 24-hr 5-Year Rainfall=3.00"

	Area (sf)	CN	Description
*	7,500	98	3 lots, impervious area
	240,635	74	>75% Grass cover, Good, HSG C
*	10,088	98	Ex. ROW
<hr/>			
	258,223	76	Weighted Average
	240,635	74	93.19% Pervious Area
	17,588	98	6.81% Impervious Area

Tc (min)	Length (feet)	Slope (ft/ft)	Velocity (ft/sec)	Capacity (cfs)	Description
15.0					Direct Entry,

Subcatchment 200: Upstream Flows

Hydrograph

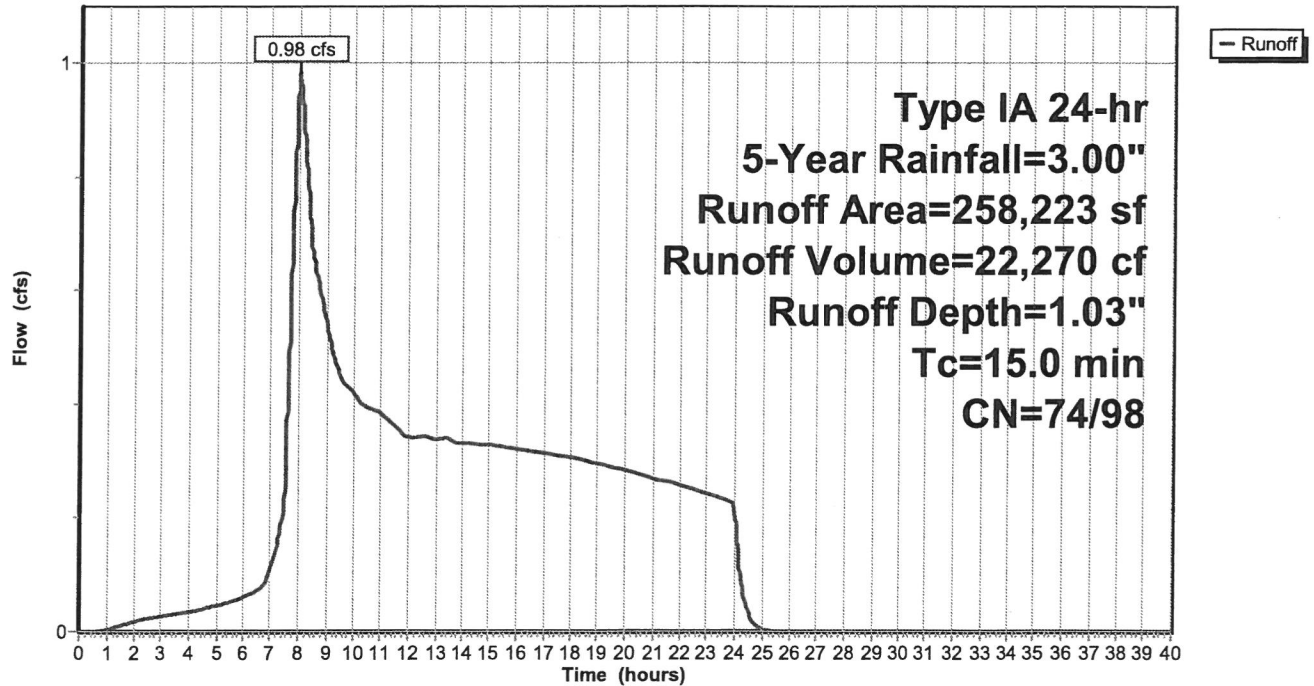

Summary for Subcatchment 201: Upstream Flows

Runoff = 1.02 cfs @ 8.01 hrs, Volume= 22,877 cf, Depth= 1.06"

Runoff by SBUH method, Split Pervious/Imperv., Time Span= 0.00-40.00 hrs, dt= 0.01 hrs
 Type IA 24-hr 5-Year Rainfall=3.00"

Area (sf)	CN	Description
* 7,500	98	3 lots, impervious area
236,718	74	>75% Grass cover, Good, HSG C
* 3,917	98	frontage new ROW
* 10,088	98	Ex. ROW
258,223	76	Weighted Average
236,718	74	91.67% Pervious Area
21,505	98	8.33% Impervious Area

Tc (min)	Length (feet)	Slope (ft/ft)	Velocity (ft/sec)	Capacity (cfs)	Description
15.0					Direct Entry,

Subcatchment 201: Upstream Flows

Hydrograph

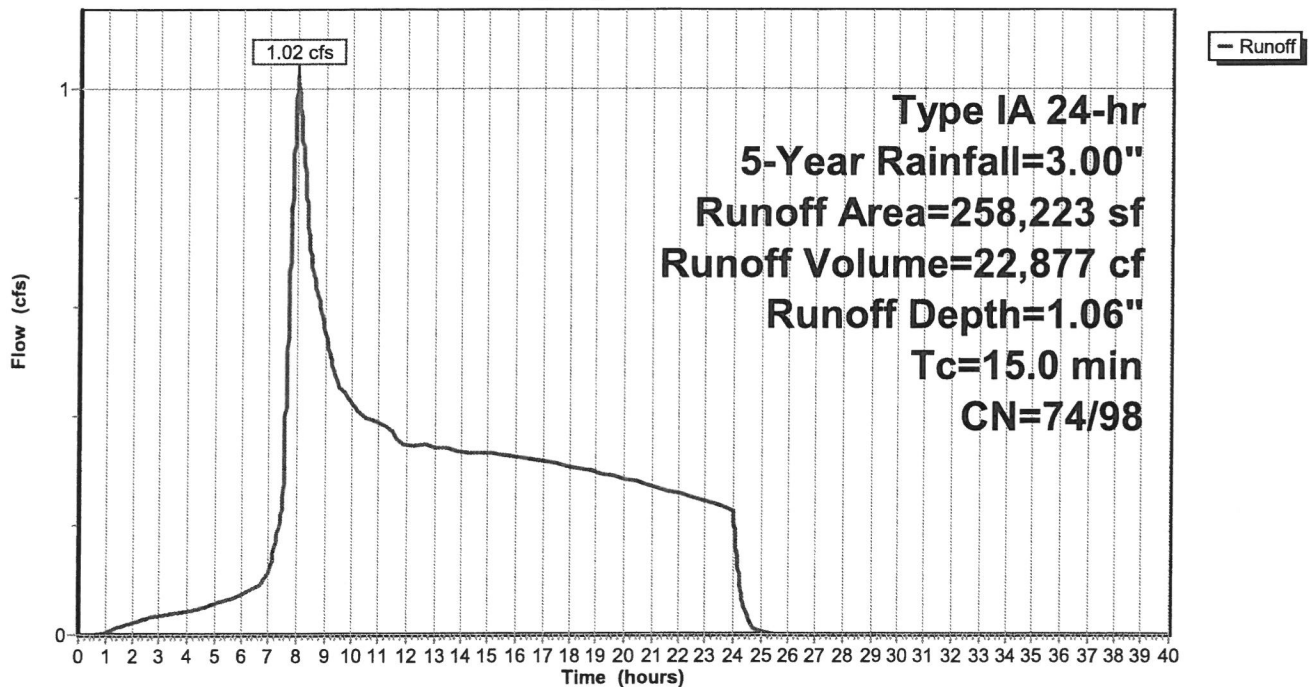

Summary for Pond 1P: Pond

Inflow Area = 410,115 sf, 19.51% Impervious, Inflow Depth = 1.44" for 5-Year event
 Inflow = 2.78 cfs @ 8.00 hrs, Volume= 49,311 cf
 Outflow = 1.51 cfs @ 8.43 hrs, Volume= 49,311 cf, Atten= 46%, Lag= 25.5 min
 Primary = 1.51 cfs @ 8.43 hrs, Volume= 49,311 cf
 Secondary = 0.00 cfs @ 0.00 hrs, Volume= 0 cf
 Tertiary = 0.00 cfs @ 0.00 hrs, Volume= 0 cf

Routing by Stor-Ind method, Time Span= 0.00-40.00 hrs, dt= 0.01 hrs
 Peak Elev= 532.15' @ 8.43 hrs Surf.Area= 3,024 sf Storage= 4,470 cf

Plug-Flow detention time= 39.5 min calculated for 49,311 cf (100% of inflow)
 Center-of-Mass det. time= 39.5 min (816.5 - 777.0)

Volume	Invert	Avail.Storage	Storage Description
#1	530.50'	14,681 cf	Custom Stage Data (Prismatic) Listed below (Recalc)
Elevation (feet)	Surf.Area (sq-ft)	Inc.Store (cubic-feet)	Cum.Store (cubic-feet)
530.50	2,208	0	0
531.00	2,609	1,204	1,204
532.00	3,015	2,812	4,016
533.00	3,075	3,045	7,061
534.00	4,035	3,555	10,616
535.00	4,095	4,065	14,681

Device	Routing	Invert	Outlet Devices
#1	Primary	529.00'	15.0" Round Culvert L= 20.0' RCP, square edge headwall, Ke= 0.500 Inlet / Outlet Invert= 529.00' / 528.90' S= 0.0050 '/' Cc= 0.900 n= 0.013, Flow Area= 1.23 sf
#2	Device 1	527.82'	4.4" Vert. Low Orifice C= 0.600
#3	Device 2	530.50'	2.000 in/hr Exfiltration over Surface area
#4	Device 2	530.72'	24.0" x 24.0" Horiz. Ditch Inlet #1 C= 0.600 Limited to weir flow at low heads
#5	Device 1	531.70'	8.6" Vert. High Orifice C= 0.600
#6	Secondary	532.87'	24.0" x 24.0" Horiz. Ditch Inlet #2 C= 0.600 Limited to weir flow at low heads
#7	Tertiary	532.87'	48.0" Horiz. Overflow Manhole C= 0.600 Limited to weir flow at low heads

Primary OutFlow Max=1.51 cfs @ 8.43 hrs HW=532.15' (Free Discharge)

- 1=Culvert (Passes 1.51 cfs of 9.39 cfs potential flow)
- 2=Low Orifice (Orifice Controls 0.90 cfs @ 8.55 fps)
- 3=Exfiltration (Passes < 0.14 cfs potential flow)
- 4=Ditch Inlet #1 (Passes < 23.03 cfs potential flow)
- 5=High Orifice (Orifice Controls 0.61 cfs @ 2.28 fps)

Secondary OutFlow Max=0.00 cfs @ 0.00 hrs HW=530.50' (Free Discharge)

- 6=Ditch Inlet #2 (Controls 0.00 cfs)

Tertiary OutFlow Max=0.00 cfs @ 0.00 hrs HW=530.50' (Free Discharge)

- 7=Overflow Manhole (Controls 0.00 cfs)

Pond 1P: Pond

Hydrograph

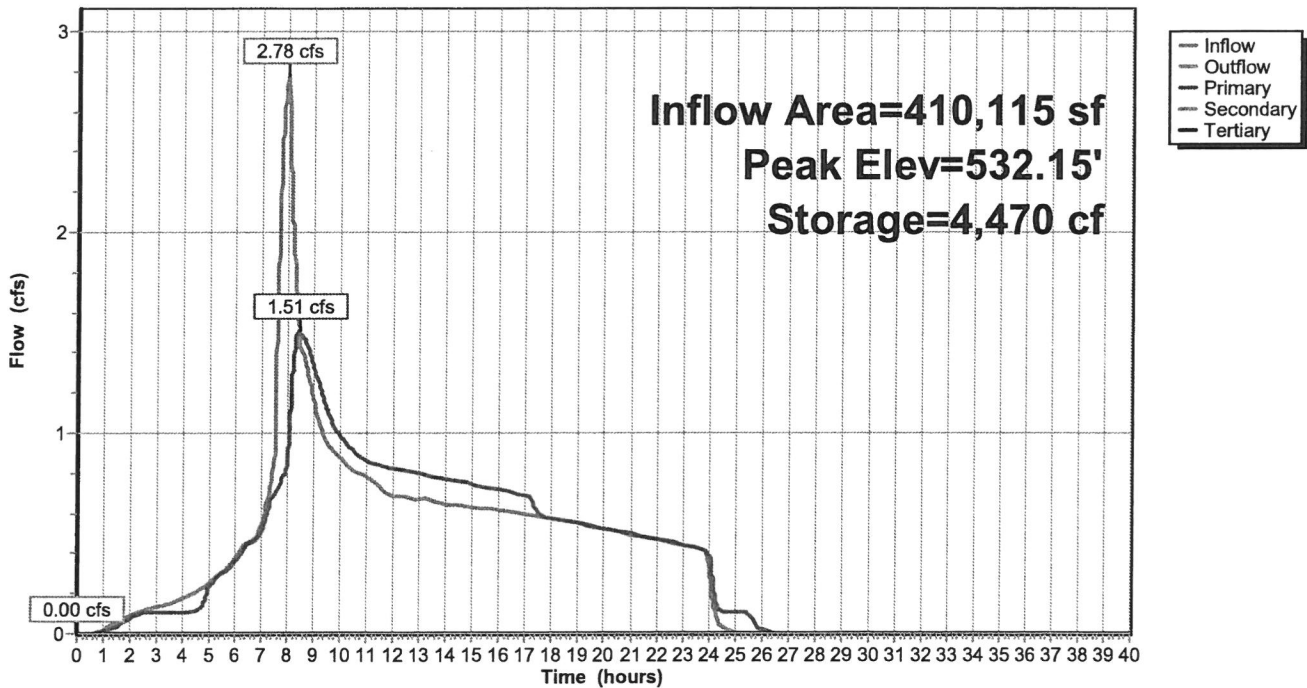

Summary for Link 104L: (new Link)

Inflow Area = 410,115 sf, 4.90% Impervious, Inflow Depth = 1.00" for 5-Year event
Inflow = 1.53 cfs @ 8.01 hrs, Volume= 34,154 cf
Primary = 1.53 cfs @ 8.01 hrs, Volume= 34,154 cf, Atten= 0%, Lag= 0.0 min

Primary outflow = Inflow, Time Span= 0.00-40.00 hrs, dt= 0.01 hrs

Link 104L: (new Link)

Hydrograph

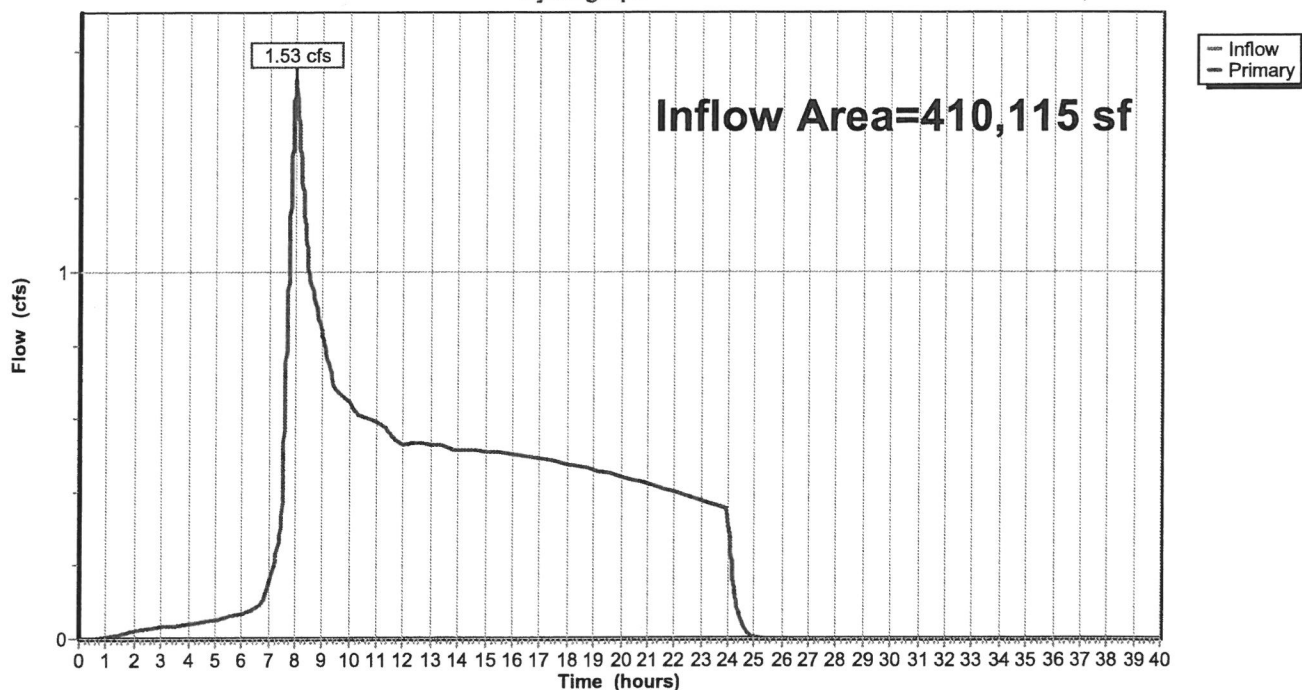

Summary for Subcatchment 100: Pre-Developed Site

Runoff = 0.77 cfs @ 8.00 hrs, Volume= 15,243 cf, Depth= 1.20"

Runoff by SBUH method, Split Pervious/Imperv., Time Span= 0.00-40.00 hrs, dt= 0.01 hrs
 Type IA 24-hr 10-Year Rainfall=3.40"

Area (sf)	CN	Description
2,500	98	roofs
149,392	74	>75% Grass cover, Good, HSG C
151,892	74	Weighted Average
149,392	74	98.35% Pervious Area
2,500	98	1.65% Impervious Area

Tc (min)	Length (feet)	Slope (ft/ft)	Velocity (ft/sec)	Capacity (cfs)	Description
5.2	100	0.1350	0.32		Sheet Flow, Grass: Short n= 0.150 P2= 2.50"
4.8	525	0.1350	1.84		Shallow Concentrated Flow, Woodland Kv= 5.0 fps
10.0	625	Total			

Subcatchment 100: Pre-Developed Site

Hydrograph

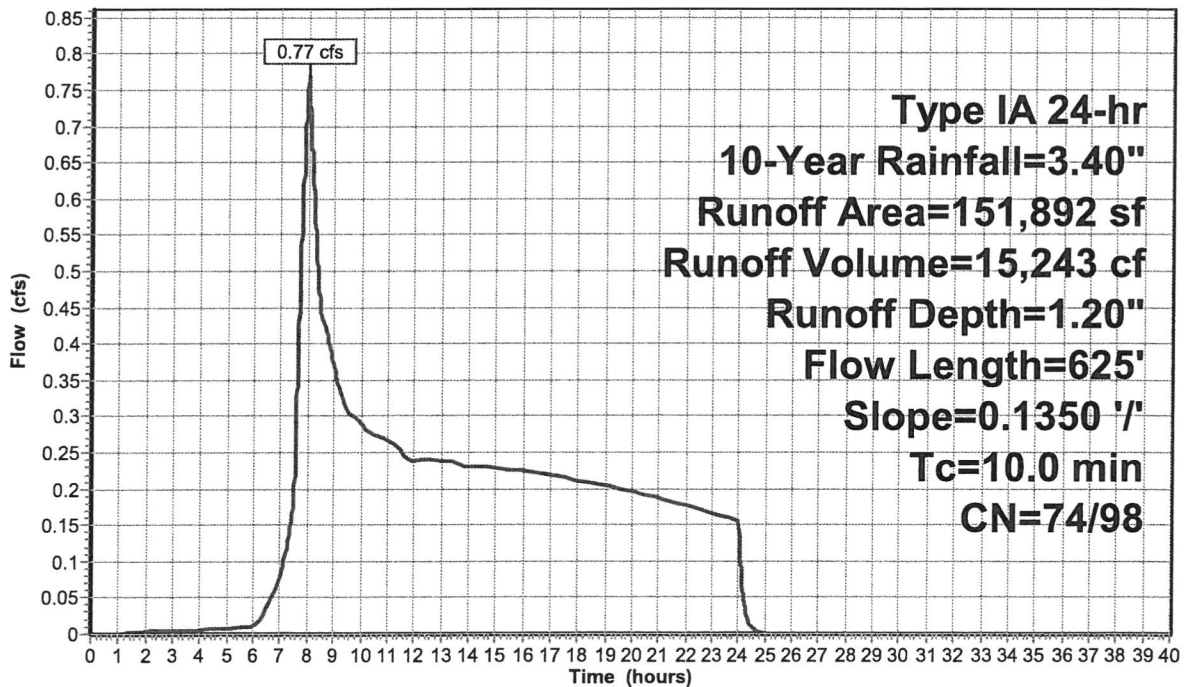

Summary for Subcatchment 101: Post-Developed Site

Runoff = 2.12 cfs @ 7.91 hrs, Volume= 31,081 cf, Depth= 2.46"

Runoff by SBUH method, Split Pervious/Imperv., Time Span= 0.00-40.00 hrs, dt= 0.01 hrs
 Type IA 24-hr 10-Year Rainfall=3.40"

	Area (sf)	CN	Description
*	37,500	98	lots
*	7,602	98	sidewalks
*	13,394	98	ROW
	93,396	86	<50% Grass cover, Poor, HSG C
	151,892	91	Weighted Average
	93,396	86	61.49% Pervious Area
	58,496	98	38.51% Impervious Area

Tc (min)	Length (feet)	Slope (ft/ft)	Velocity (ft/sec)	Capacity (cfs)	Description
5.0					Direct Entry,

Subcatchment 101: Post-Developed Site

Hydrograph

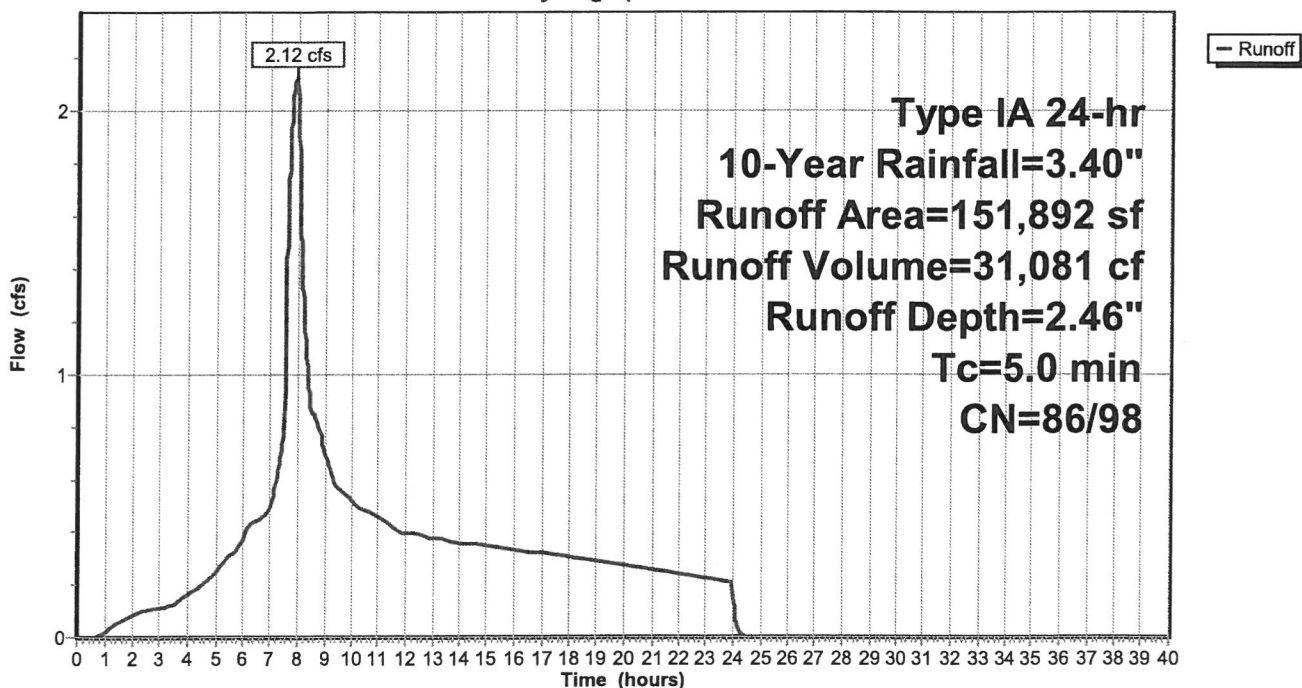

Summary for Subcatchment 200: Upstream Flows

Runoff = 1.34 cfs @ 8.01 hrs, Volume= 28,132 cf, Depth= 1.31"

Runoff by SBUH method, Split Pervious/Imperv., Time Span= 0.00-40.00 hrs, dt= 0.01 hrs
 Type IA 24-hr 10-Year Rainfall=3.40"

	Area (sf)	CN	Description
*	7,500	98	3 lots, impervious area
	240,635	74	>75% Grass cover, Good, HSG C
*	10,088	98	Ex. ROW
	258,223	76	Weighted Average
	240,635	74	93.19% Pervious Area
	17,588	98	6.81% Impervious Area

Tc (min)	Length (feet)	Slope (ft/ft)	Velocity (ft/sec)	Capacity (cfs)	Description
15.0					Direct Entry,

Subcatchment 200: Upstream Flows

Hydrograph

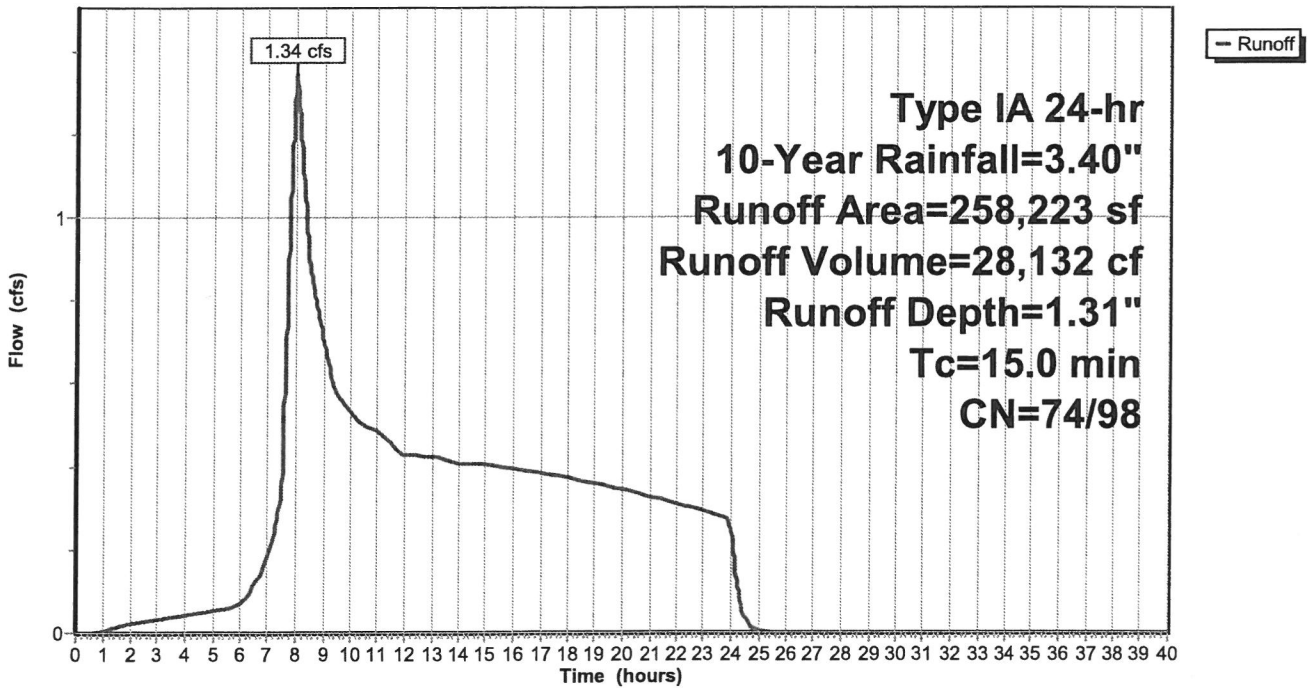

Summary for Subcatchment 201: Upstream Flows

Runoff = 1.39 cfs @ 8.01 hrs, Volume= 28,783 cf, Depth= 1.34"

Runoff by SBUH method, Split Pervious/Imperv., Time Span= 0.00-40.00 hrs, dt= 0.01 hrs
 Type IA 24-hr 10-Year Rainfall=3.40"

	Area (sf)	CN	Description
*	7,500	98	3 lots, impervious area
	236,718	74	>75% Grass cover, Good, HSG C
*	3,917	98	frontage new ROW
*	10,088	98	Ex. ROW
<hr/>			
	258,223	76	Weighted Average
	236,718	74	91.67% Pervious Area
	21,505	98	8.33% Impervious Area

Tc (min)	Length (feet)	Slope (ft/ft)	Velocity (ft/sec)	Capacity (cfs)	Description
15.0					Direct Entry,

Subcatchment 201: Upstream Flows

Hydrograph

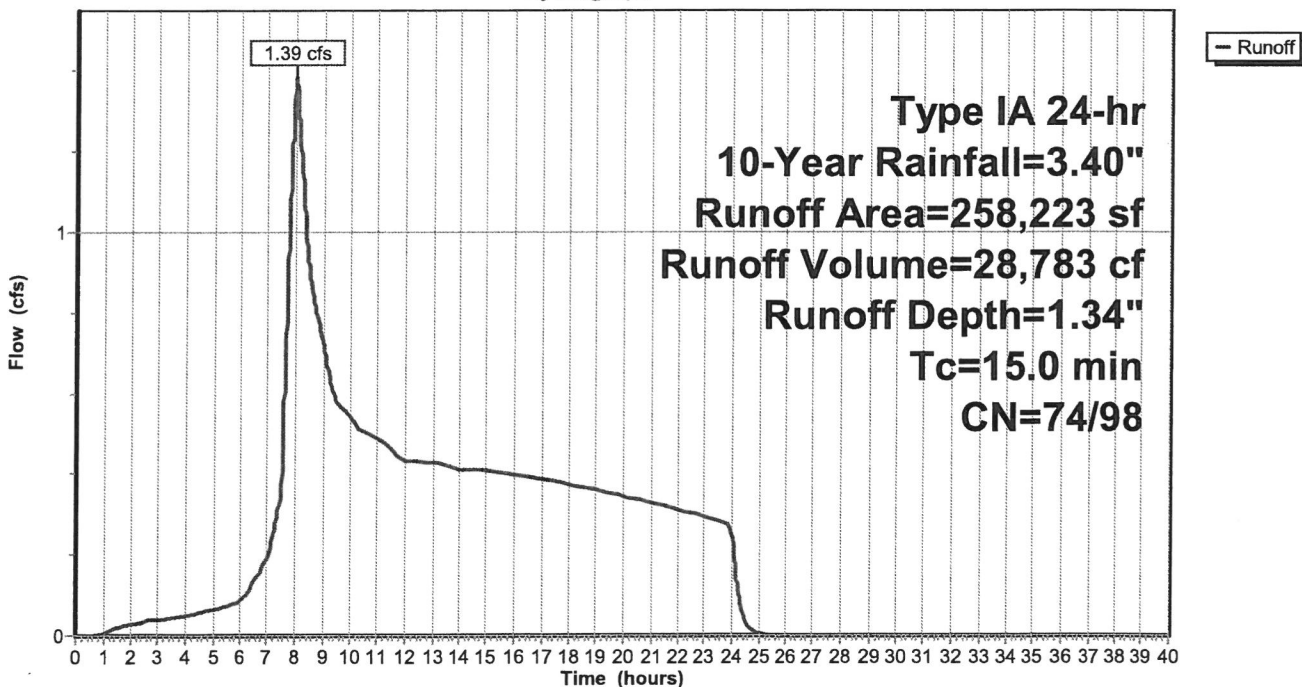

Summary for Pond 1P: Pond

Inflow Area = 410,115 sf, 19.51% Impervious, Inflow Depth = 1.75" for 10-Year event
 Inflow = 3.47 cfs @ 8.00 hrs, Volume= 59,864 cf
 Outflow = 2.11 cfs @ 8.33 hrs, Volume= 59,864 cf, Atten= 39%, Lag= 19.5 min
 Primary = 2.11 cfs @ 8.33 hrs, Volume= 59,864 cf
 Secondary = 0.00 cfs @ 0.00 hrs, Volume= 0 cf
 Tertiary = 0.00 cfs @ 0.00 hrs, Volume= 0 cf

Routing by Stor-Ind method, Time Span= 0.00-40.00 hrs, dt= 0.01 hrs
 Peak Elev= 532.42' @ 8.33 hrs Surf.Area= 3,040 sf Storage= 5,294 cf

Plug-Flow detention time= 44.9 min calculated for 59,850 cf (100% of inflow)
 Center-of-Mass det. time= 45.0 min (815.7 - 770.8)

Volume	Invert	Avail.Storage	Storage Description
#1	530.50'	14,681 cf	Custom Stage Data (Prismatic) Listed below (Recalc)
Elevation (feet)	Surf.Area (sq-ft)	Inc.Store (cubic-feet)	Cum.Store (cubic-feet)
530.50	2,208	0	0
531.00	2,609	1,204	1,204
532.00	3,015	2,812	4,016
533.00	3,075	3,045	7,061
534.00	4,035	3,555	10,616
535.00	4,095	4,065	14,681

Device	Routing	Invert	Outlet Devices
#1	Primary	529.00'	15.0" Round Culvert L= 20.0' RCP, square edge headwall, Ke= 0.500 Inlet / Outlet Invert= 529.00' / 528.90' S= 0.0050 '/ Cc= 0.900 n= 0.013, Flow Area= 1.23 sf
#2	Device 1	527.82'	4.4" Vert. Low Orifice C= 0.600
#3	Device 2	530.50'	2.000 in/hr Exfiltration over Surface area
#4	Device 2	530.72'	24.0" x 24.0" Horiz. Ditch Inlet #1 C= 0.600 Limited to weir flow at low heads
#5	Device 1	531.70'	8.6" Vert. High Orifice C= 0.600
#6	Secondary	532.87'	24.0" x 24.0" Horiz. Ditch Inlet #2 C= 0.600 Limited to weir flow at low heads
#7	Tertiary	532.87'	48.0" Horiz. Overflow Manhole C= 0.600 Limited to weir flow at low heads

Primary OutFlow Max=2.11 cfs @ 8.33 hrs HW=532.42' (Free Discharge)

- 1=Culvert (Passes 2.11 cfs of 9.88 cfs potential flow)
- 2=Low Orifice (Orifice Controls 0.94 cfs @ 8.91 fps)
- 3=Exfiltration (Passes < 0.14 cfs potential flow)
- 4=Ditch Inlet #1 (Passes < 25.13 cfs potential flow)
- 5=High Orifice (Orifice Controls 1.17 cfs @ 2.90 fps)

Secondary OutFlow Max=0.00 cfs @ 0.00 hrs HW=530.50' (Free Discharge)

- 6=Ditch Inlet #2 (Controls 0.00 cfs)

Tertiary OutFlow Max=0.00 cfs @ 0.00 hrs HW=530.50' (Free Discharge)

- 7=Overflow Manhole (Controls 0.00 cfs)

Pond 1P: Pond

Hydrograph

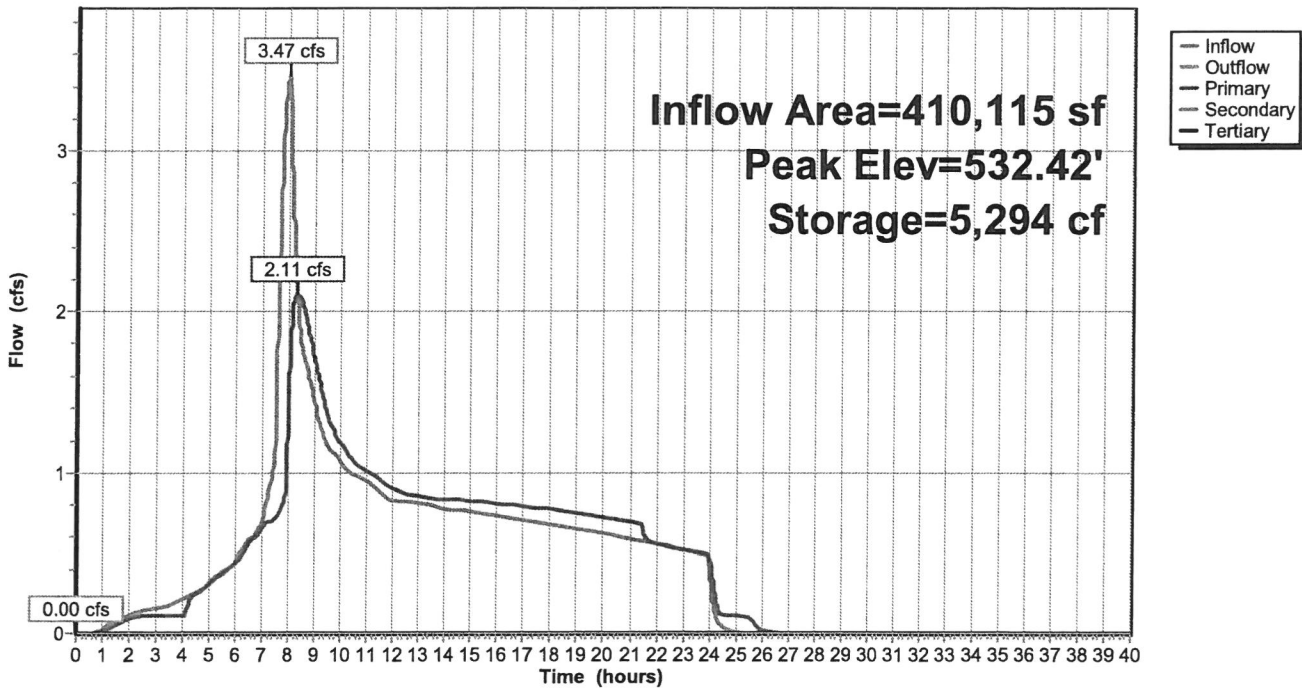

Summary for Link 104L: (new Link)

Inflow Area = 410,115 sf, 4.90% Impervious, Inflow Depth = 1.27" for 10-Year event
Inflow = 2.11 cfs @ 8.00 hrs, Volume= 43,375 cf
Primary = 2.11 cfs @ 8.00 hrs, Volume= 43,375 cf, Atten= 0%, Lag= 0.0 min

Primary outflow = Inflow, Time Span= 0.00-40.00 hrs, dt= 0.01 hrs

Link 104L: (new Link)

Hydrograph

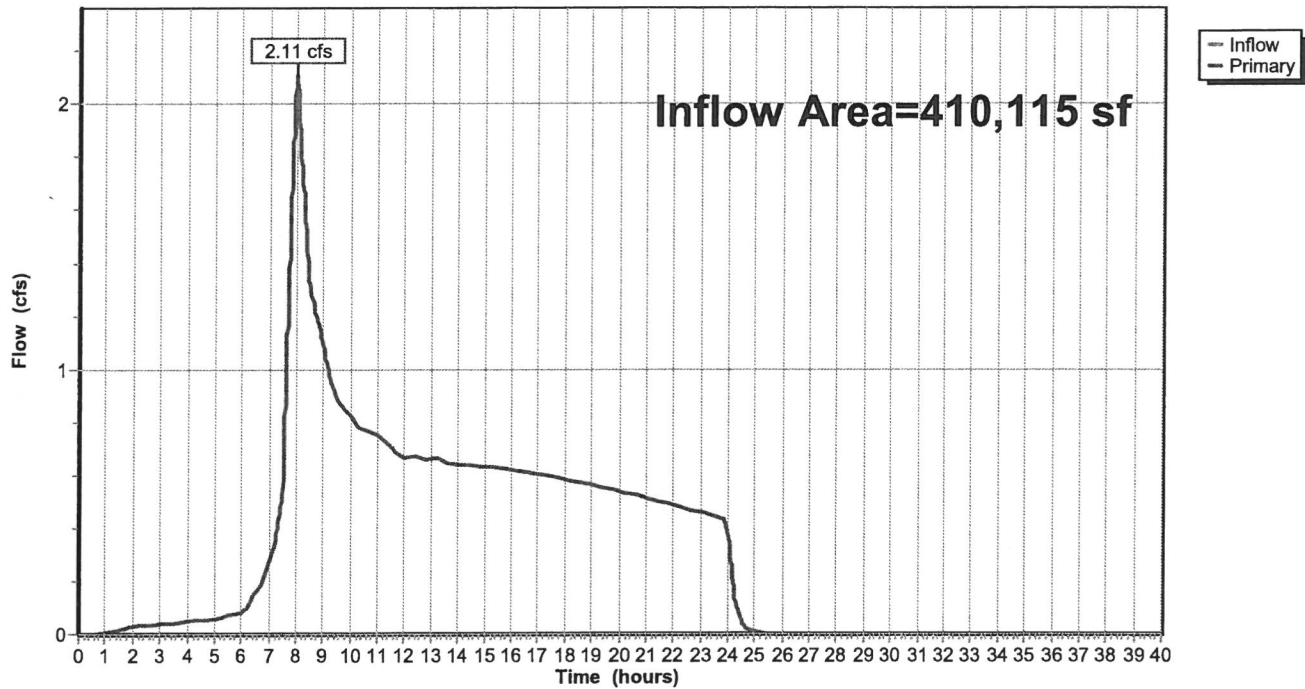

Summary for Subcatchment 100: Pre-Developed Site

Runoff = 1.07 cfs @ 8.00 hrs, Volume= 19,728 cf, Depth= 1.56"

Runoff by SBUH method, Split Pervious/Imperv., Time Span= 0.00-40.00 hrs, dt= 0.01 hrs
 Type IA 24-hr 25-Year Rainfall=3.90"

Area (sf)	CN	Description
2,500	98	roofs
149,392	74	>75% Grass cover, Good, HSG C
151,892	74	Weighted Average
149,392	74	98.35% Pervious Area
2,500	98	1.65% Impervious Area

Tc (min)	Length (feet)	Slope (ft/ft)	Velocity (ft/sec)	Capacity (cfs)	Description
5.2	100	0.1350	0.32		Sheet Flow, Grass: Short n= 0.150 P2= 2.50"
4.8	525	0.1350	1.84		Shallow Concentrated Flow, Woodland Kv= 5.0 fps
10.0	625	Total			

Subcatchment 100: Pre-Developed Site

Hydrograph

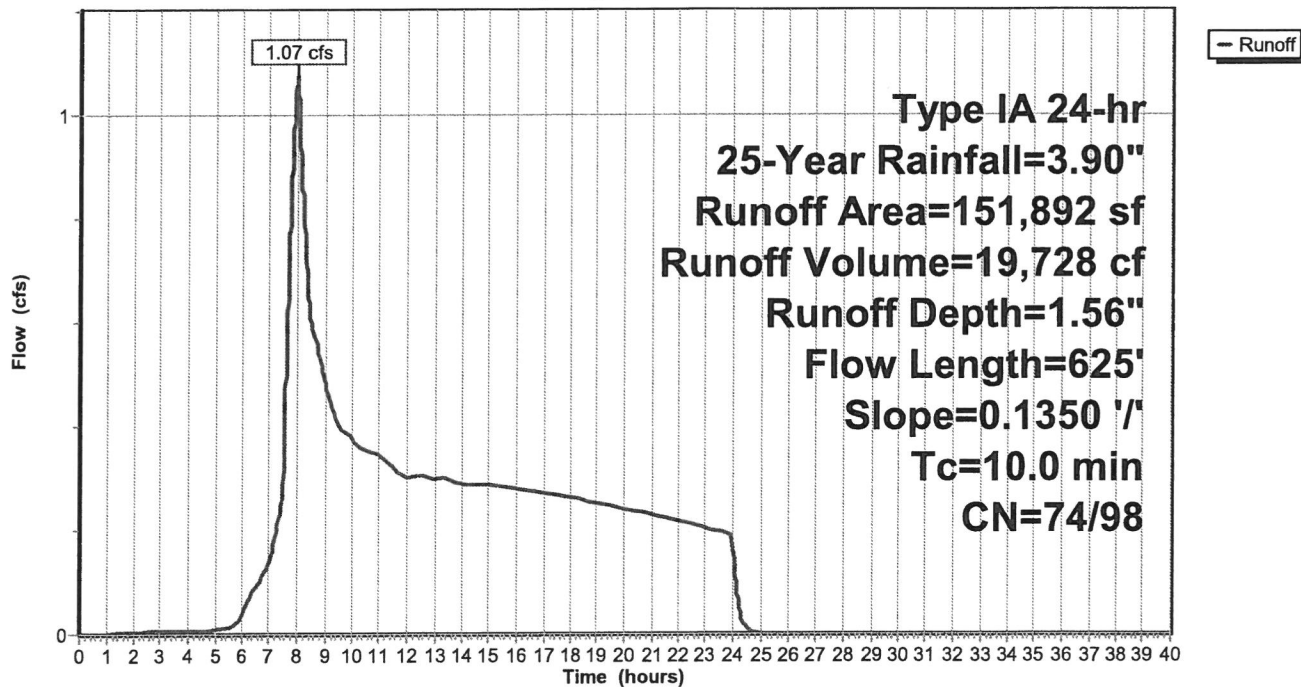

Summary for Subcatchment 101: Post-Developed Site

Runoff = 2.54 cfs @ 7.91 hrs, Volume= 36,982 cf, Depth= 2.92"

Runoff by SBUH method, Split Pervious/Imperv., Time Span= 0.00-40.00 hrs, dt= 0.01 hrs
Type IA 24-hr 25-Year Rainfall=3.90"

	Area (sf)	CN	Description
*	37,500	98	lots
*	7,602	98	sidewalks
*	13,394	98	ROW
	93,396	86	<50% Grass cover, Poor, HSG C
	151,892	91	Weighted Average
	93,396	86	61.49% Pervious Area
	58,496	98	38.51% Impervious Area

Tc (min)	Length (feet)	Slope (ft/ft)	Velocity (ft/sec)	Capacity (cfs)	Description
5.0					Direct Entry,

Subcatchment 101: Post-Developed Site

Hydrograph

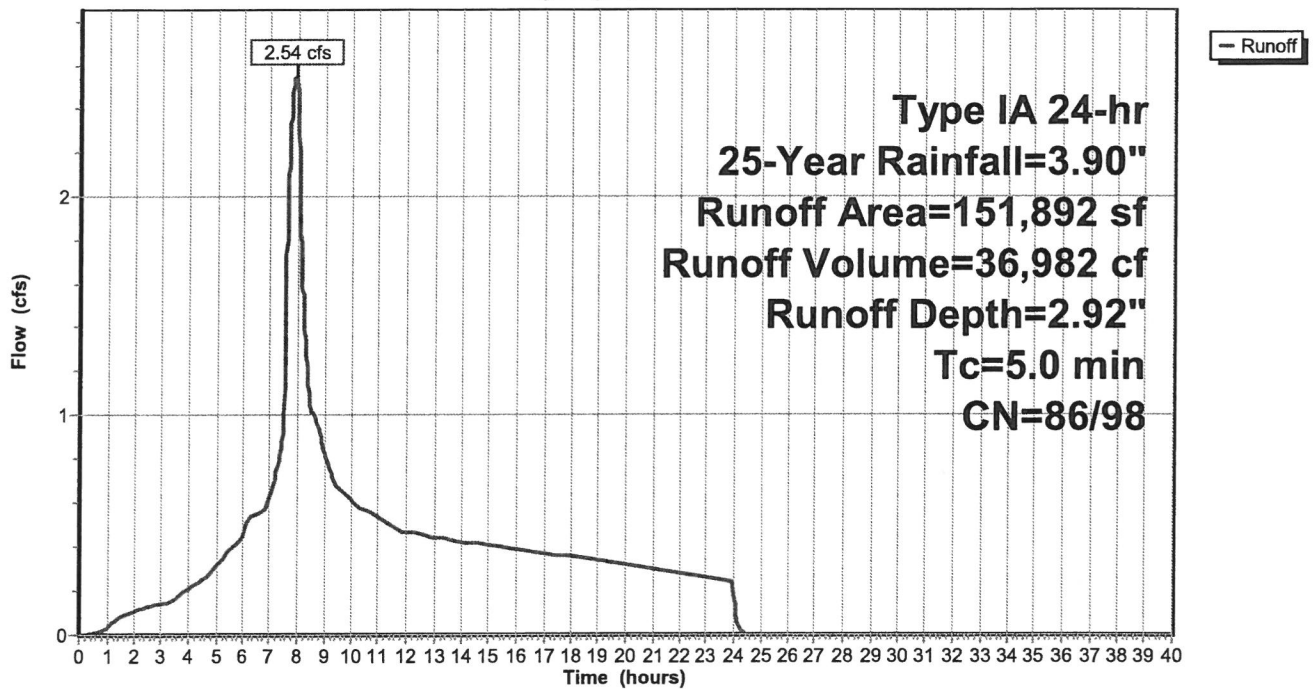

Summary for Subcatchment 200: Upstream Flows

Runoff = 1.83 cfs @ 8.00 hrs, Volume= 35,919 cf, Depth= 1.67"

Runoff by SBUH method, Split Pervious/Imperv., Time Span= 0.00-40.00 hrs, dt= 0.01 hrs
Type IA 24-hr 25-Year Rainfall=3.90"

Area (sf)	CN	Description
* 7,500	98	3 lots, impervious area
240,635	74	>75% Grass cover, Good, HSG C
* 10,088	98	Ex. ROW
258,223	76	Weighted Average
240,635	74	93.19% Pervious Area
17,588	98	6.81% Impervious Area

Tc (min)	Length (feet)	Slope (ft/ft)	Velocity (ft/sec)	Capacity (cfs)	Description
15.0					Direct Entry,

Subcatchment 200: Upstream Flows

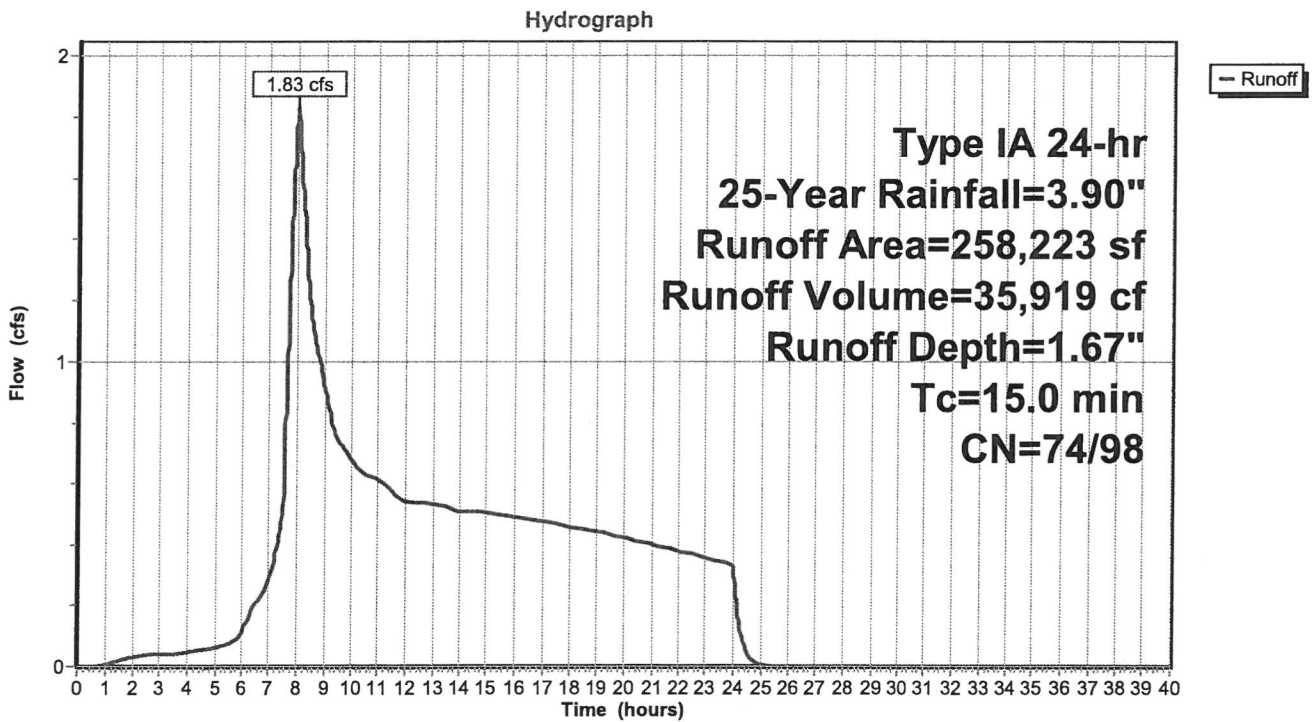

Summary for Subcatchment 201: Upstream Flows

Runoff = 1.88 cfs @ 8.00 hrs, Volume= 36,618 cf, Depth= 1.70"

Runoff by SBUH method, Split Pervious/Imperv., Time Span= 0.00-40.00 hrs, dt= 0.01 hrs
 Type IA 24-hr 25-Year Rainfall=3.90"

	Area (sf)	CN	Description
*	7,500	98	3 lots, impervious area
	236,718	74	>75% Grass cover, Good, HSG C
*	3,917	98	frontage new ROW
*	10,088	98	Ex. ROW
<hr/>			
	258,223	76	Weighted Average
	236,718	74	91.67% Pervious Area
	21,505	98	8.33% Impervious Area

Tc (min)	Length (feet)	Slope (ft/ft)	Velocity (ft/sec)	Capacity (cfs)	Description
15.0					Direct Entry,

Subcatchment 201: Upstream Flows

Hydrograph

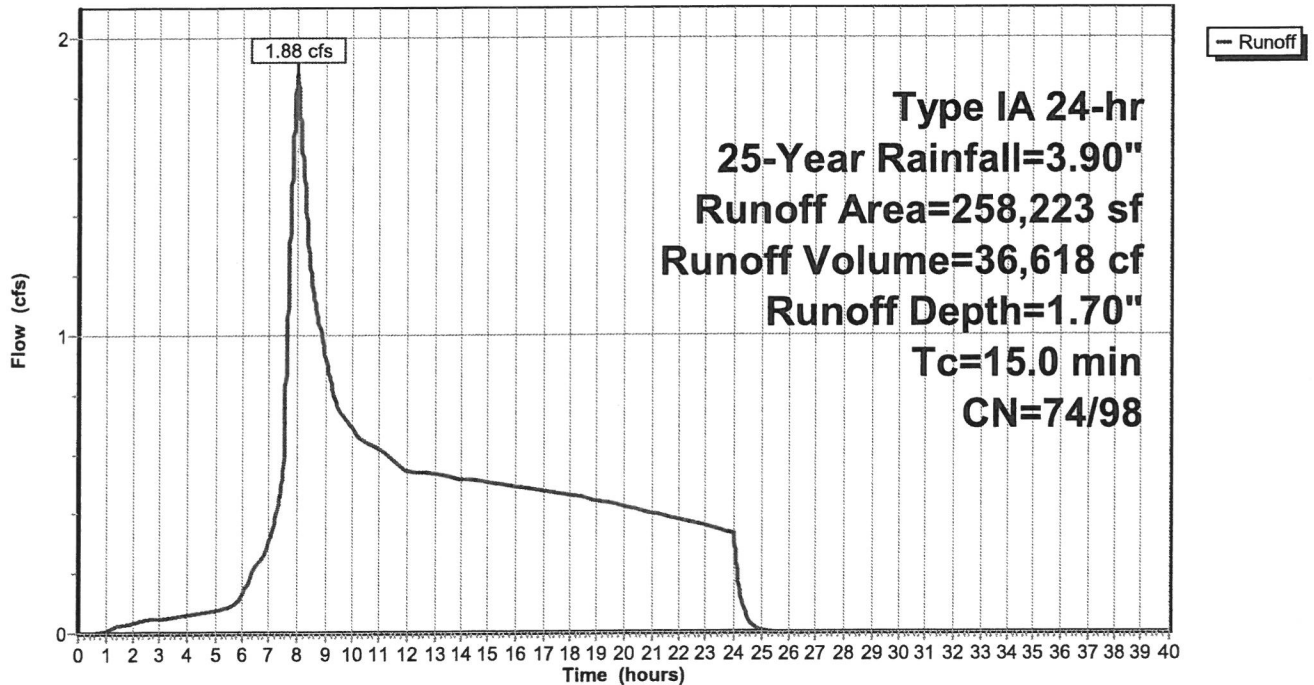

Summary for Pond 1P: Pond

Inflow Area = 410,115 sf, 19.51% Impervious, Inflow Depth = 2.15" for 25-Year event
 Inflow = 4.36 cfs @ 8.00 hrs, Volume= 73,600 cf
 Outflow = 2.74 cfs @ 8.30 hrs, Volume= 73,600 cf, Atten= 37%, Lag= 18.1 min
 Primary = 2.74 cfs @ 8.30 hrs, Volume= 73,600 cf
 Secondary = 0.00 cfs @ 0.00 hrs, Volume= 0 cf
 Tertiary = 0.00 cfs @ 0.00 hrs, Volume= 0 cf

Routing by Stor-Ind method, Time Span= 0.00-40.00 hrs, dt= 0.01 hrs
 Peak Elev= 532.86' @ 8.30 hrs Surf.Area= 3,067 sf Storage= 6,636 cf

Plug-Flow detention time= 50.0 min calculated for 73,582 cf (100% of inflow)
 Center-of-Mass det. time= 50.0 min (813.8 - 763.8)

Volume	Invert	Avail.Storage	Storage Description
#1	530.50'	14,681 cf	Custom Stage Data (Prismatic) Listed below (Recalc)
Elevation (feet)	Surf.Area (sq-ft)	Inc.Store (cubic-feet)	Cum.Store (cubic-feet)
530.50	2,208	0	0
531.00	2,609	1,204	1,204
532.00	3,015	2,812	4,016
533.00	3,075	3,045	7,061
534.00	4,035	3,555	10,616
535.00	4,095	4,065	14,681

Device	Routing	Invert	Outlet Devices
#1	Primary	529.00'	15.0" Round Culvert L= 20.0' RCP, square edge headwall, Ke= 0.500 Inlet / Outlet Invert= 529.00' / 528.90' S= 0.0050 ' / ' Cc= 0.900 n= 0.013, Flow Area= 1.23 sf
#2	Device 1	527.82'	4.4" Vert. Low Orifice C= 0.600
#3	Device 2	530.50'	2.000 in/hr Exfiltration over Surface area
#4	Device 2	530.72'	24.0" x 24.0" Horiz. Ditch Inlet #1 C= 0.600 Limited to weir flow at low heads
#5	Device 1	531.70'	8.6" Vert. High Orifice C= 0.600
#6	Secondary	532.87'	24.0" x 24.0" Horiz. Ditch Inlet #2 C= 0.600 Limited to weir flow at low heads
#7	Tertiary	532.87'	48.0" Horiz. Overflow Manhole C= 0.600 Limited to weir flow at low heads

Primary OutFlow Max=2.74 cfs @ 8.30 hrs HW=532.86' (Free Discharge)

- 1=Culvert (Passes 2.74 cfs of 10.63 cfs potential flow)
- 2=Low Orifice (Orifice Controls 1.00 cfs @ 9.46 fps)
- 3=Exfiltration (Passes < 0.14 cfs potential flow)
- 4=Ditch Inlet #1 (Passes < 28.18 cfs potential flow)
- 5=High Orifice (Orifice Controls 1.74 cfs @ 4.32 fps)

Secondary OutFlow Max=0.00 cfs @ 0.00 hrs HW=530.50' (Free Discharge)

- 6=Ditch Inlet #2 (Controls 0.00 cfs)

Tertiary OutFlow Max=0.00 cfs @ 0.00 hrs HW=530.50' (Free Discharge)

- 7=Overflow Manhole (Controls 0.00 cfs)

Pond 1P: Pond

Hydrograph

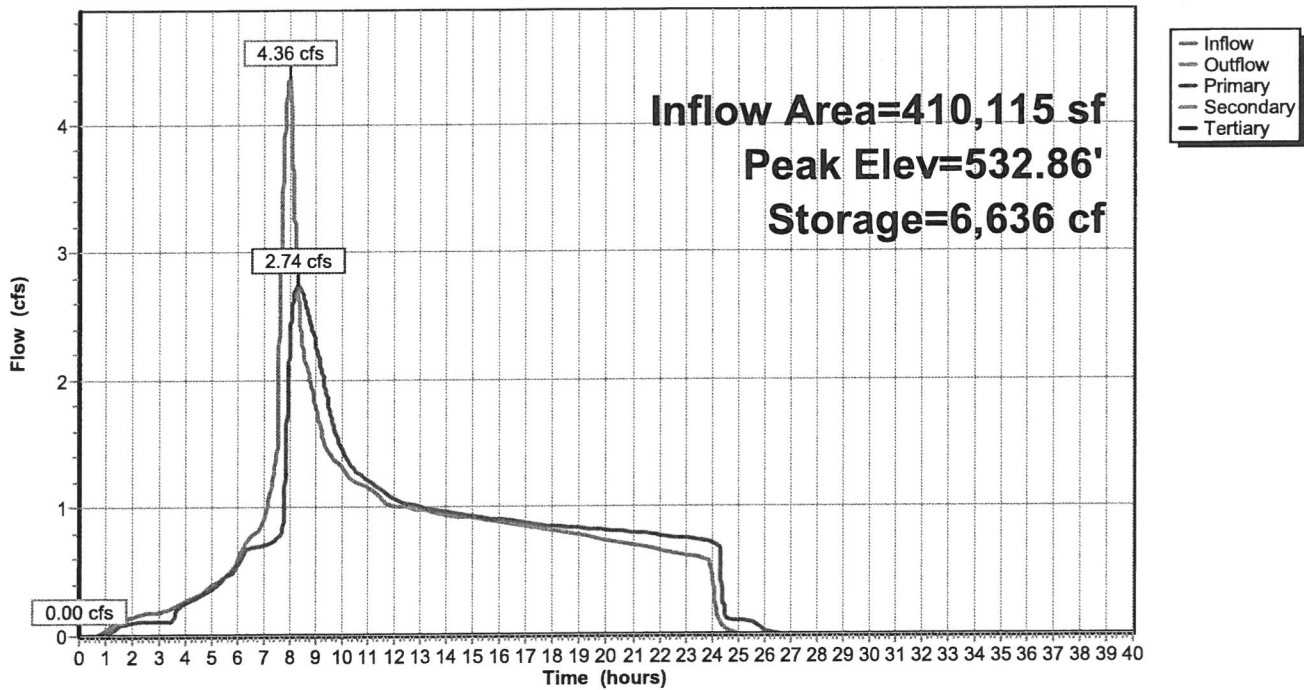

Summary for Link 104L: (new Link)

Inflow Area = 410,115 sf, 4.90% Impervious, Inflow Depth = 1.63" for 25-Year event
Inflow = 2.90 cfs @ 8.00 hrs, Volume= 55,647 cf
Primary = 2.90 cfs @ 8.00 hrs, Volume= 55,647 cf, Atten= 0%, Lag= 0.0 min

Primary outflow = Inflow, Time Span= 0.00-40.00 hrs, dt= 0.01 hrs

Link 104L: (new Link)

Hydrograph

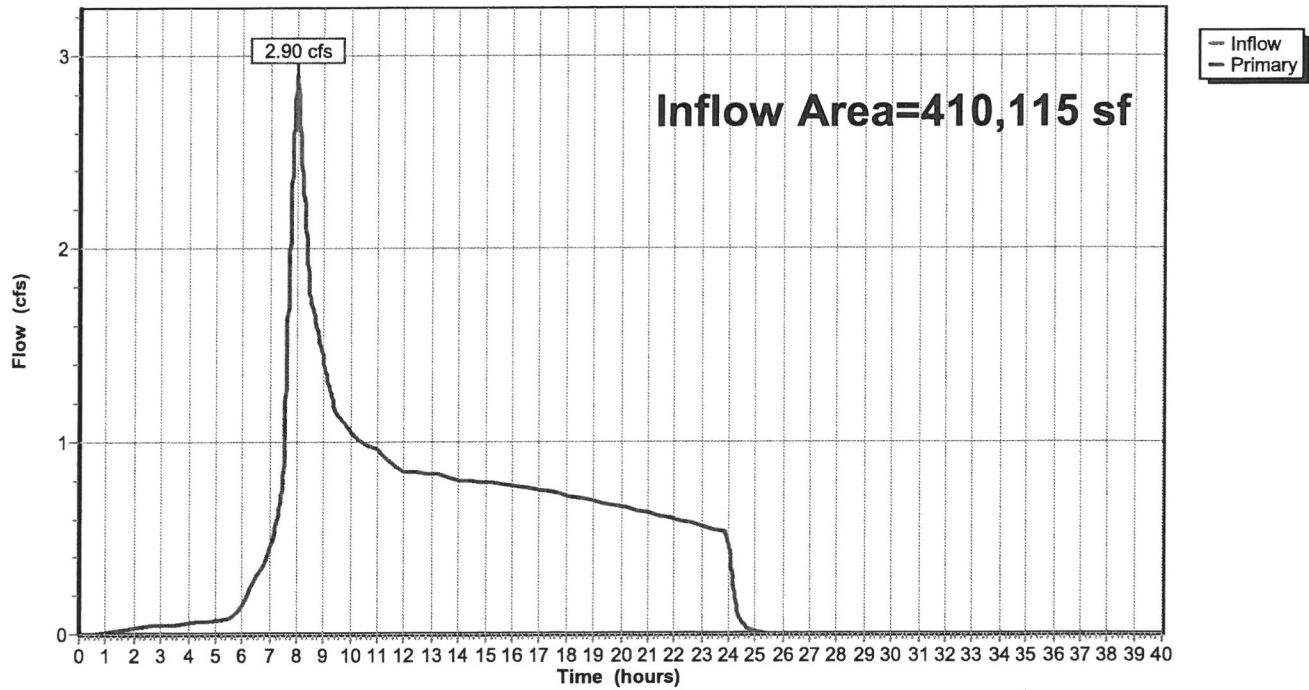

Summary for Subcatchment 100: Pre-Developed Site

Runoff = 1.47 cfs @ 8.00 hrs, Volume= 25,443 cf, Depth= 2.01"

Runoff by SBUH method, Split Pervious/Imperv., Time Span= 0.00-40.00 hrs, dt= 0.01 hrs
 Type IA 24-hr 100-Year Rainfall=4.50"

Area (sf)	CN	Description
2,500	98	roofs
149,392	74	>75% Grass cover, Good, HSG C
151,892	74	Weighted Average
149,392	74	98.35% Pervious Area
2,500	98	1.65% Impervious Area

Tc (min)	Length (feet)	Slope (ft/ft)	Velocity (ft/sec)	Capacity (cfs)	Description
5.2	100	0.1350	0.32		Sheet Flow, Grass: Short n= 0.150 P2= 2.50"
4.8	525	0.1350	1.84		Shallow Concentrated Flow, Woodland Kv= 5.0 fps
10.0	625	Total			

Subcatchment 100: Pre-Developed Site

Hydrograph

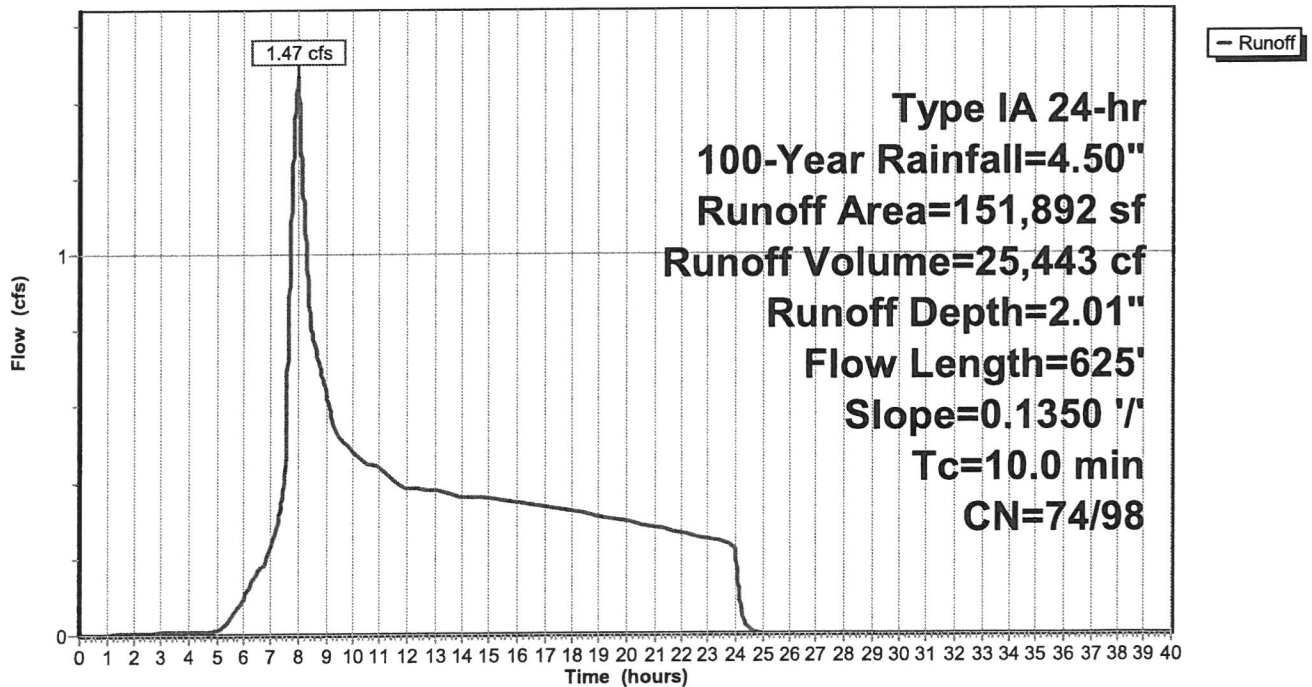

Summary for Subcatchment 101: Post-Developed Site

Runoff = 3.05 cfs @ 7.90 hrs, Volume= 44,160 cf, Depth= 3.49"

Runoff by SBUH method, Split Pervious/Imperv., Time Span= 0.00-40.00 hrs, dt= 0.01 hrs
 Type IA 24-hr 100-Year Rainfall=4.50"

	Area (sf)	CN	Description
*	37,500	98	lots
*	7,602	98	sidewalks
*	13,394	98	ROW
	93,396	86	<50% Grass cover, Poor, HSG C
	151,892	91	Weighted Average
	93,396	86	61.49% Pervious Area
	58,496	98	38.51% Impervious Area

Tc (min)	Length (feet)	Slope (ft/ft)	Velocity (ft/sec)	Capacity (cfs)	Description
5.0					Direct Entry,

Subcatchment 101: Post-Developed Site

Hydrograph

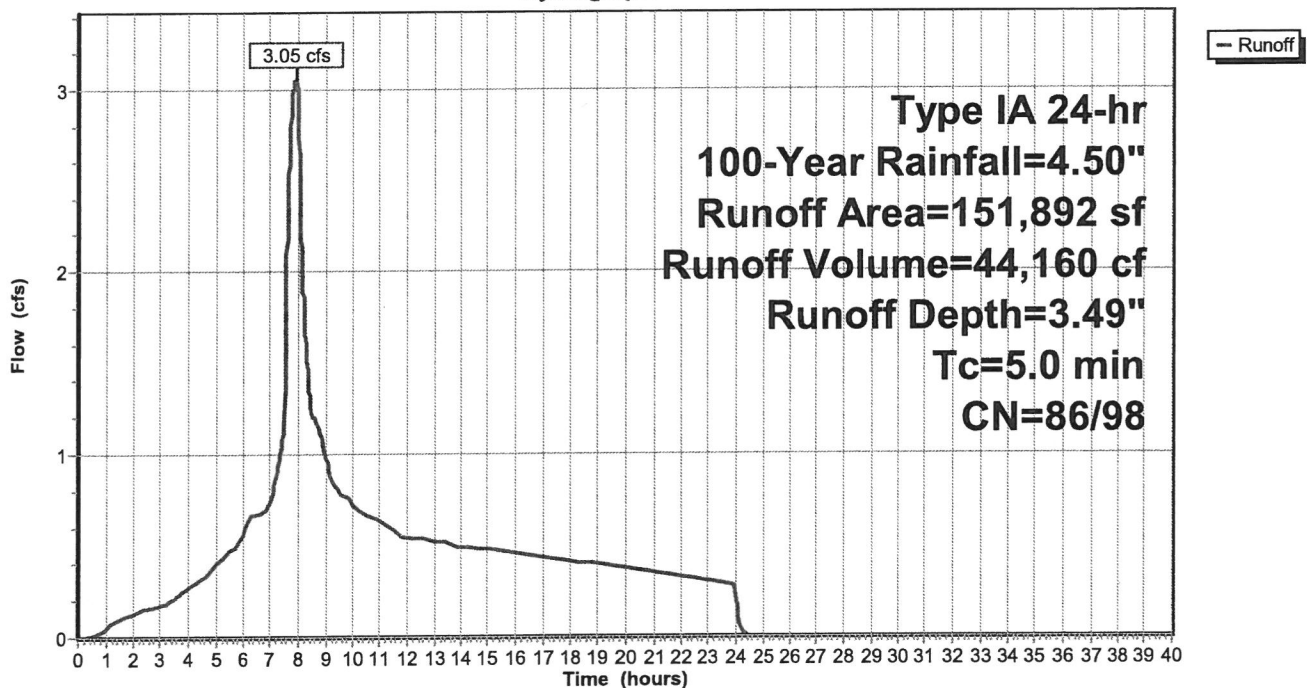

Summary for Subcatchment 200: Upstream Flows

Runoff = 2.46 cfs @ 8.00 hrs, Volume= 45,801 cf, Depth= 2.13"

Runoff by SBUH method, Split Pervious/Imperv., Time Span= 0.00-40.00 hrs, dt= 0.01 hrs
 Type IA 24-hr 100-Year Rainfall=4.50"

	Area (sf)	CN	Description
*	7,500	98	3 lots, impervious area
	240,635	74	>75% Grass cover, Good, HSG C
*	10,088	98	Ex. ROW
<hr/>			
	258,223	76	Weighted Average
	240,635	74	93.19% Pervious Area
	17,588	98	6.81% Impervious Area

Tc (min)	Length (feet)	Slope (ft/ft)	Velocity (ft/sec)	Capacity (cfs)	Description
15.0					Direct Entry,

Subcatchment 200: Upstream Flows

Hydrograph

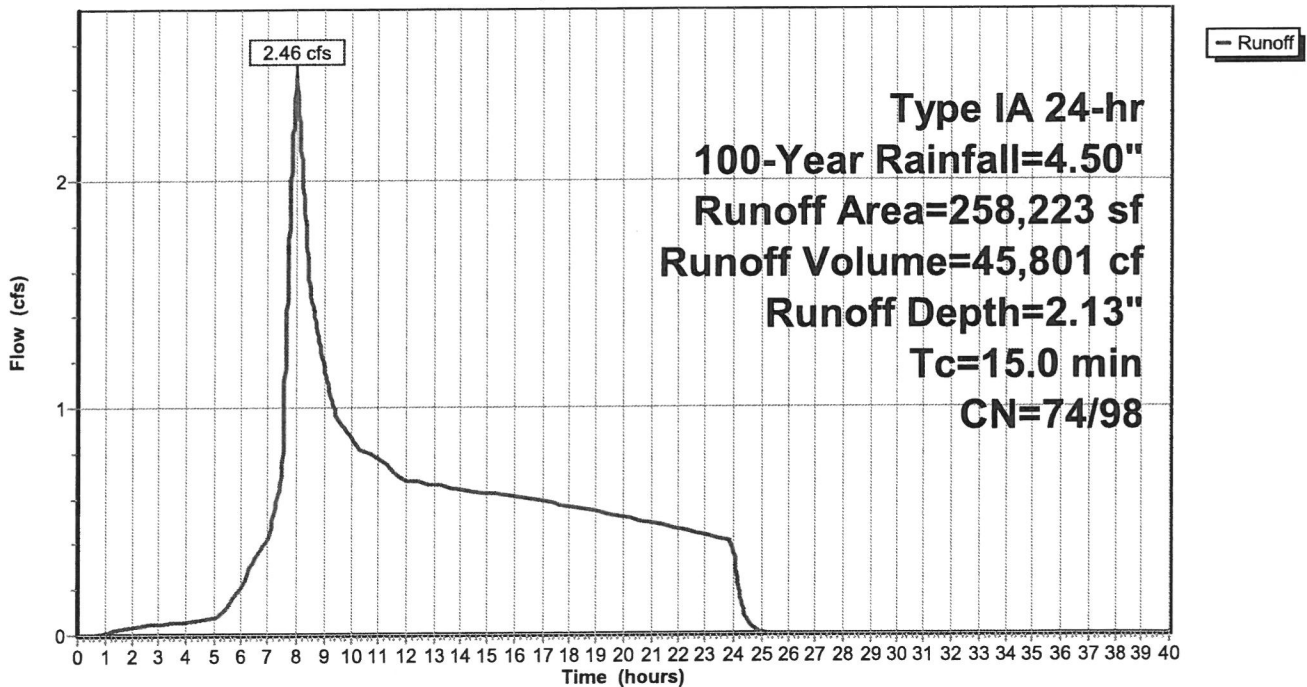

Summary for Subcatchment 201: Upstream Flows

Runoff = 2.51 cfs @ 8.00 hrs, Volume= 46,549 cf, Depth= 2.16"

Runoff by SBUH method, Split Pervious/Imperv., Time Span= 0.00-40.00 hrs, dt= 0.01 hrs
 Type IA 24-hr 100-Year Rainfall=4.50"

Area (sf)	CN	Description
* 7,500	98	3 lots, impervious area
236,718	74	>75% Grass cover, Good, HSG C
* 3,917	98	frontage new ROW
* 10,088	98	Ex. ROW
258,223	76	Weighted Average
236,718	74	91.67% Pervious Area
21,505	98	8.33% Impervious Area

Tc (min)	Length (feet)	Slope (ft/ft)	Velocity (ft/sec)	Capacity (cfs)	Description
15.0					Direct Entry,

Subcatchment 201: Upstream Flows

Hydrograph

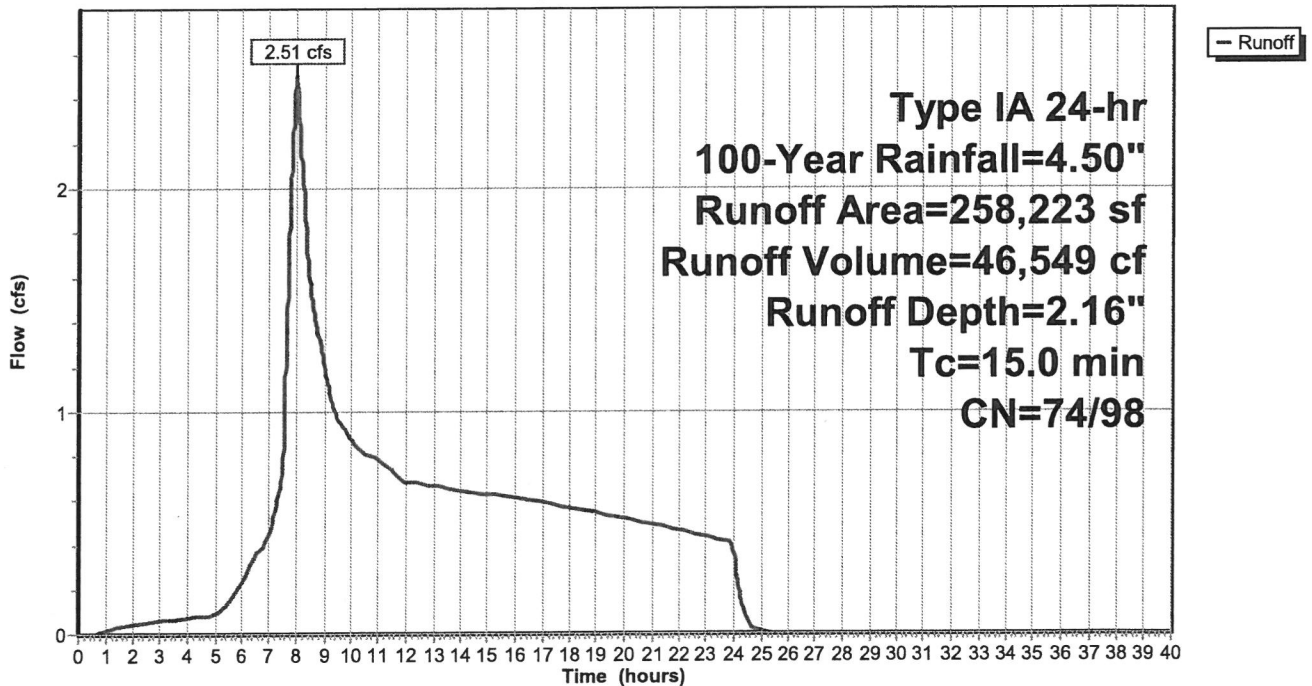

Summary for Pond 1P: Pond

Inflow Area = 410,115 sf, 19.51% Impervious, Inflow Depth = 2.65" for 100-Year event
 Inflow = 5.49 cfs @ 8.00 hrs, Volume= 90,709 cf
 Outflow = 5.40 cfs @ 8.01 hrs, Volume= 90,709 cf, Atten= 2%, Lag= 0.7 min
 Primary = 2.88 cfs @ 8.01 hrs, Volume= 88,046 cf
 Secondary = 0.98 cfs @ 8.01 hrs, Volume= 1,036 cf
 Tertiary = 1.54 cfs @ 8.01 hrs, Volume= 1,627 cf

Routing by Stor-Ind method, Time Span= 0.00-40.00 hrs, dt= 0.01 hrs
 Peak Elev= 532.98' @ 8.01 hrs Surf.Area= 3,074 sf Storage= 7,005 cf

Plug-Flow detention time= 48.9 min calculated for 90,709 cf (100% of inflow)
 Center-of-Mass det. time= 48.9 min (805.3 - 756.3)

Volume	Invert	Avail.Storage	Storage Description
#1	530.50'	14,681 cf	Custom Stage Data (Prismatic) Listed below (Recalc)
Elevation (feet)	Surf.Area (sq-ft)	Inc.Store (cubic-feet)	Cum.Store (cubic-feet)
530.50	2,208	0	0
531.00	2,609	1,204	1,204
532.00	3,015	2,812	4,016
533.00	3,075	3,045	7,061
534.00	4,035	3,555	10,616
535.00	4,095	4,065	14,681

Device	Routing	Invert	Outlet Devices
#1	Primary	529.00'	15.0" Round Culvert L= 20.0' RCP, square edge headwall, Ke= 0.500 Inlet / Outlet Invert= 529.00' / 528.90' S= 0.0050 '/ Cc= 0.900 n= 0.013, Flow Area= 1.23 sf
#2	Device 1	527.82'	4.4" Vert. Low Orifice C= 0.600
#3	Device 2	530.50'	2.000 in/hr Exfiltration over Surface area
#4	Device 2	530.72'	24.0" x 24.0" Horiz. Ditch Inlet #1 C= 0.600 Limited to weir flow at low heads
#5	Device 1	531.70'	8.6" Vert. High Orifice C= 0.600
#6	Secondary	532.87'	24.0" x 24.0" Horiz. Ditch Inlet #2 C= 0.600 Limited to weir flow at low heads
#7	Tertiary	532.87'	48.0" Horiz. Overflow Manhole C= 0.600 Limited to weir flow at low heads

Primary OutFlow Max=2.88 cfs @ 8.01 hrs HW=532.98' (Free Discharge)

- 1=Culvert (Passes 2.88 cfs of 10.83 cfs potential flow)
- 2=Low Orifice (Orifice Controls 1.01 cfs @ 9.61 fps)
- 3=Exfiltration (Passes < 0.14 cfs potential flow)
- 4=Ditch Inlet #1 (Passes < 28.96 cfs potential flow)
- 5=High Orifice (Orifice Controls 1.87 cfs @ 4.63 fps)

Secondary OutFlow Max=0.97 cfs @ 8.01 hrs HW=532.98' (Free Discharge)

- 6=Ditch Inlet #2 (Weir Controls 0.97 cfs @ 1.09 fps)

Tertiary OutFlow Max=1.53 cfs @ 8.01 hrs HW=532.98' (Free Discharge)

- 7=Overflow Manhole (Weir Controls 1.53 cfs @ 1.09 fps)

Pond 1P: Pond

Hydrograph

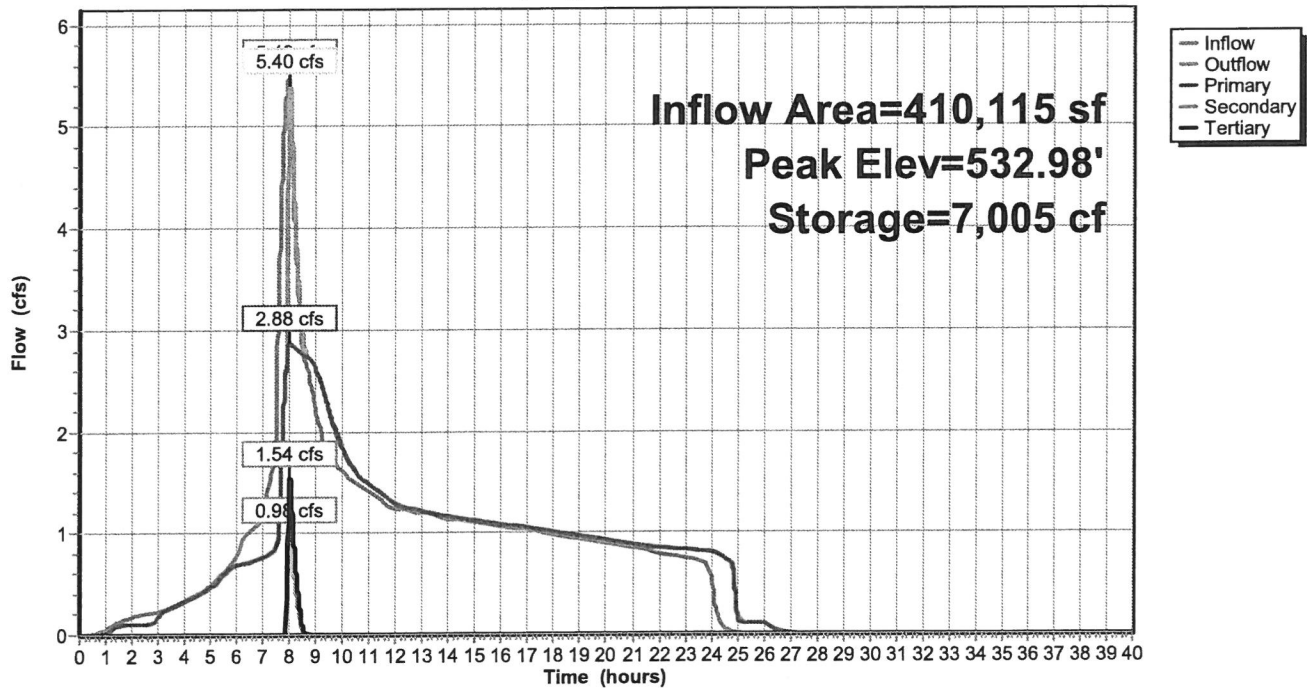

Summary for Link 104L: (new Link)

Inflow Area = 410,115 sf, 4.90% Impervious, Inflow Depth = 2.08" for 100-Year event
Inflow = 3.92 cfs @ 8.00 hrs, Volume= 71,244 cf
Primary = 3.92 cfs @ 8.00 hrs, Volume= 71,244 cf, Atten= 0%, Lag= 0.0 min

Primary outflow = Inflow, Time Span= 0.00-40.00 hrs, dt= 0.01 hrs

Link 104L: (new Link)

Hydrograph

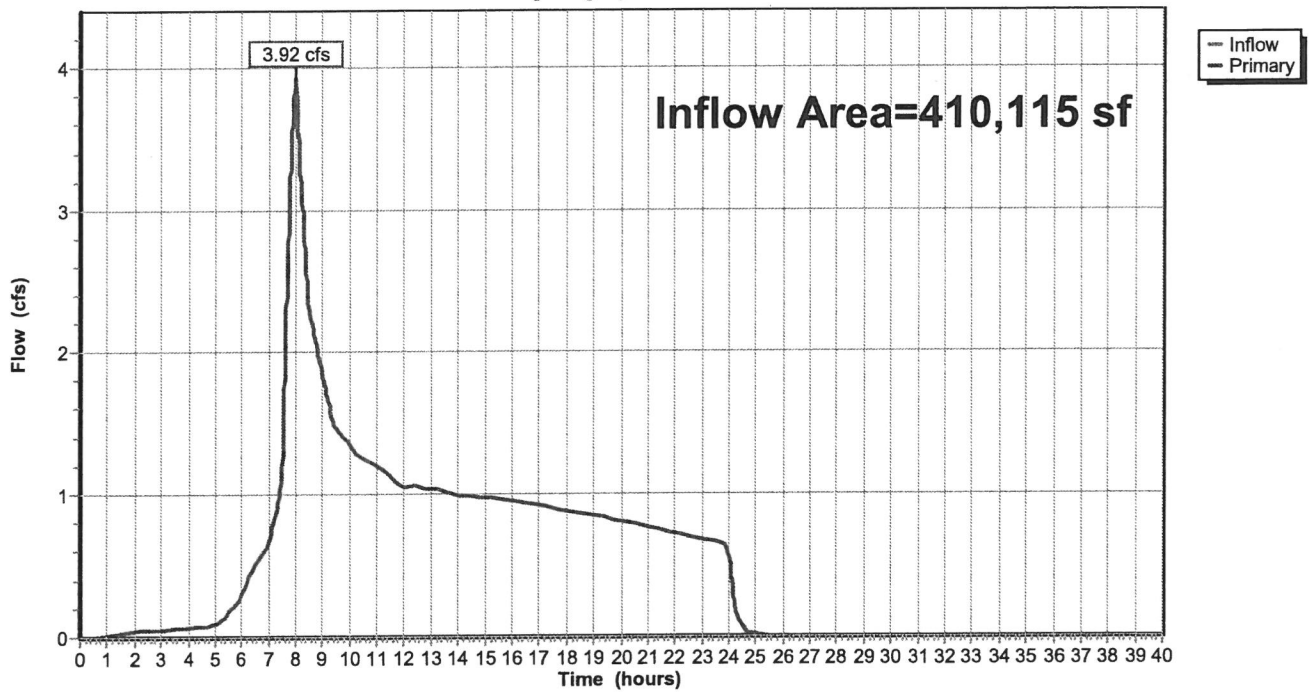

Appendix D:



BASIN ID	SQUARE FEET	ACRES
(10)	151,882 SF	3.48
(20)	236,223 SF	5.53

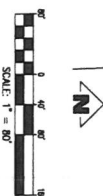

SHEET 1 OF 1	EMERIO <i>Design</i> <small>0440 SW FALLBROOK PLACE, SUITE 100 BURNINGWATER, OREGON 97006 TEL: (503) 748-8812 FAX: (503) 638-8562 www.emeriodesign.com</small>	REVISIONS <table border="1" style="width: 100%; border-collapse: collapse;"> <thead> <tr> <th>NO.</th> <th>DATE</th> <th>DESCRIPTION</th> </tr> </thead> <tbody> <tr> <td style="text-align: center;">0</td> <td style="text-align: center;">5/2019</td> <td style="text-align: center;">PLANNING 1ST SUBMITTAL</td> </tr> </tbody> </table>	NO.	DATE	DESCRIPTION	0	5/2019	PLANNING 1ST SUBMITTAL	POST-DEVELOPED BASIN MAP	23000 23010 SW BLAND CIRCLE TAX MAP 21E35B TAX LOT 400 & 404 WEST LINN, OREGON
NO.	DATE	DESCRIPTION								
0	5/2019	PLANNING 1ST SUBMITTAL								

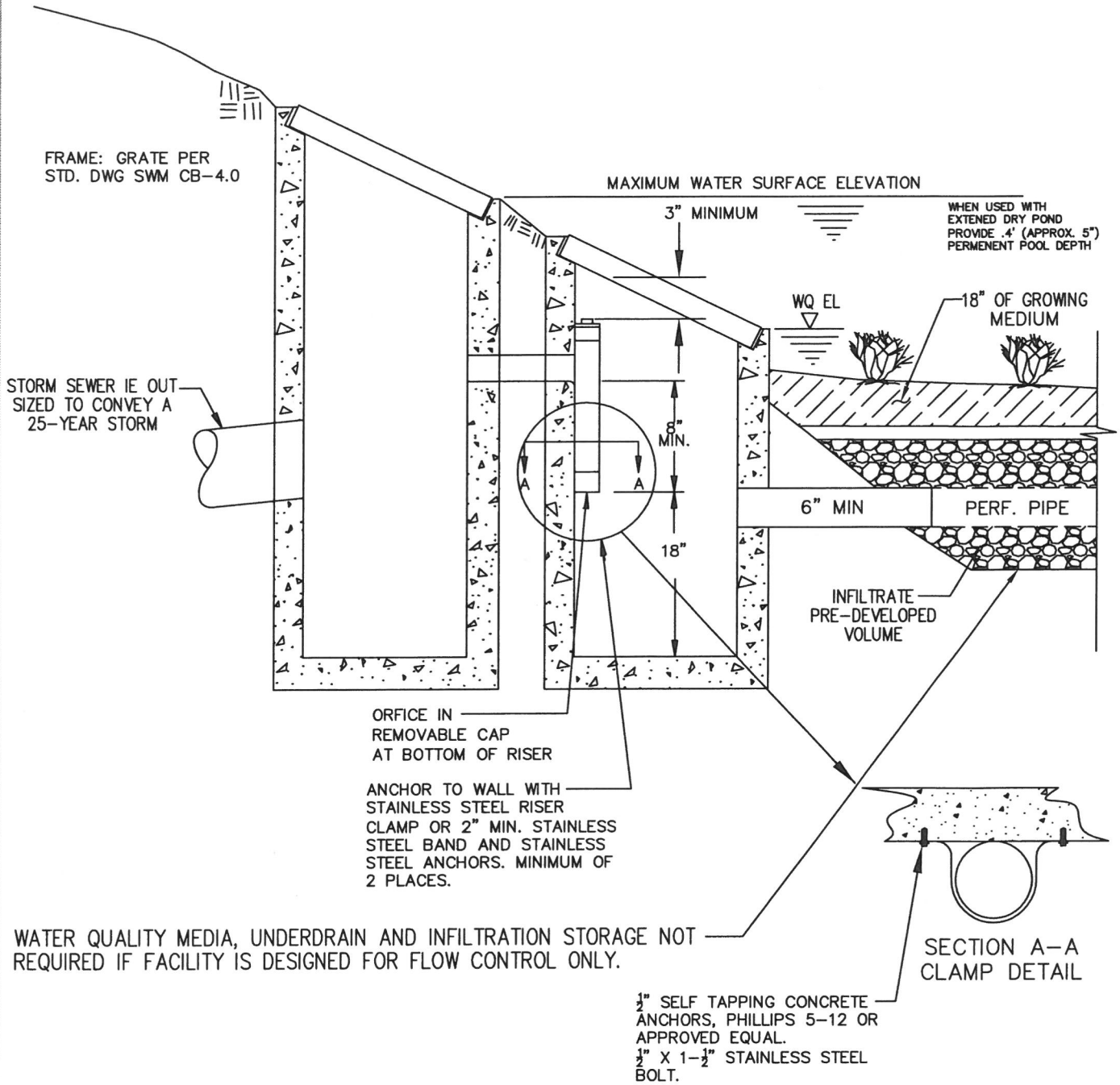

- NOTES:
1. CONNECTING PIPE AND TEE SHALL BE 4", 6", OR 8" AWWA C-900 OR ASTM 3034 PVC, AND ONE SIZE LARGER THAN THE ORFICE OPENING.
 2. MAXIMUM ORFICE OPENING SHALL BE 6" DIAMETER.
 3. STRUCTURES TYPE AND SIZE SHALL CONFORM WITH DETAIL SWM FC-5.0.
 4. FRAME AND GRATE SHALL CONFORM TO CATCH BASIN-FRAME AND GRATE (DETAIL SWM CB-4.0).
 5. SUBMERGED ORFICE AND RISER SHALL BE SECURED FLUSH AGAINST WALL OF STRUCTURE AS APPROVED.
 6. MAINTAINANCE ACCESS REQUIRED TO WITHIN 10' OF CENTER OF BOTH STRUCTURES AND EDGE OF MAINTAINANCE ACCESS ROAD.



CLACKAMAS COUNTY
150 BEAVERCREEK ROAD
OREGON CITY, OR 97045

APPROVAL DATE: 2013 SCALE: N.T.S.

FLOW CONTROL-
STRUCTURE TYPE 3

STANDARD DRAWING
SWM
FC-6.0



Real-World Geotechnical Solutions
Investigation • Design • Construction Support

Updated September 13, 2019
Project No. 18-5089

Ben Looney
Growth Commercial Capitol
511 Main Street #101
Oregon City, Oregon 97045
Via email: ben@growthcc.com

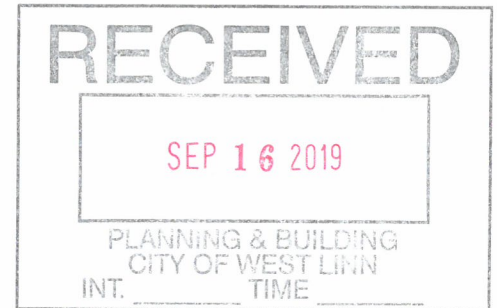

CC: Steve Miller, Emerio Design Via email: stevem@emeriodesign.com

SUBJECT: GEOTECHNICAL REPORT
23000 & 23010 BLAND CIRCLE SUBDIVISION
T2S R1E SECTION 35B TAX LOTS 201, 400, & 404
WEST LINN, OREGON

This report presents the results of a geotechnical engineering study conducted by GeoPacific Engineering, Inc. (GeoPacific) for the above-referenced project. The purpose of our investigation was to evaluate subsurface conditions at the site and to provide geotechnical recommendations for site development. This geotechnical study was performed in accordance with GeoPacific Proposal No. P-6777, dated October 31, 2018, and your subsequent authorization of our proposal and *General Conditions for Geotechnical Services*.

SITE DESCRIPTION AND PROPOSED DEVELOPMENT

The subject site is located on the north side of Bland Circle in West Linn, Clackamas County, Oregon (Figure 1). The property totals approximately 3.5 acres in size and topography is gently to moderately sloping to the southwest at grades of approximately 5 to 20 percent. The site is currently occupied by two homes. Vegetation consists primarily of short grasses and dense to sparse trees.

It is our understanding that the proposed development includes 15 lots for single family homes, new streets, and associated underground utilities (Figure 2). A water quality facility is planned in the southwestern portion of the project. The southern home will be retained and the northern structure will be removed. The grading plan provided for our review indicates maximum cuts will be on the order of 12 feet or less and fills will be minimal. The water quality facility will incorporate retaining walls.

REGIONAL AND LOCAL GEOLOGIC SETTING

The subject site lies within the Willamette Valley/Puget Sound lowland, a broad structural depression situated between the Coast Range on the west and the Cascade Range on the east. A series of discontinuous faults subdivide the Willamette Valley into a mosaic of fault-bounded, structural blocks (Yeats et al., 1996). Uplifted structural blocks form bedrock highlands, while down-warped structural blocks form sedimentary basins.

The site is located on a south facing slope at elevations of approximately 530 to 620 feet above sea level. The subject site is underlain by the Miocene aged (about 14.5 to 16.5 million years ago) Columbia River Basalt Formation, which are a thick sequence of lava flows which form the crystalline basement of the Tualatin Valley (Beeson et al., 1989; Gannett and Caldwell, 1998). The basalts are composed of dense, finely crystalline rock that is commonly fractured along blocky and columnar vertical joints. Individual basalt flow units typically range from 25 to 125 feet thick and interflow zones are typically vesicular, scoriaceous, brecciated, and sometimes include sedimentary rocks.

REGIONAL SEISMIC SETTING

At least three major fault zones capable of generating damaging earthquakes are thought to exist in the vicinity of the subject site. These include the Portland Hills Fault Zone, the Gales Creek-Newberg-Mt. Angel Structural Zone, and the Cascadia Subduction Zone.

Portland Hills Fault Zone

The Portland Hills Fault Zone is a series of NW-trending faults that include the central Portland Hills Fault, the western Oatfield Fault, and the eastern East Bank Fault. These faults occur in a northwest-trending zone that varies in width between 3.5 and 5.0 miles. The combined three faults vertically displace the Columbia River Basalt by 1,130 feet and appear to control thickness changes in late Pleistocene (approx. 780,000 years) sediment (Madin, 1990). The Portland Hills Fault occurs along the Willamette River at the base of the Portland Hills, and is approximately 4.6 miles northeast of the site. The East Bank Fault is oriented roughly parallel to the Portland Hills Fault, on the east bank of the Willamette River, and is located approximately 8.6 miles northwest of the site. The Oatfield Fault occurs along the western side of the Portland Hills, and is approximately 3.8 miles northeast of the site. The Oatfield Fault is considered to be potentially seismogenic (Wong, et al., 2000). Madin and Mabey (1996) indicate the Portland Hills Fault Zone has experienced Late Quaternary (last 780,000 years) fault movement; however, movement has not been detected in the last 20,000 years. The accuracy of the fault mapping is stated to be within 500 meters (Wong, et al., 2000). No historical seismicity is correlated with the mapped portion of the Portland Hills Fault Zone, but in 1991 a M3.5 earthquake occurred on a NW-trending shear plane located 1.3 miles east of the fault (Yelin, 1992). Although there is no definitive evidence of recent activity, the Portland Hills Fault Zone is assumed to be potentially active (Geomatrix Consultants, 1995).

Gales Creek-Newberg-Mt. Angel Structural Zone

The Gales Creek-Newberg-Mt. Angel Structural Zone is a 50-mile-long zone of discontinuous, NW-trending faults that lies approximately 15.6 miles southwest of the subject site. These faults are recognized in the subsurface by vertical separation of the Columbia River Basalt and offset seismic reflectors in the overlying basin sediment (Yeats et al., 1996; Werner et al., 1992). A geologic reconnaissance and photogeologic analysis study conducted for the Scoggins Dam site in the Tualatin Basin revealed no evidence of deformed geomorphic surfaces along the structural zone (Unruh et al., 1994). No seismicity has been recorded on the Gales Creek Fault or Newberg Fault (the fault closest to the subject site); however, these faults are considered to be potentially active because they may connect with the seismically active Mount Angel Fault and the rupture plane of the 1993 M5.6 Scotts Mills earthquake (Werner et al. 1992; Geomatrix Consultants, 1995).

Cascadia Subduction Zone

The Cascadia Subduction Zone is a 680-mile-long zone of active tectonic convergence where oceanic crust of the Juan de Fuca Plate is subducting beneath the North American continent at a rate of 4 cm per year (Goldfinger et al., 1996). A growing body of geologic evidence suggests that prehistoric subduction zone earthquakes have occurred (Atwater, 1992; Carver, 1992; Peterson et al., 1993; Geomatrix Consultants, 1995). This evidence includes: (1) buried tidal marshes recording episodic, sudden subsidence along the coast of northern California, Oregon, and Washington, (2) burial of subsided tidal marshes by tsunami wave deposits, (3) paleoliquefaction features, and (4) geodetic uplift patterns on the Oregon coast. Radiocarbon dates on buried tidal marshes indicate a recurrence interval for major subduction zone earthquakes of 250 to 650 years with the last event occurring 300 years ago (Atwater, 1992; Carver, 1992; Peterson et al., 1993; Geomatrix Consultants, 1995). The inferred seismogenic portion of the plate interface lies roughly along the Oregon coast at depths of between 20 and 40 miles.

SUBSURFACE CONDITIONS

Our site-specific exploration for this report was conducted on November 19, 2018. A total of 4 exploratory test pits were excavated with a small to medium sized trackhoe to depths of 5.5 to 8 feet at the approximate locations indicated on Figure 2. It should be noted that test pit locations were located in the field by pacing or taping distances from apparent property corners and other site features shown on the plans provided. As such, the locations of the explorations should be considered approximate.

A GeoPacific Engineering Geologist continuously monitored the field exploration program and logged the test pits. Soils observed in the explorations were classified in general accordance with the Unified Soil Classification System (USCS). Rock hardness was classified in accordance with Table 1, modified from the ODOT Rock Hardness Classification Chart. During exploration, our geologist also noted geotechnical conditions such as soil consistency, moisture and groundwater conditions. Logs of test pits are attached to this report. The following report sections are based on the exploration program and summarize subsurface conditions encountered at the site.

Table 1. Rock Hardness Classification Chart

ODOT Rock Hardness Rating	Field Criteria	Unconfined Compressive Strength	Typical Equipment Needed For Excavation
Extremely Soft (R0)	Indented by thumbnail	<100 psi	Small excavator
Very Soft (R1)	Scratched by thumbnail, crumbled by rock hammer	100-1,000 psi	Small excavator
Soft (R2)	Not scratched by thumbnail, indented by rock hammer	1,000-4,000 psi	Medium excavator (slow digging with small excavator)
Medium Hard (R3)	Scratched or fractured by rock hammer	4,000-8,000 psi	Medium to large excavator (slow to very slow digging), typically requires chipping with hydraulic hammer or mass excavation)
Hard (R4)	Scratched or fractured w/ difficulty	8,000-16,000 psi	Slow chipping with hydraulic hammer and/or blasting
Very Hard (R5)	Not scratched or fractured after many blows, hammer rebounds	>16,000 psi	Blasting

Undocumented Fill: Undocumented fill was not encountered in our explorations. Our reconnaissance indicates that approximately 5 feet of undocumented fill may be present in the vicinity of the existing driveway of the home at 23010 Bland Circle, as indicated on Figure 2. We anticipate other areas of fill may be present in the vicinity of the existing homes.

Topsoil Horizon: Directly underlying the ground surface in test pits TP-1 through TP-4 was a topsoil horizon consisting of light brown, moderately to highly organic silt (OL-ML). The topsoil horizon was generally loose, contained many fine roots, and extended to a depth of 9 to 12 inches.

Residual Soil: Underlying the topsoil horizon in test pits TP-1 through TP-4 was clayey silt (ML) to silty clay (CL) residual soil resulting from in-place weathering of the underlying Columbia River Basalt Formation. The light reddish brown silty clay to clayey silt contained trace weathered basalt fragments and was generally characterized by a very stiff consistency. In test pits TP-1 through TP-3, the residual soil extended to a depth of 2.5 to 6.5 feet and beyond the maximum depth of exploration in test pit TP-4.

Columbia River Basalt Formation: Underlying the residual soil in test pits TP-1 through TP-3 was weathered basalt belonging to the Columbia River Basalt Formation. Generally, the gray basalt was extremely soft (R0) to soft (R2) with trace light reddish brown silty clay to clayey silt matrix. Practical refusal was encountered on soft (R2) to medium hard (R3) basalt at a depth of 5.5 to 8 feet in test pits TP-1 through TP-3. A larger machine would likely be able to excavate

deeper depths. Table 2 presents the depths at which rock was first encountered in test pits and the depth at which practical refusal was achieved with a small to medium sized trackhoe equipped with rock teeth.

Table 2. Depth of Basalt Bedrock Encountered in Explorations

Test Pit	Depth Rock First Encountered	Depth of Practical Refusal on Medium Hard (R3) Basalt
TP-1	2.5'	5.5'
TP-2	6.5'	8'
TP-3	5.5'	6'

Soil Moisture and Groundwater

On November 19, 2018, neither static groundwater nor groundwater seepage was encountered in test pits excavated to a maximum depth of 8 feet below the ground surface. Regional groundwater mapping indicates that static groundwater is present at a depth of approximately 220 to 280 feet below the ground surface (Snyder, 2008). Experience has shown that temporary storm related perched groundwater within the near surface soils often occur over fine-grained native deposits such as those beneath the site during the wet season and particularly in mottled soils such as were identified in the test pits. It is anticipated that groundwater conditions will vary depending on the season, local subsurface conditions, changes in site utilization, and other factors.

INFILTRATION TESTING

Infiltration testing was not performed due to encountering basalt bedrock. GeoPacific does not recommend infiltrating into bedrock due to limited storage volume.

CONCLUSIONS AND RECOMMENDATIONS

Our investigation indicates that the proposed development is geotechnically feasible, provided that the recommendations of this report are incorporated into the design and sufficient geotechnical monitoring is incorporated into the construction phases of the project. In our opinion, the greatest geotechnical issue for project completion is the depth of the bedrock beneath the site. Weathered basalt bedrock was encountered throughout the site and basalt was first encountered at depths of 2.5 to 6.5 feet. Practical refusal was encountered on medium hard (R3) basalt in test pits TP-1 through TP-3 at depths of 5.5 to 8 feet. A larger excavator may be able to achieve greater depths; however, difficult excavating conditions should be expected.

Site Preparation

Areas of proposed buildings, new streets, and areas to receive fill should be cleared of vegetation and any organic and inorganic debris. Existing buried structures, should be demolished and any cavities structurally backfilled. Inorganic debris and organic materials from clearing should be removed from the site. Existing fill and any organic-rich topsoil should then be stripped from construction areas of the site or where engineered fill is to be placed. Fill was not encountered in our explorations; however, our reconnaissance indicates that fill is likely present in the vicinity of the existing driveway of the southern home as indicated on Figure 2. Other areas of fill are likely present in the vicinity of the existing homes.

Organic-rich topsoil should then be stripped from native soil areas of the site. The estimated depth range necessary for removal of topsoil in cut and fill areas is approximately 6 to 9 inches, respectively. The final depth of soil removal will be determined on the basis of a site inspection after the stripping/excavation has been performed. Stripped topsoil should preferably be removed from the site due to the high density of the proposed development. Any remaining topsoil should be stockpiled only in designated areas and stripping operations should be observed and documented by the geotechnical engineer or his representative.

Any remaining undocumented fills and subsurface structures (tile drains, basements, driveway and landscaping fill, old utility lines, septic leach fields, etc.) should be removed and the excavations backfilled with engineered fill.

Once stripping of a particular area is approved, the area must be ripped or tilled to a depth of 12 inches, moisture conditioned, root-picked, and compacted in-place prior to the placement of engineered fill or crushed aggregate base for pavement. Exposed subgrade soils should be evaluated by the geotechnical engineer. For large areas, this evaluation is normally performed by proof-rolling the exposed subgrade with a fully loaded scraper or dump truck. For smaller areas where access is restricted, the subgrade should be evaluated by probing the soil with a steel probe. Soft/loose soils identified during subgrade preparation should be compacted to a firm and unyielding condition, over-excavated and replaced with engineered fill (as described below), or stabilized with rock prior to placement of engineered fill. The depth of overexcavation, if required, should be evaluated by the geotechnical engineer at the time of construction.

Engineered Fill

All grading for the proposed development should be performed as engineered grading in accordance with the applicable building code at time of construction with the exceptions and additions noted herein. Proper test frequency and earthwork documentation usually requires daily observation and testing during stripping, rough grading, and placement of engineered fill. Imported fill material must be approved by the geotechnical engineer prior to being imported to the site. Oversize material greater than 6 inches in size should not be used within 3 feet of foundation footings, and material greater than 12 inches in diameter should not be used in engineered fill.

Engineered fill should be compacted in horizontal lifts not exceeding 8 inches using standard compaction equipment. We recommend that engineered fill be compacted to at least 95% of the maximum dry density determined by ASTM D698 (Standard Proctor) or equivalent. Field density testing should conform to ASTM D2922 and D3017, or D1556. All engineered fill should be observed and tested by the project geotechnical engineer or his representative. Typically,

one density test is performed for at least every 2 vertical feet of fill placed or every 500 yd³, whichever requires more testing. Because testing is performed on an on-call basis, we recommend that the earthwork contractor be held contractually responsible for test scheduling and frequency.

Site earthwork will be impacted by soil moisture and shallow groundwater conditions. Earthwork in wet weather would likely require extensive use of cement or lime treatment, or other special measures, at a considerable additional cost compared to earthwork performed under dry-weather conditions.

Keyways and Benching For Engineered Fill on Slopes

Engineered fill to be placed in sloping areas inclining steeper than 20% grade should be constructed on a keyway and benches in accordance with the typical design shown in Figure 3. Keyways should have a minimum depth of 2 feet and minimum width of 10 feet. Additional removals of potentially unstable soils may be required depending on conditions observed during construction. Both benches and keyways should be roughly horizontal in the down slope direction, but may slope up to 20% grade along topographic contour. Keyways sloping more than 20% grade along topographic contour should be benched.

The keyway should include a subdrain consisting of a minimum 3-inch diameter, ADS Heavy Duty grade (or equivalent), perforated plastic pipe enveloped in a minimum of 3 cubic feet per lineal foot of 2"-1/2", open-graded gravel drain rock wrapped with geotextile filter fabric (Mirafi 140N or equivalent). GeoPacific should inspect keyways, subdrains and benching prior to fill placement. Areas of potential seepage observed during construction may require a rock blanket drain in the keyway bottom.

We recommend that permanent fill and cut slopes be constructed no steeper than 2H:1V (50% grade). Fill slopes should be overbuilt a minimum of 3 feet horizontally beyond finish grade and then trimmed back to finish grade as shown on Figure 3 in order to achieve a well compacted slope face.

Excavating Conditions and Utility Trenches

We anticipate that on-site soils can be excavated using conventional heavy equipment such as scrapers and trackhoes. Weathered basalt bedrock was encountered in test pits throughout the site at depths of 2.5 to 6.5 feet and practical refusal was encountered on medium hard (R3) basalt at depths of 5.5 to 8 feet in test pits TP-1 through TP-3. A larger excavator may be able to achieve greater depths; however, difficult excavating conditions should be expected.

All temporary cuts in excess of 4 feet in height should be sloped in accordance with U.S. Occupational Safety and Health Administration (OSHA) regulations (29 CFR Part 1926), or be shored. The existing native soil is classified as Type B Soil and temporary excavation side slope inclinations as steep as 1H:1V may be assumed for planning purposes. This cut slope inclination is applicable to excavations above groundwater seepage zones only. Maintenance of safe working conditions, including temporary excavation stability, is the responsibility of the contractor. Actual slope inclinations at the time of construction should be determined based on safety requirements and actual soil and groundwater conditions.

Saturated soils and groundwater may be encountered in utility trenches, particularly during the wet season. We anticipate that dewatering systems consisting of ditches, sumps and pumps

would be adequate for control of perched groundwater. Regardless of the dewatering system used, it should be installed and operated such that in-place soils are prevented from being removed along with the groundwater.

Vibrations created by traffic and construction equipment may cause some caving and raveling of excavation walls. In such an event, lateral support for the excavation walls should be provided by the contractor to prevent loss of ground support and possible distress to existing or previously constructed structural improvements.

PVC pipe should be installed in accordance with the procedures specified in ASTM D2321. We recommend that trench backfill be compacted to at least 95% of the maximum dry density obtained by Modified Proctor ASTM D1557 or equivalent. Initial backfill lift thickness for a ¾"-0 crushed aggregate base may need to be as great as 4 feet to reduce the risk of flattening underlying flexible pipe. Subsequent lift thickness should not exceed 1 foot. If imported granular fill material is used, then the lifts for large vibrating plate-compaction equipment (e.g. hoe compactor attachments) may be up to 2 feet, provided that proper compaction is being achieved and each lift is tested. Use of large vibrating compaction equipment should be carefully monitored near existing structures and improvements due to the potential for vibration-induced damage.

Adequate density testing should be performed during construction to verify that the recommended relative compaction is achieved. Typically, one density test is taken for every 4 vertical feet of backfill on each 200-lineal-foot section of trench.

Erosion Control Considerations

During our field exploration program, we did not observe soil types that would be considered highly susceptible to erosion except in areas of moderately sloping topography. In our opinion, the primary concern regarding erosion potential will occur during construction, in areas that have been stripped of vegetation. Erosion at the site during construction can be minimized by implementing the project erosion control plan, which should include judicious use of straw wattles and silt fences. If used, these erosion control devices should be in place and remain in place throughout site preparation and construction.

Erosion and sedimentation of exposed soils can also be minimized by quickly re-vegetating exposed areas of soil, and by staging construction such that large areas of the project site are not denuded and exposed at the same time. Areas of exposed soil requiring immediate and/or temporary protection against exposure should be covered with either mulch or erosion control netting/blankets. Areas of exposed soil requiring permanent stabilization should be seeded with an approved grass seed mixture, or hydroseeded with an approved seed-mulch-fertilizer mixture.

Wet Weather Earthwork

Soils underlying the site are likely to be moisture sensitive and may be difficult to handle or traverse with construction equipment during periods of wet weather. Earthwork is typically most economical when performed under dry weather conditions. Earthwork performed during the wet-weather season will probably require expensive measures such as cement treatment or imported granular material to compact fill to the recommended engineering specifications. If earthwork is to be performed or fill is to be placed in wet weather or under wet conditions when

soil moisture content is difficult to control, the following recommendations should be incorporated into the contract specifications:

- Earthwork should be performed in small areas to minimize exposure to wet weather. Excavation or the removal of unsuitable soils should be followed promptly by the placement and compaction of clean engineered fill. The size and type of construction equipment used may have to be limited to prevent soil disturbance. Under some circumstances, it may be necessary to excavate soils with a backhoe to minimize subgrade disturbance caused by equipment traffic;
- The ground surface within the construction area should be graded to promote run-off of surface water and to prevent the ponding of water;
- Material used as engineered fill should consist of clean, granular soil containing less than 5 percent fines. The fines should be non-plastic. Alternatively, cement treatment of on-site soils may be performed to facilitate wet weather placement;
- The ground surface within the construction area should be sealed by a smooth drum vibratory roller, or equivalent, and under no circumstances should be left uncompacted and exposed to moisture. Soils which become too wet for compaction should be removed and replaced with clean granular materials;
- Excavation and placement of fill should be observed by the geotechnical engineer to verify that all unsuitable materials are removed and suitable compaction and site drainage is achieved; and
- Geotextile silt fences, straw wattles, and fiber rolls should be strategically located to control erosion.

If cement or lime treatment is used to facilitate wet weather construction, GeoPacific should be contacted to provide additional recommendations and field monitoring.

Pavement Design

For design purposes, we used an estimated resilient modulus of 9,000 for compacted native soil. Table 3 presents our recommended minimum pavement section for dry weather construction.

Table 3. Recommended Minimum Dry-Weather Pavement Section

Material Layer	Light-duty Public Streets	Private Driveways	Compaction Standard
Asphaltic Concrete (AC)	3 in.	2.5 in.	92% of Rice Density AASHTO T-209
Crushed Aggregate Base ¾"-0 (leveling course)	2 in.	2 in.	95% of Modified Proctor AASHTO T-180
Crushed Aggregate Base 1½"-0	8 in.	6 in.	95% of Modified Proctor AASHTO T-180
Subgrade	12 in.	12 in.	95% of Standard Proctor AASHTO T-99 or equivalent

Any pockets of organic debris or loose fill encountered during ripping or tilling should be removed and replaced with engineered fill (see *Site Preparation* Section). In order to verify subgrade strength, we recommend proof-rolling directly on subgrade with a loaded dump truck during dry weather and on top of base course in wet weather. Soft areas that pump, rut, or weave should be stabilized prior to paving. If pavement areas are to be constructed during wet weather, the subgrade and construction plan should be reviewed by the project geotechnical engineer at the time of construction so that condition-specific recommendations can be provided. The moisture sensitive subgrade soils make the site a difficult wet weather construction project.

During placement of pavement section materials, density testing should be performed to verify compliance with project specifications. Generally, one subgrade, one base course, and one asphalt compaction test is performed for every 100 to 200 linear feet of paving.

Spread Foundations

The proposed residential structures may be supported on shallow foundations bearing on competent undisturbed, native soils and/or engineered fill, appropriately designed and constructed as recommended in this report. Foundation design, construction, and setback requirements should conform to the applicable building code at the time of construction. For maximization of bearing strength and protection against frost heave, spread footings should be embedded at a minimum depth of 12 inches below exterior grade. The recommended minimum widths for continuous footings supporting wood-framed walls without masonry are 12 inches for single-story, 15 inches for two-story, and 18 inches for three-story structures. Minimum foundation reinforcement should consist of a No. 4 bar at the tops of stem walls, and a No. 4 bar at the bottom of footings. Concrete slab-on-grade reinforcement should consist of No. 4 bars placed on 24-inch centers in a grid pattern.

The anticipated allowable soil bearing pressure is 1,500 lbs/ft² for footings bearing on competent, native soil and/or engineered fill. A maximum chimney and column load of 30 kips is recommended for the site. The recommended maximum allowable bearing pressure may be increased by 1/3 for short-term transient conditions such as wind and seismic loading. For heavier loads, the geotechnical engineer should be consulted. The coefficient of friction between on-site soil and poured-in-place concrete may be taken as 0.40, which includes no factor of safety. The maximum anticipated total and differential footing movements (generally from soil expansion and/or settlement) are 1 inch and ¾ inch over a span of 20 feet, respectively. We anticipate that the majority of the estimated settlement will occur during construction, as loads are applied. Excavations near structural footings should not extend within a 1H:1V plane projected downward from the bottom edge of footings.

Footing excavations should penetrate through topsoil and any loose soil to competent subgrade that is suitable for bearing support. All footing excavations should be trimmed neat, and all loose or softened soil should be removed from the excavation bottom prior to placing reinforcing steel bars. Due to the moisture sensitivity of on-site native soils, foundations constructed during the wet weather season may require overexcavation of footings and backfill with compacted, crushed aggregate.

Our recommendations are for house construction incorporating raised wood floors and conventional spread footing foundations. If living space of the structures will incorporate basements, a geotechnical engineer should be consulted to make additional recommendations for retaining walls, water-proofing, underslab drainage and wall subdrains. After site

development, a Final Soil Engineer's Report should either confirm or modify the above recommendations.

Permanent Below-Grade Walls

Lateral earth pressures against below-grade retaining walls will depend upon the inclination of any adjacent slopes, type of backfill, degree of wall restraint, method of backfill placement, degree of backfill compaction, drainage provisions, and magnitude and location of any adjacent surcharge loads. At-rest soil pressure is exerted on a retaining wall when it is restrained against rotation. In contrast, active soil pressure will be exerted on a wall if its top is allowed to rotate or yield a distance of roughly 0.001 times its height or greater.

If the subject retaining walls will be free to rotate at the top, they should be designed for an active earth pressure equivalent to that generated by a fluid weighing 35 pcf for level backfill against the wall. For restrained wall, an at-rest equivalent fluid pressure of 55 pcf should be used in design, again assuming level backfill against the wall. These values assume that drainage provisions are incorporated, free draining gravel backfill is used, and hydrostatic pressures are not allowed to develop against the wall.

During a seismic event, lateral earth pressures acting on below-grade structural walls will increase by an incremental amount that corresponds to the earthquake loading. Based on the Mononobe-Okabe equation and peak horizontal accelerations appropriate for the site location, seismic loading should be modeled using the active or at-rest earth pressures recommended above, plus an incremental rectangular-shaped seismic load of magnitude $6.5H$, where H is the total height of the wall.

We assume relatively level ground surface below the base of the walls. As such, we recommend passive earth pressure of 320 pcf for use in design, assuming wall footings are cast against competent native soils or engineered fill. If the ground surface slopes down and away from the base of any of the walls, a lower passive earth pressure should be used and GeoPacific should be contacted for additional recommendations.

A coefficient of friction of 0.42 may be assumed along the interface between the base of the wall footing and subgrade soils. The recommended coefficient of friction and passive earth pressure values do not include a safety factor, and an appropriate safety factor should be included in design. The upper 12 inches of soil should be neglected in passive pressure computations unless it is protected by pavement or slabs on grade.

The above recommendations for lateral earth pressures assume that the backfill behind the subsurface walls will consist of properly compacted structural fill, and no adjacent surcharge loading. If the walls will be subjected to the influence of surcharge loading within a horizontal distance equal to or less than the height of the wall, the walls should be designed for the additional horizontal pressure. For uniform surcharge pressures, a uniformly distributed lateral pressure of 0.3 times the surcharge pressure should be added. Traffic surcharges may be estimated using an additional vertical load of 250 psf (2 feet of additional fill), in accordance with local practice.

The recommended equivalent fluid densities assume a free-draining condition behind the walls so that hydrostatic pressures do not build-up. This can be accomplished by placing a 12 to 18-inch wide zone of sand and gravel containing less than 5 percent passing the No. 200 sieve against the walls. A 3-inch minimum diameter perforated, plastic drain pipe should be installed

at the base of the walls and connected to a suitable discharge point to remove water in this zone of sand and gravel. The drain pipe should be wrapped in filter fabric (Mirafi 140N or other as approved by the geotechnical engineer) to minimize clogging.

Wall drains are recommended to prevent detrimental effects of surface water runoff on foundations – not to dewater groundwater. Drains should not be expected to eliminate all potential sources of water entering a basement or beneath a slab-on-grade. An adequate grade to a low point outlet drain in the crawlspace is required by code. Underslab drains are sometimes added beneath the slab when placed over soils of low permeability and shallow, perched groundwater.

Water collected from the wall drains should be directed into the local storm drain system or other suitable outlet. A minimum 0.5 percent fall should be maintained throughout the drain and non-perforated pipe outlet. Down spouts and roof drains should not be connected to the wall drains in order to reduce the potential for clogging. The drains should include clean-outs to allow periodic maintenance and inspection. Grades around the proposed structure should be sloped such that surface water drains away from the building.

GeoPacific should be contacted during construction to verify subgrade strength in wall keyway excavations, to verify that backslope soils are in accordance with our assumptions, and to take density tests on the wall backfill materials.

Structures should be located a horizontal distance of at least $1.5H$ away from the back of the retaining wall, where H is the total height of the wall. GeoPacific should be contacted for additional foundation recommendations where structures are located closer than $1.5H$ to the top of any wall.

Seismic Design

The Oregon Department of Geology and Mineral Industries (Dogami), Oregon HazVu: 2019 Statewide GeoHazards Viewer indicates that the site is in an area where *very strong* ground shaking is anticipated during an earthquake. Structures should be designed to resist earthquake loading in accordance with the methodology described in the 2015 International Building Code (IBC) with applicable Oregon Structural Specialty Code (OSSC) revisions (current 2014). We recommend Site Class C be used for design per the OSSC, Table 1613.5.2 and as defined in ASCE 7, Chapter 20, Table 20.3-1. Design values determined for the site using the Applied Technology Council (ATC) 2019 Hazards By Location Online Tool are summarized in Table 4, presented on the following page, and are based upon existing soil conditions.

Table 4. Recommended Earthquake Ground Motion Parameters (2010 ASCE-7)

Parameter	Value
Location (Lat, Long), degrees	45.360, -122.654
Mapped Spectral Acceleration Values (MCE):	
Peak Ground Acceleration PGA_M	0.414
Short Period, S_s	0.951 g
1.0 Sec Period, S_1	0.409 g
Soil Factors for Site Class D:	
F_a	1.019
F_v	1.391
Residential Site Value = $2/3 \times F_a \times S_s$	0.647 g
Residential Seismic Design Category	C

Soil liquefaction is a phenomenon wherein saturated soil deposits temporarily lose strength and behave as a liquid in response to earthquake shaking. Soil liquefaction is generally limited to loose, granular soils located below the water table. According to the Oregon HazVu: Statewide Geohazards Viewer, the subject site is regionally characterized as having no risk of soil liquefaction (DOGAMI: HazVu, 2019).

Footing and Roof Drains

Construction should include typical measures for controlling subsurface water beneath the homes, including positive crawlspace drainage to an adequate low-point drain exiting the foundation, visqueen covering the exposed ground in the crawlspace, and crawlspace ventilation (foundation vents). The homebuyers should be informed and educated that some slow flowing water in the crawlspaces is considered normal and not necessarily detrimental to the home given these other design elements incorporated into its construction. Appropriate design professionals should be consulted regarding crawlspace ventilation, building material selection and mold prevention issues, which are outside GeoPacific's area of expertise.

Down spouts and roof drains should collect roof water in a system separate from the footing drains to reduce the potential for clogging. Roof drain water should be directed to an appropriate discharge point and storm system well away from structural foundations. Grades should be sloped downward and away from buildings to reduce the potential for ponded water near structures.

If the proposed structures will have a raised floor, and no concrete slab-on-grade floors in living spaces are used, perimeter footing drains would not be required based on soil conditions encountered at the site and experience with standard local construction practices. Where it is desired to reduce the potential for moist crawl spaces, footing drains may be installed. If concrete slab-on-grade floors are used, perimeter footing drains should be installed as recommended below.

Where necessary, perimeter footing drains should consist of 3 or 4-inch diameter, perforated plastic pipe embedded in a minimum of 1 ft³ per lineal foot of clean, free-draining drain rock. The drain pipe and surrounding drain rock should be wrapped in non-woven geotextile (Mirafi 140N, or approved equivalent) to minimize the potential for clogging and/or ground loss due to piping. A minimum 0.5 percent fall should be maintained throughout the drain and non-

23000 & 23010 Bland Circle Subdivision
Project No. 18-5089

perforated pipe outlet. In our opinion, footing drains may outlet at the curb, or on the back sides of lots where sufficient fall is not available to allow drainage to meet the street.

UNCERTAINTIES AND LIMITATIONS

We have prepared this report for the owner and their consultants for use in design of this project only. This report should be provided in its entirety to prospective contractors for bidding and estimating purposes; however, the conclusions and interpretations presented in this report should not be construed as a warranty of the subsurface conditions. Experience has shown that soil and groundwater conditions can vary significantly over small distances. Inconsistent conditions can occur between explorations that may not be detected by a geotechnical study. If, during future site operations, subsurface conditions are encountered which vary appreciably from those described herein, GeoPacifc should be notified for review of the recommendations of this report, and revision of such if necessary.

Sufficient geotechnical monitoring, testing and consultation should be provided during construction to confirm that the conditions encountered are consistent with those indicated by explorations. The checklist attached to this report outlines recommended geotechnical observations and testing for the project. Recommendations for design changes will be provided should conditions revealed during construction differ from those anticipated, and to verify that the geotechnical aspects of construction comply with the contract plans and specifications.

Within the limitations of scope, schedule and budget, GeoPacifc attempted to execute these services in accordance with generally accepted professional principles and practices in the fields of geotechnical engineering and engineering geology at the time the report was prepared. No warranty, expressed or implied, is made. The scope of our work did not include environmental assessments or evaluations regarding the presence or absence of wetlands or hazardous or toxic substances in the soil, surface water, or groundwater at this site.

We appreciate this opportunity to be of service.

Sincerely,

GEOPACIFIC ENGINEERING, INC.



Beth K. Rapp, C.E.G.
Senior Engineering Geologist

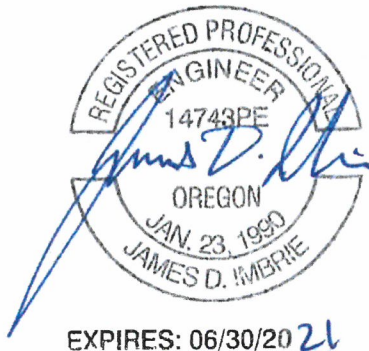

James D. Imbrie, P.E., G.E.
Principal Geotechnical Engineer

Attachments: References
Checklist of Recommended Geotechnical Testing and Observation
Figure 1 – Vicinity Map
Figure 2 – Site and Exploration Plan
Figure 3 – Fill Slope Detail
Test Pit Logs (TP-1 – TP-4)

REFERENCES

- Applied Technology Council (ATC), 2019, Hazards by Location Online Tool, <https://hazards.atcouncil.org/#/seismic>
- Atwater, B.F., 1992, Geologic evidence for earthquakes during the past 2,000 years along the Copalis River, southern coastal Washington: *Journal of Geophysical Research*, v. 97, p. 1901-1919.
- Beeson, M.H., Tolan, T.L., and Madin, I.P., 1989, Geologic map of the Lake Oswego Quadrangle, Clackamas, Multnomah, and Washington Counties, Oregon: Oregon Department of Geology and Mineral Industries Geological Map Series GMS-59, scale 1:24,000.
- Carver, G.A., 1992, Late Cenozoic tectonics of coastal northern California: *American Association of Petroleum Geologists-SEPM Field Trip Guidebook*, May, 1992.
- Gannett, M.W. and Caldwell, R.R., 1998, Geologic framework of the Willamette Lowland aquifer system, Oregon and Washington: U.S. Geological Survey Professional Paper 1424-A, 32 pages text, 8 plates.
- Geomatrix Consultants, 1995, Seismic Design Mapping, State of Oregon: unpublished report prepared for Oregon Department of Transportation, Personal Services Contract 11688, January 1995.
- Goldfinger, C., Kulm, L.D., Yeats, R.S., Appelgate, B., MacKay, M.E., and Cochrane, G.R., 1996, Active strike-slip faulting and folding of the Cascadia Subduction-Zone plate boundary and forearc in central and northern Oregon: in *Assessing earthquake hazards and reducing risk in the Pacific Northwest*, v. 1: U.S. Geological Survey Professional Paper 1560, P. 223-256.
- Madin, I.P., 1990, Earthquake hazard geology maps of the Portland metropolitan area, Oregon: Oregon Department of Geology and Mineral Industries Open-File Report 0-90-2, scale 1:24,000, 22 p.
- Madin, I.P. and Mabey, M.A., 1996, Earthquake Hazard Maps for Oregon, Oregon: Oregon Department of Geology and Mineral Industries GMS-100.
- Oregon Department of Geology and Mineral Industries, 2019, Oregon HazVu: Statewide Geohazards Viewer (HazVu): <http://www.oregongeology.org/hazvu/>
- Peterson, C.D., Darioenzo, M.E., Burns, S.F., and Burris, W.K., 1993, Field trip guide to Cascadia paleoseismic evidence along the northern California coast: evidence of subduction zone seismicity in the central Cascadia margin: *Oregon Geology*, v. 55, p. 99-144.
- Snyder, D.T., 2008, Estimated Depth to Ground Water and Configuration of the Water Table in the Portland, Oregon Area: U.S. Geological Survey Scientific Investigations Report 2008-5059, 41 p., 3 plates.

- Unruh, J.R., Wong, I.G., Bott, J.D., Silva, W.J., and Lettis, W.R., 1994, Seismotectonic evaluation: Scoggins Dam, Tualatin Project, Northwest Oregon: unpublished report by William Lettis and Associates and Woodward Clyde Federal Services, Oakland, CA, for U. S. Bureau of Reclamation, Denver CO (in Geomatrix Consultants, 1995).
- Werner, K.S., Nabelek, J., Yeats, R.S., Malone, S., 1992, The Mount Angel fault: implications of seismic-reflection data and the Woodburn, Oregon, earthquake sequence of August, 1990: *Oregon Geology*, v. 54, p. 112-117.
- Wong, I. Silva, W., Bott, J., Wright, D., Thomas, P., Gregor, N., Li, S., Mabey, M., Sojourner, A., and Wang, Y., 2000, Earthquake Scenario and Probabilistic Ground Shaking Maps for the Portland, Oregon, Metropolitan Area; State of Oregon Department of Geology and Mineral Industries; Interpretative Map Series IMS-15.
- Yeats, R.S., Graven, E.P., Werner, K.S., Goldfinger, C., and Popowski, T., 1996, Tectonics of the Willamette Valley, Oregon: in *Assessing earthquake hazards and reducing risk in the Pacific Northwest*, v. 1: U.S. Geological Survey Professional Paper 1560, P. 183-222, 5 plates, scale 1:100,000.
- Yelin, T.S., 1992, An earthquake swarm in the north Portland Hills (Oregon): More speculations on the seismotectonics of the Portland Basin: *Geological Society of America, Programs with Abstracts*, v. 24, no. 5, p. 92.

CHECKLIST OF RECOMMENDED GEOTECHNICAL TESTING AND OBSERVATION

Item No.	Procedure	Timing	By Whom	Done
1	Preconstruction meeting	Prior to beginning site work	Contractor, Developer, Civil and Geotechnical Engineers	
2	Fill removal from site or sorting and stockpiling	Prior to mass stripping	Soil Technician/ Geotechnical Engineer	
3	Stripping, aeration, and root-picking operations	During stripping	Soil Technician	
4	Compaction testing of engineered fill (90% of Modified Proctor)	During filling, tested every 2 vertical feet	Soil Technician	
5	Compaction testing of trench backfill (95% of Standard Proctor)	During backfilling, tested every 4 vertical feet for every 200 lineal feet	Soil Technician	
6	Street Subgrade Compaction (95% of Standard Proctor)	Prior to placing base course	Soil Technician	
7	Base course compaction (95% of Modified Proctor)	Prior to paving, tested every 200 lineal feet	Soil Technician	
8	AC Compaction (92% (bottom lift) / 92% (top lift) of Rice)	During paving, tested every 200 lineal feet	Soil Technician	
9	Final Geotechnical Engineer's Report	Completion of project	Geotechnical Engineer	



14835 SW 72nd Avenue
Portland, Oregon 97224
Tel: (503) 598-8445 Fax: (503) 941-9281

VICINITY MAP

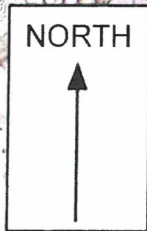
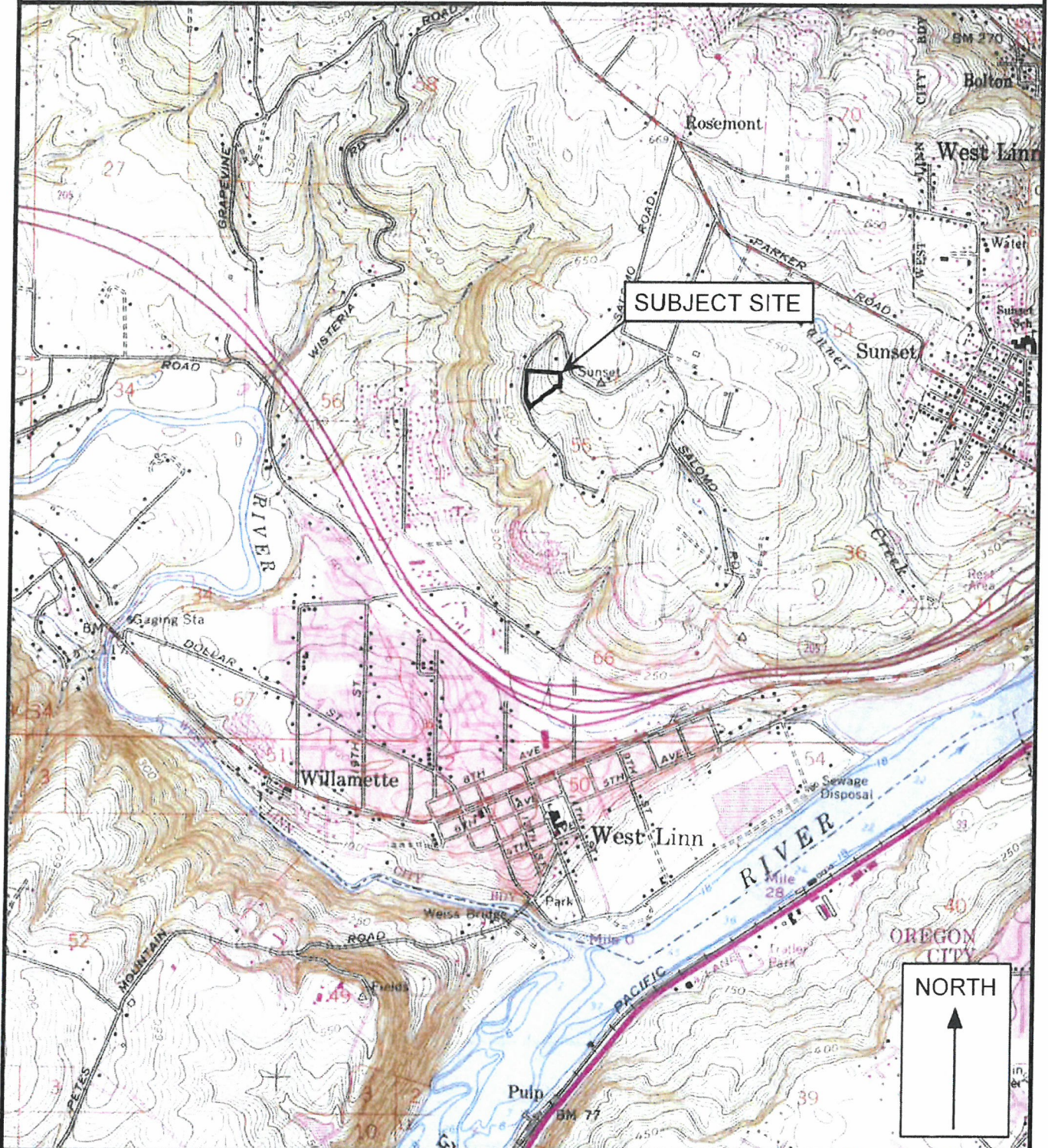

Legend

Approximate Scale 1 in = 2,000 ft

Date: 9/13/2019
Drawn by: EKR

Base map: U.S. Geological Survey 7.5 minute Topographic Map Series, Canby, Oregon Quadrangle, 1961 (Photorevised 1985).

Project: 23000 & 23010 Bland Circle
West Linn, Oregon

Project No. 18-5089

FIGURE 1

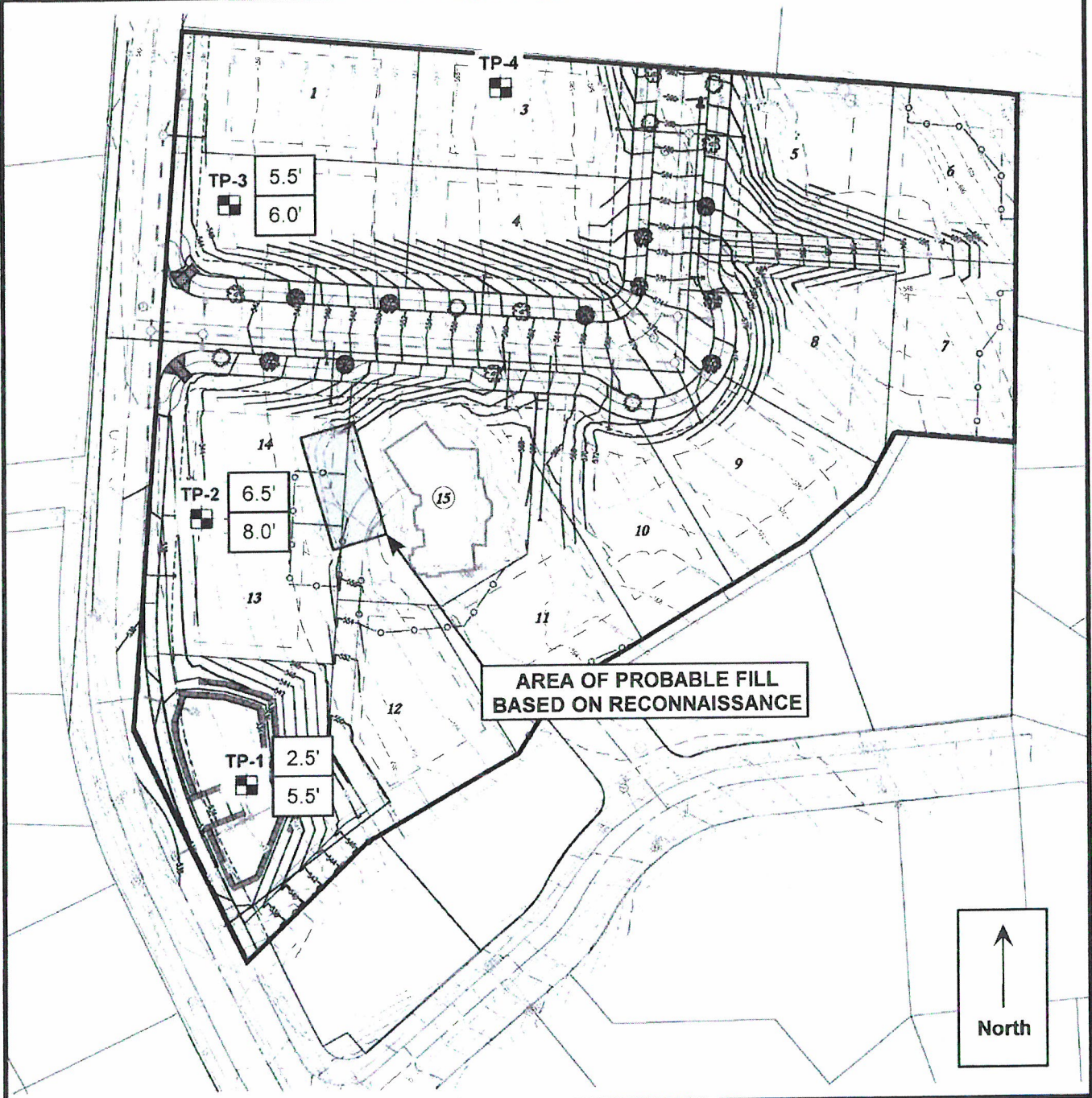

TP-1



Test Pit Designation and Approximate Location

2.5'

2.5' = Depth at Which Rock is First Encountered

5.5'

5.5' = Depth of Practical Refusal on Rock

>10' = Depth of Practical Refusal Exceeds Depth of Exploration

Date: 9/13/2019

Drawn by: EKR

0 80'

APPROXIMATE SCALE 1"=80'

TYPICAL KEYWAY, BENCHING & FILL SLOPE DETAIL

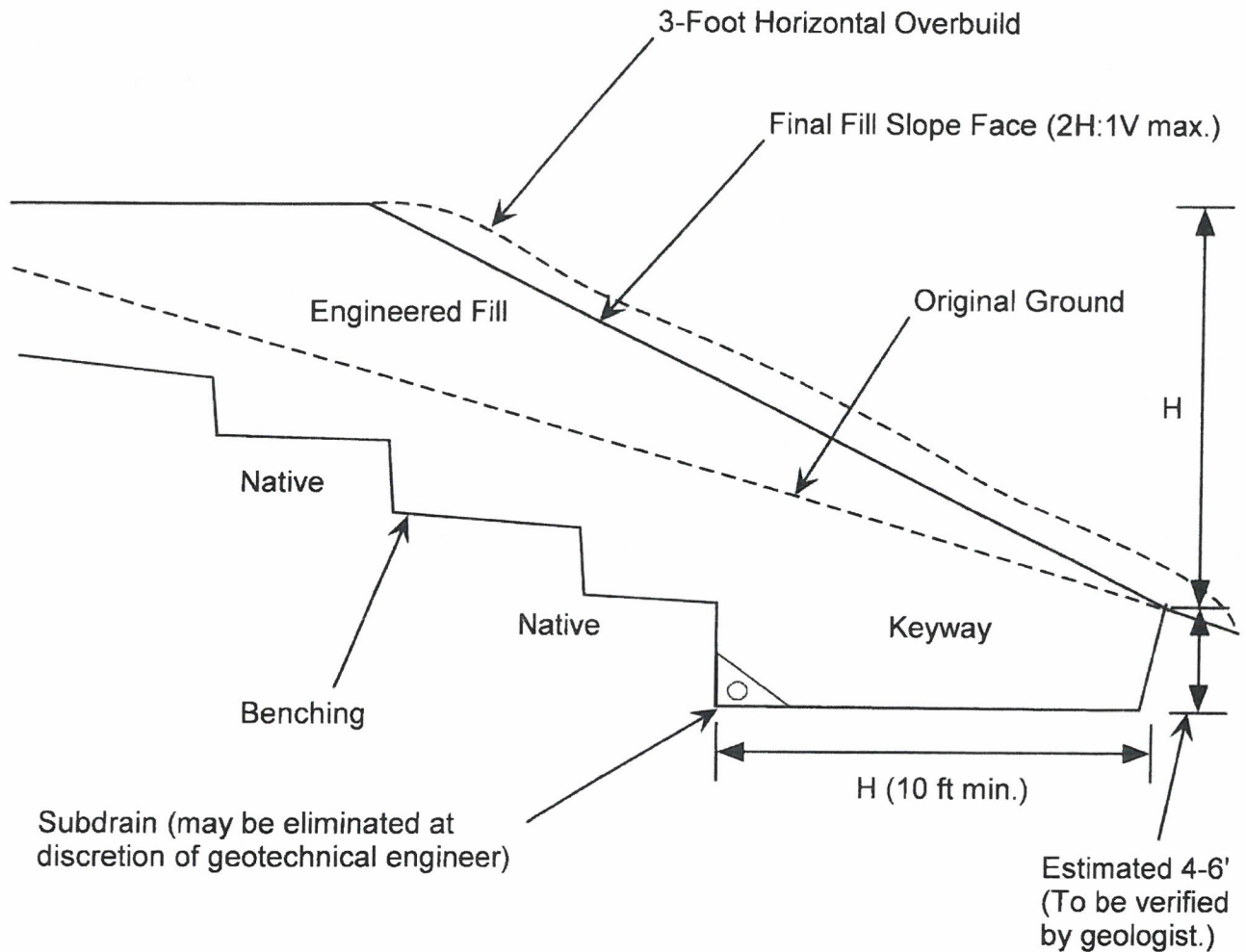

Recommended subdrain is minimum 3-inch-diameter ADS Heavy Duty grade (or equivalent), perforated plastic pipe enveloped in a minimum of 3 cubic feet per lineal foot of 2" to 1/2" open-graded gravel drain rock wrapped with geotextile filter fabric (Mirafi 140N or equivalent).



14835 SW 72nd Avenue
 Portland, Oregon 97224
 Tel: (503) 598-8445 Fax: (503) 941-9281

TEST PIT LOG

Project: 23000 & 23010 Bland Circle
 West Linn, Oregon

Project No. 18-5089

Test Pit No. **TP-1**

Depth (ft)	Pocket Penetrometer (tons/ft ²)	Sample Type	In-Situ Dry Density (lb/ft ³)	Moisture Content (%)	Water Bearing Zone	Material Description
1	2.5					Moderately organic SILT (OL-ML), brown, loose, fine roots throughout, moist (Topsoil Horizon)
2	4.5					Very stiff, silty CLAY (CL) to clayey SILT (ML), light reddish brown, subtle orange and gray mottling, trace fine roots throughout, damp to moist (Residual Soil)
3	4.5					Extremely soft (R0) to very soft (R1), highly weathered BASALT, trace light reddish brown silty clay to clayey silt matrix, gray, trace black staining, vesicular, fractured, damp to moist (Columbia River Basalt Formation)
4	4.5					
6						Practical Refusal on Soft (R2) Basalt at 5.5 Feet.
7						Note: No seepage or groundwater encountered.
8						
9						
10						
11						
12						

LEGEND



100 to 1,000 g
Bag Sample



5 Gal Bucket



Shelby Tube Sample



Seepage



Water Bearing Zone



Water Level at Abandonment

Date Excavated: 11/19/2018

Logged By: B. Rapp

Surface Elevation:



14835 SW 72nd Avenue
 Portland, Oregon 97224
 Tel: (503) 598-8445 Fax: (503) 941-9281

TEST PIT LOG

Project: 23000 & 23010 Bland Circle
 West Linn, Oregon

Project No. 18-5089

Test Pit No. **TP-2**

Depth (ft)	Pocket Penetrometer (tons/ft ²)	Sample Type	In-Situ Dry Density (lb/ft ³)	Moisture Content (%)	Water Bearing Zone	Material Description
1	4.5					Moderately organic SILT (OL-ML), brown, loose, fine roots throughout, damp to moist (Topsoil Horizon)
2	4.5					Very stiff, silty CLAY (CL) to clayey SILT (ML), trace gray basalt fragments, light reddish brown, subtle orange and gray mottling, trace fine roots to 2.5 feet, damp to moist (Residual Soil)
3	4.5					
4	4.5					
5						
6						
7						Extremely soft (R0) to very soft (R1), highly weathered BASALT, trace light reddish brown silty clay to clayey silt matrix, gray, trace black staining, vesicular, damp to moist (Columbia River Basalt Formation)
8						Practical Refusal on Soft (R2) Basalt at 8 Feet.
9						Note: No seepage or groundwater encountered.
10						
11						
12						

LEGEND



100 to 1,000 g



5 Gal Bucket



Shelby Tube Sample



Seepage



Water Bearing Zone



Water Level at Abandonment

Date Excavated: 11/19/2018

Logged By: B. Rapp

Surface Elevation:



14835 SW 72nd Avenue
 Portland, Oregon 97224
 Tel: (503) 598-8445 Fax: (503) 941-9281

TEST PIT LOG

Project: 23000 & 23010 Bland Circle
 West Linn, Oregon

Project No. 18-5089

Test Pit No. **TP-3**

Depth (ft)	Pocket Penetrometer (tons/ft ²)	Sample Type	In-Situ Dry Density (lb/ft ³)	Moisture Content (%)	Water Bearing Zone	Material Description
1	1.0					Moderately to highly organic SILT (OL-ML), brown, loose, fine roots throughout, damp to moist (Topsoil Horizon)
2	4.5					Very stiff, silty CLAY (CL) to clayey SILT (ML), trace gray basalt fragments below 5 feet, light reddish brown, subtle orange and gray mottling, trace fine roots to 3 feet, damp to moist (Residual Soil)
3	4.5					
4	4.5					
5						Soft (R2) BASALT, trace light reddish brown silty clay to clayey silt matrix, gray, trace black staining, vesicular, damp to moist (Columbia River Basalt Formation)
6						
7						Practical Refusal on Soft (R2) to Medium Hard (R3) Basalt at 6 Feet.
8						Note: No seepage or groundwater encountered.
9						
10						
11						
12						

LEGEND



100 to 1,000 g
Bag Sample



5 Gal Bucket
Bucket Sample



Shelby Tube Sample



Seepage



Water Bearing Zone



Water Level at Abandonment

Date Excavated: 11/19/2018

Logged By: B. Rapp

Surface Elevation:



14835 SW 72nd Avenue
 Portland, Oregon 97224
 Tel: (503) 598-8445 Fax: (503) 941-9281

TEST PIT LOG

Project: 23000 & 23010 Bland Circle
 West Linn, Oregon

Project No. 18-5089

Test Pit No. **TP-4**

Depth (ft)	Pocket Penetrometer (tons/ft ²)	Sample Type	In-Situ Dry Density (lb/ft ³)	Moisture Content (%)	Water Bearing Zone	Material Description
1	2.0					Moderately organic SILT (OL-ML), dark brown, loose, fine roots throughout, moist (Topsoil Horizon)
2	4.5					Very stiff, silty CLAY (CL) to clayey SILT (ML), trace subrounded to subangular gray basalt fragments below 6 feet, light reddish brown, subtle orange and gray mottling, damp to moist (Residual Soil)
3	4.5					
4	4.5					
5						
6						
7						
8						Test Pit Terminated at 8 Feet.
9						Note: No seepage or groundwater encountered.
10						
11						
12						

LEGEND



100 to 1,000 g
Bag Sample



5 Gal Bucket Sample



Shelby Tube Sample



Seepage



Water Bearing Zone



Water Level at Abandonment

Date Excavated: 11/19/2018

Logged By: B. Rapp

Surface Elevation:

BLAND CIRCLE SUBDIVISION

15 LOT SUBDIVISION
NW 1/4 SECTION 35, T. 2S, R. 1E, W.M.
CITY OF WEST LINN, OREGON

GENERAL LEGEND

	LANDSCAPE HEDGE
	FLOW LINE
	FENCE
	EXISTING MAJOR CONTOUR LINE
	EXISTING MINOR CONTOUR LINE
	PROPOSED MAJOR CONTOUR LINE
	PROPOSED MINOR CONTOUR LINE
	SIGNIFICANT RESOURCE OVERLAY ZONE (SROZ)
	SANITARY SEWER LINE
	STORM DRAIN LINE
	GAS LINE
	WATER LINE
	OVERHEAD UTILITIES LINE
	UNDERGROUND UTILITIES LINE
	COMMUNICATIONS LINE
	ELECTRIC LINE
	FIRE HYDRANT
	AIR RELEASE
	WATER BLOWOFF
	WATER METER/SERVICE
	WATER VAULT
	IRRIGATION SPRINKLER HEAD
	CULVERT / OUTFALL
	STORM DRAIN MANHOLE
	CATCH BASIN / AREA DRAIN
	SANITARY SEWER MANHOLE
	UTILITY MANHOLE
	UTILITY CLEAN OUT
	UTILITY VALVE
	UTILITY POLE
	UTILITY GUY POLE
	UTILITY GUY WIRE
	UTILITY/LIGHT POLE
	LIGHT POLE
	LIGHT POLE WITH ARM
	LIGHT SIGNAL JUNCTION BOX
	JUNCTION BOX
	ELECTRIC METER/SERVICE
	ELECTRIC PEDESTAL
	ELECTRIC VAULT
	TELEPHONE MANHOLE
	COMMUNICATIONS PEDESTAL
	COMMUNICATIONS VAULT
	GAS METER/SERVICE
	GAS PEDESTAL
	DECIDUOUS TREE
	EVERGREEN TREE
	SIGN POST
	MAILBOX
	SIDEWALK TO BE INSTALLED AT TIME OF STREET CONSTRUCTION

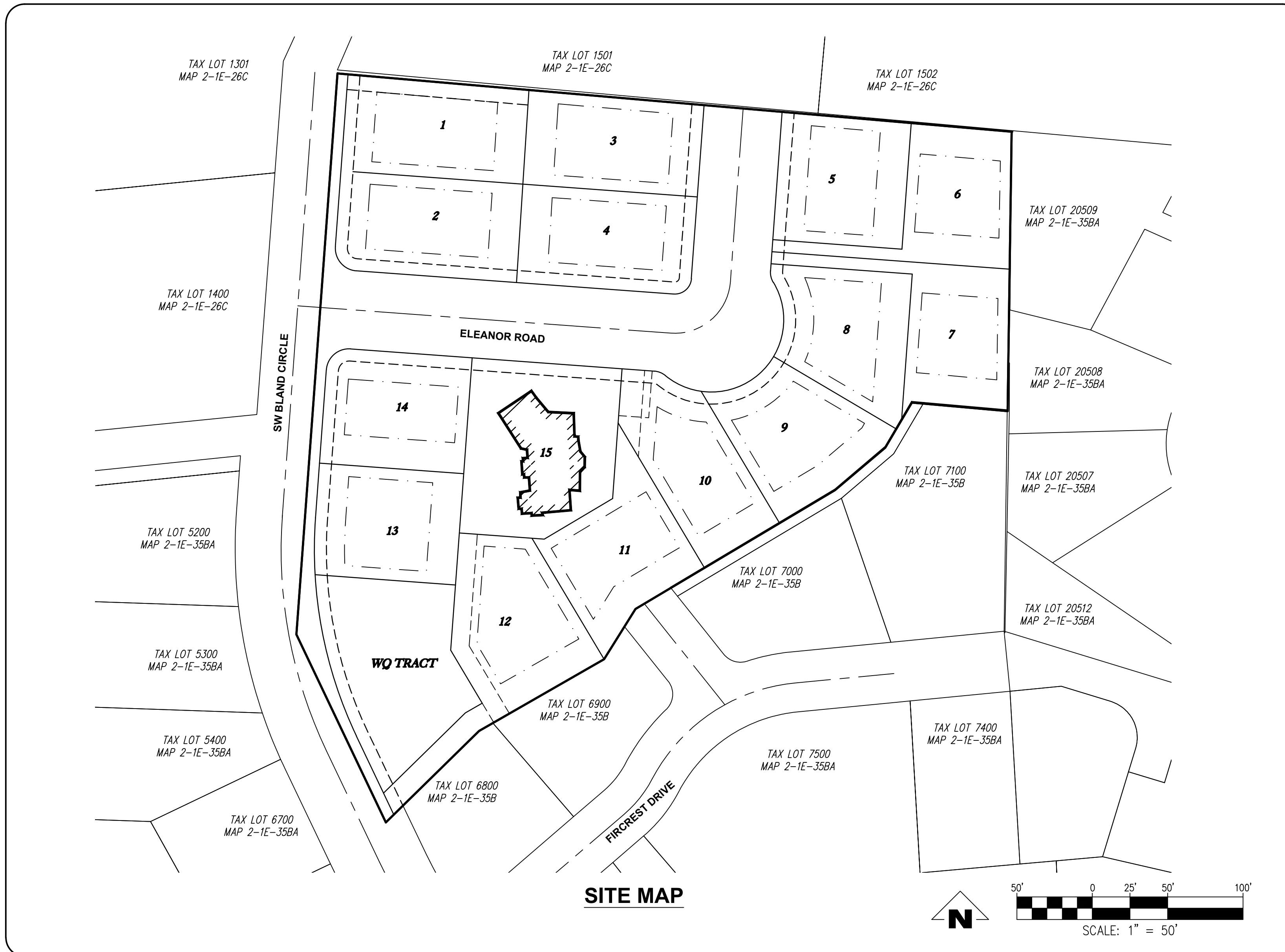

VICINITY MAP

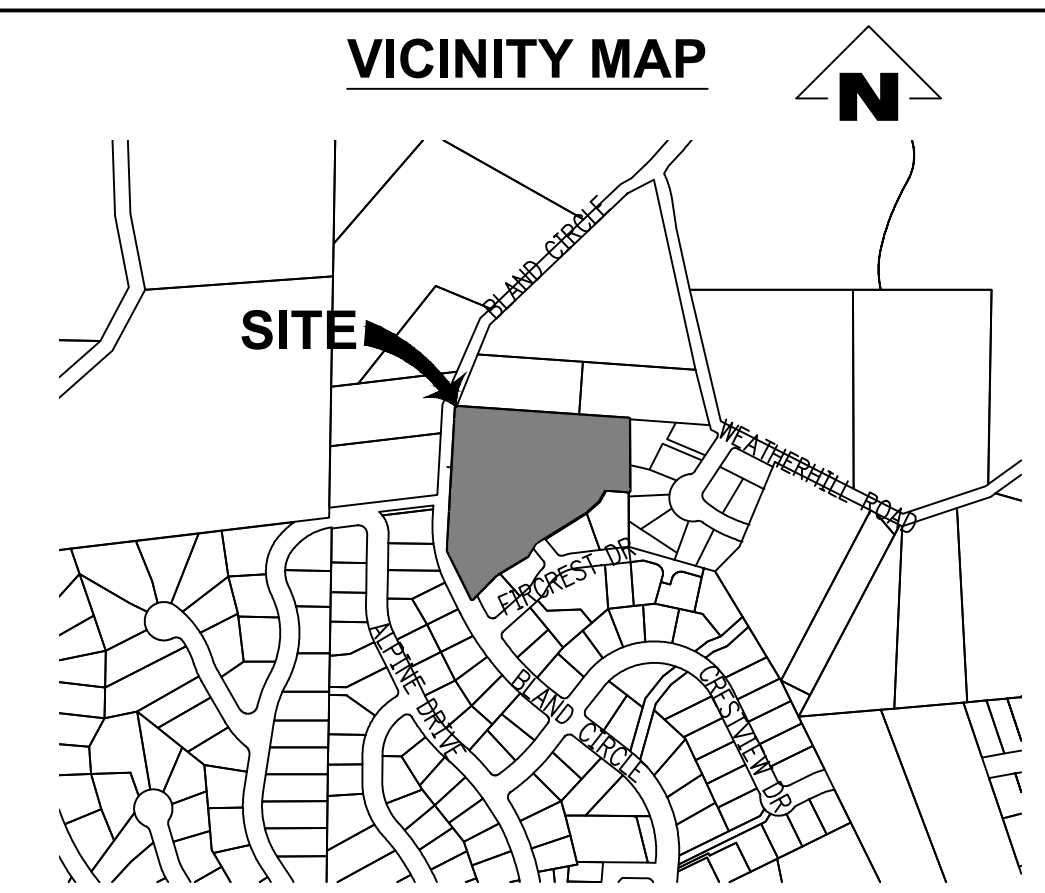

DRAWING INDEX

NO.	TITLE
1	COVER SHEET
2	EXISTING CONDITIONS
3	TREE PLAN
4	TREE PRESERVATION DETAILS
5	TREE PRESERVATION DETAILS
6	SLOPE ANALYSIS PLAN
7	PRELIMINARY PLAT
8	COMPOSITE GRADING PLAN
9	COMPOSITE UTILITY PLAN
10	ELEANOR PLAN & PROFILE
11	BLAND CIRCLE PLAN & PROFILE
12	WATER QUALITY POND & DETAILS
13	LIGHTING PLAN

NOTICE TO EXCAVATORS:
ATTENTION: OREGON LAW REQUIRES YOU TO FOLLOW RULES ADOPTED BY THE OREGON UTILITY NOTIFICATION CENTER. THOSE RULES ARE SET FORTH IN OAR 952-001-0010 THROUGH OAR 952-001-0090. YOU MAY OBTAIN COPIES OF THE RULES BY CALLING THE CENTER.
(NOTE: THE TELEPHONE NUMBER FOR THE OREGON UTILITY NOTIFICATION CENTER IS (503)-232-1987).

POTENTIAL UNDERGROUND FACILITY OWNERS

Dig Safely.

Call the Oregon One-Call Center
DIAL 811 or 1-800-332-2344

EMERGENCY TELEPHONE NUMBERS

NW NATURAL GAS	M-F 7am-6pm	503-226-4211 Ext.4313
AFTER HOURS		503-226-4211
PGE		503-464-7777
CENTURY LINK		1-800-491-0118
FRONTIER		1-800-921-8101
CITY OF WEST LINN PUBLIC WORKS		503-635-0238

ENGINEER'S NOTE TO CONTRACTOR

THE EXISTENCE AND LOCATION OF ANY UNDERGROUND UTILITIES OR STRUCTURES SHOWN ON THESE PLANS ARE OBTAINED BY A SEARCH OF AVAILABLE RECORDS. TO THE BEST OF OUR KNOWLEDGE, THERE ARE NO EXISTING UTILITIES EXCEPT THOSE SHOWN ON THESE PLANS. THE CONTRACTOR IS REQUIRED TO TAKE DUE PRECAUTIONARY MEASURES TO PROTECT THE UTILITY LINES SHOWN ON THESE DRAWINGS. THE CONTRACTOR FURTHER ASSUMES ALL LIABILITY AND RESPONSIBILITY FOR THE UTILITY PIPES, CONDUITS OR STRUCTURES SHOWN OR NOT SHOWN ON THESE DRAWINGS.

THE CONTRACTOR AGREES THAT HE SHALL ASSUME SOLE AND COMPLETE RESPONSIBILITY FOR THE JOB SITE CONDITIONS DURING THE COURSE OF CONSTRUCTION OF THIS PROJECT, INCLUDING SAFETY OF ALL PERSONS AND PROPERTY, THAT THIS SHALL APPLY CONTINUOUSLY AND NOT BE LIMITED TO NORMAL WORKING HOURS, AND THAT THE CONTRACTOR SHALL DEFEND, INDEMNIFY AND HOLD THE OWNER AND THE ENGINEER HARMLESS FROM ANY AND ALL LIABILITY, REAL OR ALLEGED, IN CONNECTION WITH THE PERFORMANCE OF WORK ON THIS PROJECT, EXCEPT FOR LIABILITY ARISING FROM THE SOLE NEGLIGENCE OF THE OWNER OR THE ENGINEER.

CONTRACTOR SHALL VERIFY ALL CONDITIONS AND DIMENSIONS AND SHALL REPORT ANY DISCREPANCIES TO THE ENGINEER PRIOR TO THE COMMENCEMENT OF WORK.

BENCHMARK INFORMATION

THE DATUM FOR THIS SURVEY IS BASED UPON OREGON REAL-TIME GNSS NETWORK (ORGN).

DATUM = NGVD 29

SITE DATA

AREA:	2.84 Ac.
ZONING:	R-7
TAX MAP:	T2SR1E35B
TAX LOT:	400 & 404
NO. OF LOTS:	15

PROJECT CONTACTS

APPLICANT:

BLAND CIRCLE LLC
ATTN: BEN LOONEY
511 MAIN STREET, SUITE 101
OREGON CITY, OR 97045
PH: (541) 404-8825
BEN@GROWTHCC.COM

OWNERS:

ROBERT & CAMERON BAUER
23000 BLAND CIRCLE, WEST LINN, OR 97068
PH: (503) 807-5837
ROBERTBAUER04@GMAIL.COM

JOHN & LYNN NILSEN
23010 BLAND CIRCLE, WEST LINN, OR 97068
PH: (503) 657-0132

LAND USE, CIVIL ENGINEER AND SURVEYOR:

EMERIO DESIGN, LLC
6445 SW FALLBROOK PL., SUITE 100
BEAVERTON, OR 97008
LAND USE CONTACT: STEVE MILLER
ENGINEER CONTACT: ERIC EVANS
SURVEYOR CONTACT: KING PHELPS
(503) 746-8812 (P)
(503) 639-9592 (F)

23000 23010 SW BLAND CIRCLE

TAX MAP 21E35B
TAX LOT 400 & 404
WEST LINN, OREGON

COVER SHEET

REVISIONS

NO.	DATE	DESCRIPTION
0	6/2019	PLANNING 1ST SUBMITTAL

EMERIO
Design

6445 SW FALLBROOK PLACE, SUITE 100
BEAVERTON, OREGON 97008
TEL: (503) 746-8812
FAX: (503) 639-9592
www.emeriodesign.com

FILE: P:\0540-001_23000_23010 SW Bland Cir\Wq\plan\0540-001_Dicovr Layout: 1 COVER SHEET, Plot Date: 10/14/2019 11:34 AM, by: Joke Snyder

SHEET

1

OF

13

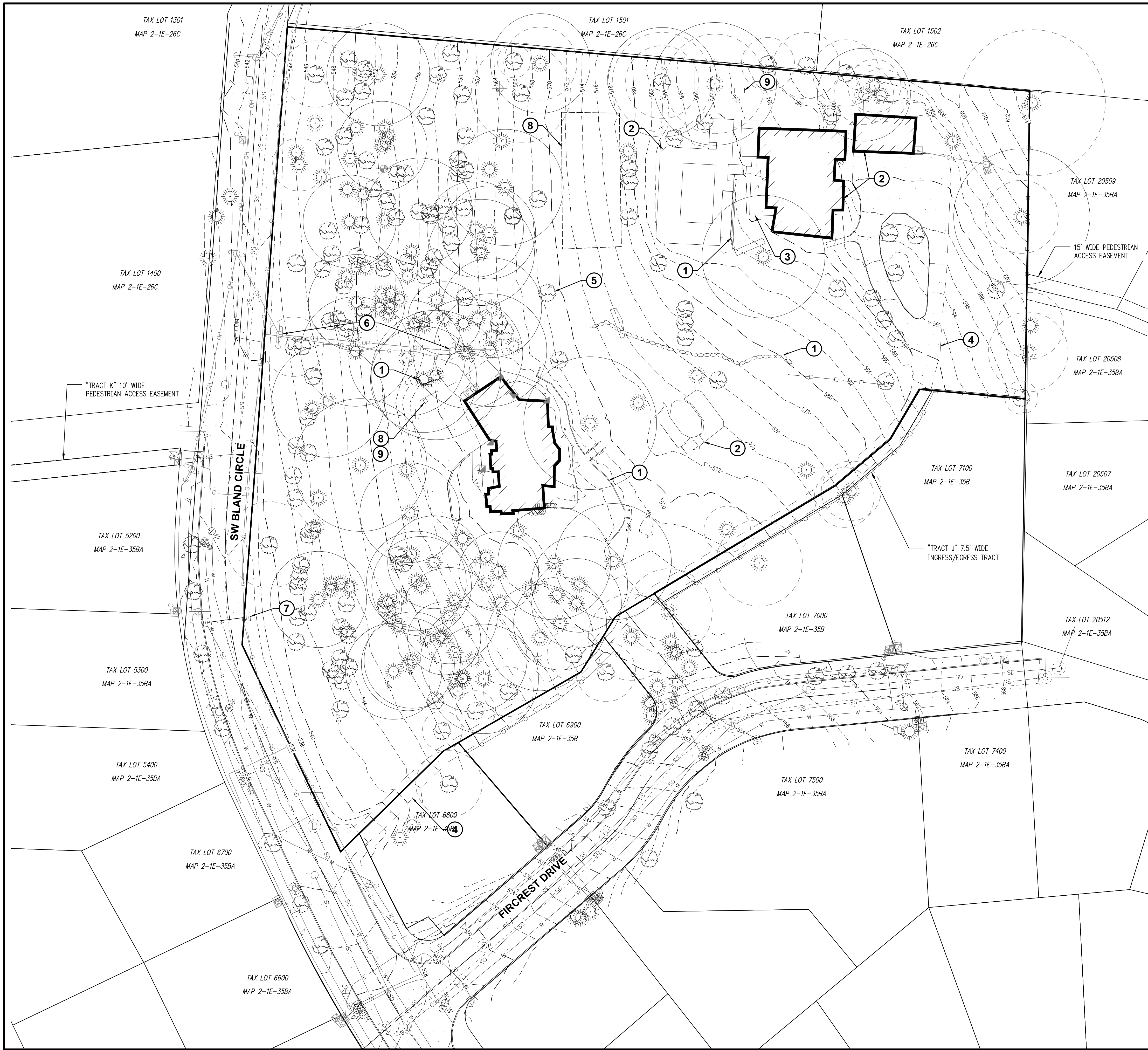

DEMOLITION KEY NOTES

- ① REMOVED EXISTING WALL
- ② REMOVED EXISTING BUILDING/STRUCTURE
- ③ REMOVE EXISTING CONCRETE AREAS
- ④ REMOVE EXISTING AC DRIVEWAY
- ⑤ REMOVE EXISTING TREE (TYP.). SEE SHEET 3 & 4 FOR DETAILED TREE PLANS
- ⑥ REMOVE EXISTING POWER POLE. POWER TO BE UNDERGROUNDED.
- ⑦ DITCH INLET TO BE REMOVED & REPLACED WITH GRATED INLET. STORM LINE ACROSS SW BLAND CIRCLE TO BE REMOVED.
- ⑧ CONTRACTOR TO LOCATE EXISTING ON SITE SEPTIC SYSTEMS & DECOMMISSION PER STATE REGULATIONS.
- ⑨ CONTRACTOR TO LOCATE & DECOMMISSION EXISTING WELLS PER STATE REGULATIONS. WELLS COULD NOT BE LOCATED AT TIME OF SURVEY, BUT WERE CONFIRMED PRESENT PER OREGON WATER RESOURCES DEPARTMENT WELL LOGS "CLAC 3870" & "CLAC 3871"

GENERAL NOTES:

- A. SEE SHEETS 3 AND 4 FOR TREE PRESERVATION PLAN. TREE PROTECTION TO BE INSTALLED BEFORE ANY SITE DEMOLITION, GRUBBING, OR CLEARING.

SURVEYOR'S NOTE

THE DATUM FOR THIS SURVEY IS BASED UPON OREGON REAL-TIME GNSS NETWORK (ORGN). NAVD88. A TOPCON PS104B, TRIMBLE RS INSTRUMENTS WERE USED TO COMPLETE THIS SURVEY. BOUNDARIES WERE DRAWN PER PLAT AND MONUMENTS FOUND. NO PROPERTY CORNERS WERE SET IN THIS SURVEY.

NO WARRANTIES ARE MADE AS TO MATTERS OF UNWRITTEN TITLE, SUCH AS ADVERSE POSSESSION, ESTOPPEL, ACQUIESCENCE, ETC.

THE UNDERGROUND UTILITIES AS SHOWN ON THIS MAP HAVE BEEN LOCATED FROM FIELD SURVEY OF ABOVE GROUND STRUCTURES AND AS MARKED BY OTHERS. THE SURVEYOR MAKES NO GUARANTEE THAT THE UNDERGROUND UTILITIES SHOWN COMPROMISE ALL SUCH UTILITIES IN THE AREA, EITHER IN SERVICE OR ABANDONED. THE SURVEYOR FURTHER DOES NOT WARRANT THAT THE UNDERGROUND UTILITIES ARE IN THE EXACT LOCATION INDICATED, ALTHOUGH HE DOES CERTIFY THAT THEY ARE LOCATED AS ACCURATELY AS POSSIBLE FROM INFORMATION AVAILABLE. THE SURVEYOR HAS NOT PHYSICALLY LOCATED THE UNDERGROUND UTILITIES. SUBSURFACE AND ENVIRONMENTAL CONDITIONS WERE NOT EXAMINED OR CONSIDERED AS A PART OF THIS SURVEY. NO STATEMENT IS MADE CONCERNING THE EXISTENCE OF UNDERGROUND OR OVERHEAD CONTAINERS OR FACILITIES THAT MAY AFFECT THE USE OR DEVELOPMENT OF THIS TRACT. THIS SURVEY DOES NOT CONSTITUTE A TITLE SEARCH BY SURVEYOR.

NO TITLE REPORT WAS SUPPLIED OR USED IN THE PREPARATION OF THIS MAP. THERE MAY EXIST EASEMENTS, CONDITIONS, OR RESTRICTIONS THAT COULD AFFECT THE TITLE OF THIS PROPERTY. NO ATTEMPT HAS BEEN MADE IN THIS SURVEY TO SHOW SUCH MATTERS THAT MAY AFFECT TITLE.

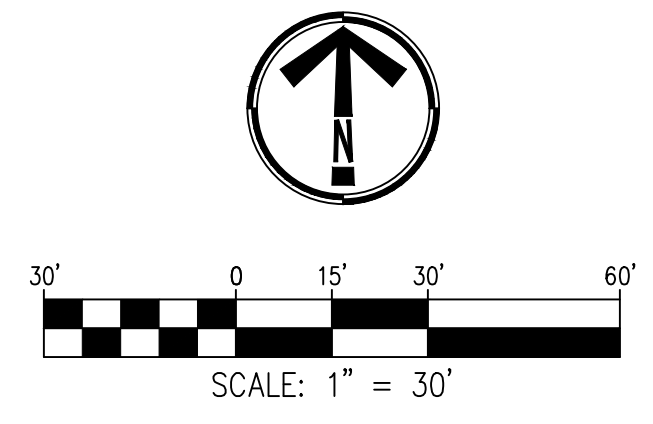

EXISTING CONDITIONS PLAN

SCALE: 1"=30'

23000 23010 SW BLAND CIRCLE
TAX MAP 21E35B
TAX LOT 400 & 404
WEST LINN, OREGON

EXISTING CONDITIONS & DEMOLITION PLAN

REVISIONS	
NO.	DATE
0	6/2019
DESCRIPTION PLANNING 1ST SUBMITTAL	

EMERIO Design
 6445 SW FALLBROOK PLACE, SUITE 100
 WEST LINN, OREGON 97136
 TEL: (503) 746-8812
 FAX: (503) 639-9592
 www.emeriodesign.com

FILE: P:\0540-001_23000 SW Bland Cir\wpj\plan\0540-001_02etg.dwg, Layout: EXISTING CONDITIONS, Plot Date: 10/18/2019 3:03 PM, by: Joke Snyder



- SIGNIFICANT EVERGREEN TREE
- SIGNIFICANT DECIDUOUS TREE
- INSIGNIFICANT EVERGREEN TREE
- INSIGNIFICANT DECIDUOUS TREE
- SIGNIFICANT TREE CANOPY RETAINED
- SIGNIFICANT TREE CANOPY REMOVED
- CRITICAL ROOT PROTECTION ZONE

GENERAL TREE INVENTORY	
TOTAL PROPERTY AREA	123,710 SF (2.84 AC)
TOTAL TREE INVENTORY	276
TOTAL TREES RETAINED	55
TOTAL TREES REMOVED	221

SIGNIFICANT TREES INVENTORY	
ONSITE SIGNIFICANT TREE INVENTORY	58
SIGNIFICANT TREES RETAINED	13
SIGNIFICANT TREES REMOVED	45
EXISTING SIGNIFICANT TREE CANOPY COVERAGE	78,004 SF
TREE PRESERVATION AREA REQUIRED (20% OF EXISTING SIGNIFICANT TREE CANOPY)	15,601 SF
TREE PRESERVATION AREA PROVIDED	16,669 SF

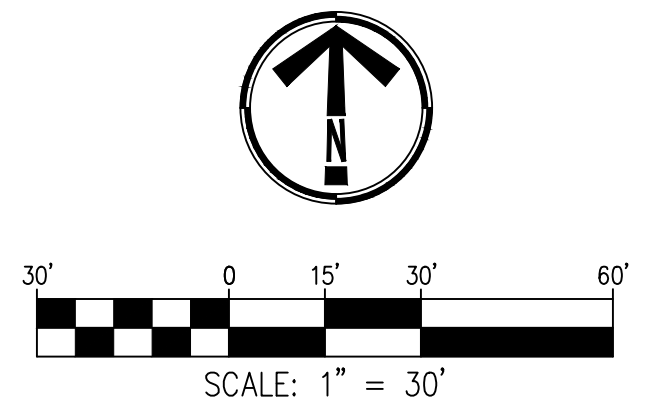

PRELIM TREE REMOVAL PLAN
SCALE: 1" = 30'

23000 23010 SW BLAND CIRCLE
TAX MAP 21E35B
TAX LOT 400 & 404
WEST LINN, OREGON

PRELIMINARY TREE PLAN

REVISIONS		
NO.	DATE	DESCRIPTION
0	6/2019	PLANNING 1ST SUBMITTAL

EMERIO
Design

6445 SW FALLBROOK PLACE, SUITE 100
BEAVERTON, OREGON 97008
TEL: (503) 746-8812
FAX: (503) 639-9592
www.emeriodesign.com

FILE: P:\0540-001_23000_23010 SW Bland Cir\lwp\plan\0540-001_03tree Layout: TREE PLAN, Plot Date: 10/4/2019 11:38 AM, by: Jake Snyder

Tree No.	Common Name	Scientific Name	DBH ¹	Single DBH ²	C-Rad ³	Condition ⁴	Structure	Sig. ⁵	Comments	Treatment
50094	n/a	n/a	n/a	n/a	n/a	n/a	n/a	n/a	not located	n/a
50095	n/a	n/a	n/a	n/a	n/a	n/a	n/a	n/a	not located	n/a
50096	n/a	n/a	n/a	n/a	n/a	n/a	n/a	n/a	not located	n/a
50290	Douglas-fir	<i>Pseudotsuga menziesii</i>	36	36	26	good	fair	no	codominant at 2' with included bark, size estimated	retain
50291	Douglas-fir	<i>Pseudotsuga menziesii</i>	34	34	22	good	fair	no	side pruned for overhead power	retain
50292	Douglas-fir	<i>Pseudotsuga menziesii</i>	14	14	22	poor	poor	no	topped for overhead power	retain
50295	English oak	<i>Quercus robur</i>	1.5	1.5	2	fair	fair	no	average nursery stock	retain
50298	English oak	<i>Quercus robur</i>	1.5	1.5	2	fair	fair	no	average nursery stock	retain
50302	English oak	<i>Quercus robur</i>	13	13	21	good	fair	no	multiple leaders	retain
50303	English oak	<i>Quercus robur</i>	13	13	18	good	fair	no	multiple leaders	retain
50402	oak	<i>Quercus sp.</i>	11	11	16	good	fair	no	multiple leaders	retain
50403	English oak	<i>Quercus robur</i>	12	12	15	good	fair	no	codominant at 8' with included bark	retain
50407	English oak	<i>Quercus robur</i>	14	14	19	good	fair	no	multiple leaders	retain
50609	English oak	<i>Quercus robur</i>	12	12	16	good	fair	no	multiple leaders, girdling roots	remove
50610	English oak	<i>Quercus robur</i>	15	15	23	good	fair	no	multiple leaders	remove
50899	Raywood ash	<i>Fraxinus angustifolia</i> 'Raywood'	4	4	6	good	fair	no	multiple leaders	retain
50900	Raywood ash	<i>Fraxinus angustifolia</i> 'Raywood'	5	5	7	fair	fair	no	multiple leaders, significant lean towards street	retain
50901	Raywood ash	<i>Fraxinus angustifolia</i> 'Raywood'	8	8	12	good	fair	no	multiple leaders	retain
50933	Raywood ash	<i>Fraxinus angustifolia</i> 'Raywood'	8	8	13	good	fair	no	multiple leaders	retain
50936	Raywood ash	<i>Fraxinus angustifolia</i> 'Raywood'	5	5	10	good	fair	no	multiple leaders	retain
50937	Raywood ash	<i>Fraxinus angustifolia</i> 'Raywood'	3	3	6	poor	poor	no	thin crown, sunscald	retain
50938	Raywood ash	<i>Fraxinus angustifolia</i> 'Raywood'	4	4	6	poor	poor	no	thin crown, sunscald, significant epicormic growth	retain
50939	Raywood ash	<i>Fraxinus angustifolia</i> 'Raywood'	6	6	12	fair	fair	no	multiple leaders, significant lean towards street	retain

Tree No.	Common Name	Scientific Name	DBH ¹	Single DBH ²	C-Rad ³	Condition ⁴	Structure	Sig. ⁵	Comments	Treatment
51361	Douglas-fir	<i>Pseudotsuga menziesii</i>	25	25	22	good	fair	yes	one sided, surrounded by retaining wall	remove
51362	Douglas-fir	<i>Pseudotsuga menziesii</i>	26	26	29	good	fair	yes	one sided, surrounded by retaining wall	remove
51363	Douglas-fir	<i>Pseudotsuga menziesii</i>	24	24	20	good	fair	yes	moderately one sided	remove
51364	Douglas-fir	<i>Pseudotsuga menziesii</i>	5	5	10	poor	poor	no	suppressed	remove
51365	bigleaf maple	<i>Acer macrophyllum</i>	6	6	17	fair	fair	no	one sided	remove
51366	Douglas-fir	<i>Pseudotsuga menziesii</i>	8	8	16	poor	poor	no	suppressed	remove
51367	bigleaf maple	<i>Acer macrophyllum</i>	12	12	14	poor	poor	no	overtopped by adjacent trees, significant dieback	remove
51368	Douglas-fir	<i>Pseudotsuga menziesii</i>	20	20	18	good	fair	yes	moderately one sided	remove
51369	Douglas-fir	<i>Pseudotsuga menziesii</i>	21	21	20	good	fair	yes	one sided, marginal trunk taper	remove
51370	Douglas-fir	<i>Pseudotsuga menziesii</i>	21	21	20	good	fair	yes	one sided, marginal trunk taper	remove
51371	Douglas-fir	<i>Pseudotsuga menziesii</i>	9	9	12	poor	poor	no	suppressed	remove
51372	Douglas-fir	<i>Pseudotsuga menziesii</i>	23	23	19	good	fair	yes	moderately one sided	remove
51373	Douglas-fir	<i>Pseudotsuga menziesii</i>	15	15	12	fair	poor	no	poor trunk taper, 33% lcr, crown extensive suppressed by adjacent trees	remove
51374	Douglas-fir	<i>Pseudotsuga menziesii</i>	21	21	12	fair	fair	yes	one sided, crown extension suppressed by adjacent trees	remove
51375	Douglas-fir	<i>Pseudotsuga menziesii</i>	10	10	3	poor	poor	no	suppressed, significant dieback, <i>Phellinus pini</i> infection	remove
51376	Douglas-fir	<i>Pseudotsuga menziesii</i>	22	22	22	good	fair	yes	one sided	remove
51377	Douglas-fir	<i>Pseudotsuga menziesii</i>	19	19	17	good	fair	no	one sided	remove
51378	madrone	<i>Arbutus menziesii</i>	7	7	4	poor	poor	no	suppressed, significant dieback	remove
51384	Douglas-fir	<i>Pseudotsuga menziesii</i>	11	11	9	poor	poor	no	suppressed	remove
51385	Douglas-fir	<i>Pseudotsuga menziesii</i>	11	11	13	fair	fair	no	one sided, marginal trunk taper	remove
51386	madrone	<i>Arbutus menziesii</i>	8	8	8	fair	fair	no	overtopped by adjacent trees, lower branch dieback	remove
51387	Douglas-fir	<i>Pseudotsuga menziesii</i>	12	12	11	fair	poor	no	one sided, 33% lcr, poor trunk taper	remove
51387.1	Douglas-fir	<i>Pseudotsuga menziesii</i>	13	13	14	fair	fair	no	one sided, marginal trunk taper, added to site map in approximate location by arborist	remove

Tree No.	Common Name	Scientific Name	DBH ¹	Single DBH ²	C-Rad ³	Condition ⁴	Structure	Sig. ⁵	Comments	Treatment
51450	Douglas-fir	<i>Pseudotsuga menziesii</i>	18	18	16	fair	poor	no	40% lcr, marginal trunk taper	remove
51451	Douglas-fir	<i>Pseudotsuga menziesii</i>	18	18	16	very poor	very poor	no	<i>Phaeolus schwenitzii</i> conk at base of trunk, one sided, poor trunk taper	remove
51512	orchard apple	<i>Malus domestica</i>	9	9	16	fair	fair	no	not maintained for fruit production	remove
51538	Douglas-fir	<i>Pseudotsuga menziesii</i>	48	48	20	good	good	yes	70% lcr	remove
51544	bigleaf maple	<i>Acer macrophyllum</i>	28	28	23	fair	poor	no	multiple leaders at 1' with decay, stump sprout	remove
51545	Douglas-fir	<i>Pseudotsuga menziesii</i>	23	23	25	good	fair	yes	one sided	remove
51546	madrone	<i>Arbutus menziesii</i>	19	19	13	poor	poor	no	overtopped by adjacent trees, 50% dead	remove
51547	n/a	n/a	n/a	n/a	n/a	n/a	n/a	n/a	same as 51546	n/a
51548	Douglas-fir	<i>Pseudotsuga menziesii</i>	21	21	18	fair	fair	yes	one sided, previously lost top at 50' with new top	remove
51549	Douglas-fir	<i>Pseudotsuga menziesii</i>	20	20	22	good	fair	yes	one sided, codominant at 30'	remove
51550	bigleaf maple	<i>Acer macrophyllum</i>	9	9	24	poor	poor	no	suppressed	remove
51551	Douglas-fir	<i>Pseudotsuga menziesii</i>	22	22	19	good	fair	yes	60% lcr, significant P. pini along trunk	remove
51552	Douglas-fir	<i>Pseudotsuga menziesii</i>	19	19	22	good	fair	yes	one sided, marginal trunk taper	retain
51553	Douglas-fir	<i>Pseudotsuga menziesii</i>	28	28	20	good	fair	yes	moderately one sided	retain
51554	bigleaf maple	<i>Acer macrophyllum</i>	34	34	30	poor	poor	no	significant decay at base of trunk, multiple leaders, large past scaffold failures	remove
51555	bigleaf maple	<i>Acer macrophyllum</i>	7	7	13	fair	fair	no	one sided, codominant at 15'	retain
51556	plum	<i>Prunus sp.</i>	10	10	12	fair	fair	no	codominant at 10', significant ivy on trunk	remove
51557	bigleaf maple	<i>Acer macrophyllum</i>	15	15	14	poor	poor	no	smothered by ivy, branch dieback	remove
51580	bigleaf maple	<i>Acer macrophyllum</i>	13	13	16	fair	fair	no	one sided, multiple leaders, overtopped by adjacent trees	remove
51581	bigleaf maple	<i>Acer macrophyllum</i>	8	8	11	poor	poor	no	one sided, multiple leaders, overtopped by adjacent trees	remove
51582	bigleaf maple	<i>Acer macrophyllum</i>	7	7	9	poor	poor	no	one sided, multiple leaders, overtopped by adjacent trees	remove

Tree No.	Common Name	Scientific Name	DBH ¹	Single DBH ²	C-Rad ³	Condition ⁴	Structure	Sig. ⁵	Comments	Treatment
51002	Alaska cedar	<i>Cupressus nootkatensis</i>	6	6	6	good	fair	no	multiple leaders, size estimated	retain
51003	Alaska cedar	<i>Cupressus nootkatensis</i>	7	7	6	good	fair	no	multiple leaders, size estimated	retain
51004	Alaska cedar	<i>Cupressus nootkatensis</i>	8	8	10	good	fair	no	multiple leaders, size estimated	retain
51016	Japanese maple	<i>Acer palmatum</i>	3	3	6	fair	fair	no	sunscald	retain
51025	Oregon white oak	<i>Quercus garryana</i>	14,12,12	16	22	fair	fair	no	multiple leaders at ground level, size estimated	retain
51040	Douglas-fir	<i>Pseudotsuga menziesii</i>	22	22	18	good	fair	no	codominant at 25', size estimated	retain
51055	incense cedar	<i>Calocedrus decurrens</i>	14	14	11	good	fair	no	moderately one sided	retain
51056	Colorado blue spruce	<i>Picea pungens</i>	5	5	5	good	fair	no	moderately one sided	retain
51080	Douglas-fir	<i>Pseudotsuga menziesii</i>	36	36	27	good	fair	yes	moderately one sided	retain
51081	Douglas-fir	<i>Pseudotsuga menziesii</i>	31	31	27	good	fair	yes	one sided, codominant at 30'	retain
51082	Douglas-fir	<i>Pseudotsuga menziesii</i>	18	18	11	fair	poor	no	40% live crown ratio (lcr), poor trunk taper	retain
51083	Douglas-fir	<i>Pseudotsuga menziesii</i>	16	16	12	fair	fair	no	one sided, marginal trunk taper	retain
51084	Douglas-fir	<i>Pseudotsuga menziesii</i>	8	8	7	poor	poor	no	suppressed	retain
51085	English hawthorn	<i>Crataegus monogyna</i>	6	6	8	fair	fair	no	overtopped by adjacent trees	retain
51086	Douglas-fir	<i>Pseudotsuga menziesii</i>	26	26	20	good	fair	yes	moderately one sided	retain
51087	Douglas-fir	<i>Pseudotsuga menziesii</i>	11	11	11	fair	fair	no	overtopped by adjacent trees, one sided, codominant at top	retain
51088	Douglas-fir	<i>Pseudotsuga menziesii</i>	7	7	9	good	fair	no	moderately one sided	retain
51089	incense cedar	<i>Calocedrus decurrens</i>	8	8	5	good	fair	no	moderately one sided	retain
51090	black walnut	<i>Juglans nigra</i>	20	20	32	fair	fair	no	one sided, branch dieback, epicormic growth	remove
51133	Oregon white oak	<i>Quercus garryana</i>	25	25	20	good	fair	yes	codominant at 3' with internal crack	retain
51148	Colorado blue spruce	<i>Picea pungens</i>	8	8	10	good	fair	no	multiple leaders, offsite, size estimated	retain
51149	Austrian pine	<i>Pinus nigra</i>	10	10	10	good	fair	no	codominant at 6', offsite, site estimated	retain

Tree No.	Common Name	Scientific Name	DBH ¹	Single DBH ²	C-Rad ³	Condition ⁴	Structure	Sig. ⁵	Comments	Treatment
51388	Douglas-fir	<i>Pseudotsuga menziesii</i>	18	18	21	good	fair	no	one sided, marginal trunk taper	remove
51389	Douglas-fir	<i>Pseudotsuga menziesii</i>	8	8	8	poor	poor	no	suppressed, poor trunk taper	remove
51390	Douglas-fir	<i>Pseudotsuga menziesii</i>	21	21	19	fair	fair	yes	40% lcr	remove
51391	Douglas-fir	<i>Pseudotsuga menziesii</i>	19	19	18	good	fair	yes	one sided	remove
51392	Douglas-fir	<i>Pseudotsuga menziesii</i>	20	20	19	good	fair	yes	one sided	remove
51393	bigleaf maple	<i>Acer macrophyllum</i>	7	7	8	poor	poor	no	suppressed	remove
51394	bigleaf maple	<i>Acer macrophyllum</i>	17	17	14	good	fair	no	one sided	remove
51395	Douglas-fir	<i>Pseudotsuga menziesii</i>	14	14	12	fair	fair	no	40% lcr, marginal trunk taper	remove
51396	Douglas-fir	<i>Pseudotsuga menziesii</i>	15	15	17	fair	fair	no	one sided, lost top	remove
51397	Douglas-fir	<i>Pseudotsuga menziesii</i>	10	10	6	poor	poor	no	suppressed, P. pini along trunk	remove
51398	Douglas-fir	<i>Pseudotsuga menziesii</i>	21	21	19	good	fair	yes	moderately one sided, codominant at 25'	remove
51399	bigleaf maple	<i>Acer macrophyllum</i>	12	12	12	poor	poor	no	one sided, significant branch dieback	remove
51400	bigleaf maple	<i>Acer macrophyllum</i>	10,9	13	15	fair	fair	no	one sided, codominant at ground level	remove
51401	bigleaf maple	<i>Acer macrophyllum</i>	6	6	10	fair	fair	no	one sided	remove
51402	bigleaf maple	<i>Acer macrophyllum</i>	7	7	10	fair	fair	no	one sided	remove
51403	bigleaf maple	<i>Acer macrophyllum</i>	13	13	18	good	fair	no	one sided, multiple leaders	remove
51404	bigleaf maple	<i>Acer macrophyllum</i>	23	23	28	fair	fair	no	one sided, multiple leaders	remove
51405	bigleaf maple	<i>Acer macrophyllum</i>	6	6	5	fair	poor	no	25% lcr, poor trunk taper	remove
51406	bigleaf maple	<i>Acer macrophyllum</i>	6	6	12	poor	poor	no	overtopped by adjacent trees, suppressed	remove
51407	Douglas-fir	<i>Pseudotsuga menziesii</i>	19	19	15	fair	fair	no	40% lcr	remove
51408	Douglas-fir	<i>Pseudotsuga menziesii</i>	19	19	14	poor	poor	no	60% lcr, significant P. pini along trunk	remove
51409	bigleaf maple	<i>Acer macrophyllum</i>	10	10	12	fair	fair	no	multiple leaders, marginal trunk taper	remove
51410	bigleaf maple	<i>Acer macrophyllum</i>	15	15	19	fair	fair	no	codominant at 12' with previous leader failure	remove
51411	bigleaf maple	<i>Acer macrophyllum</i>	10	10	9	poor	poor	no	branch dieback, epicormic growth at base of trunk	remove
51412	bigleaf maple	<i>Acer macrophyllum</i>	6	6	8	poor	poor	no	one sided	remove
51413	Douglas-fir	<i>Pseudotsuga menziesii</i>	35	35	30	good	good	yes	moderately one sided	remove

Tree No.	Common Name	Scientific Name	DBH ¹	Single DBH ²	C-Rad ³	Condition ⁴	Structure	Sig. ⁵	Comments	Treatment
51583	bigleaf maple	<i>Acer macrophyllum</i>	8	8	15	poor	poor	no	one sided, multiple leaders, overtopped by adjacent trees	remove
51584	bigleaf maple	<i>Acer macrophyllum</i>	9	9	12	poor	poor	no	suppressed	remove
51585	sweet cherry	<i>Prunus avium</i>	18	18	20	good	fair	no	multiple leaders	remove
51586	bigleaf maple	<i>Acer macrophyllum</i>	16	16	16	fair	fair	no	multiple leaders, significant ivy on trunk	remove
51587	Douglas-fir	<i>Pseudotsuga menziesii</i>	24	24	21</					

Tree No.	Common Name	Scientific Name	DBH ¹	Single DBH ²	C-Rad ³	Condition ⁴	Structure	Sig. ⁵	Comments	Treatment
51635	Douglas-fir	<i>Pseudotsuga menziesii</i>	19	19	17	fair	fair	no	one sided, significant ivy on trunk, marginal trunk taper	remove
51636	bigleaf maple	<i>Acer macrophyllum</i>	8	8	12	poor	poor	no	suppressed, extensive ivy	remove
51637	bigleaf maple	<i>Acer macrophyllum</i>	10	10	15	fair	fair	no	one sided, multiple leaders, 33% lcr, marginal trunk taper	remove
51638	Douglas-fir	<i>Pseudotsuga menziesii</i>	18	18	19	good	fair	no	60% lcr, one sided, marginal trunk taper	remove
51639	bigleaf maple	<i>Acer macrophyllum</i>	7	7	14	fair	poor	no	one sided, overtopped by adjacent trees	remove
51640	bigleaf maple	<i>Acer macrophyllum</i>	7	7	13	poor	poor	no	one sided, overtopped by adjacent trees, branch dieback	remove
51641	bigleaf maple	<i>Acer macrophyllum</i>	9	9	17	good	fair	no	one sided, codominant at 20'	remove
51642	bigleaf maple	<i>Acer macrophyllum</i>	10	10	18	good	fair	no	one sided, multiple leaders	remove
51643	sweet cherry	<i>Prunus avium</i>	11	11	15	fair	fair	no	33% lcr, marginal trunk taper	remove
51644	Douglas-fir	<i>Pseudotsuga menziesii</i>	22	22	18	good	fair	yes	50% lcr, one sided	remove
51645	Douglas-fir	<i>Pseudotsuga menziesii</i>	15	15	14	fair	poor	no	50% lcr, poor trunk taper	remove
51646	Douglas-fir	<i>Pseudotsuga menziesii</i>	19	19	23	good	fair	yes	one sided, marginal trunk taper	remove
51647	Douglas-fir	<i>Pseudotsuga menziesii</i>	24	24	20	good	fair	yes	one sided, codominant at 10'	remove
51648	bigleaf maple	<i>Acer macrophyllum</i>	10	10	18	poor	poor	no	suppressed	remove
51649	bigleaf maple	<i>Acer macrophyllum</i>	10	10	19	fair	poor	no	significant lean, overtopped by adjacent trees, one sided, significant ivy	remove
51650	Douglas-fir	<i>Pseudotsuga menziesii</i>	8	8	9	good	fair	no	one sided	remove
51651	Douglas-fir	<i>Pseudotsuga menziesii</i>	14	14	12	good	fair	no	one sided, marginal trunk taper	remove
51652	Douglas-fir	<i>Pseudotsuga menziesii</i>	22	22	24	good	fair	yes	one sided	remove
51653	Douglas-fir	<i>Pseudotsuga menziesii</i>	17	17	15	fair	fair	no	60% lcr, marginal trunk taper, one sided	remove
51654	bigleaf maple	<i>Acer macrophyllum</i>	8	8	11	poor	poor	no	suppressed	remove
51655	plum	<i>Prunus sp.</i>	18	18	19	fair	fair	no	not maintained for fruit production	remove
51656	orchard apple	<i>Malus domestica</i>	9	9	15	poor	poor	no	overtopped by adjacent trees	remove
51657	orchard apple	<i>Malus domestica</i>	8,8	11	14	fair	fair	no	significant ivy, not maintained for fruit production	remove

Tree No.	Common Name	Scientific Name	DBH ¹	Single DBH ²	C-Rad ³	Condition ⁴	Structure	Sig. ⁵	Comments	Treatment
52244	Leyland cypress	<i>Cupressus x leylandii</i>	12	12	18	good	fair	no	one sided	retain
52245	weeping cherry	<i>Prunus subhirtella</i>	9	9	7	poor	poor	no	headed, decayed branches, significant decay in lower trunk	remove
52246	weeping cherry	<i>Prunus subhirtella</i>	11	11	8	poor	poor	no	headed, decayed branches, significant decay in lower trunk	remove
52247	weeping cherry	<i>Prunus subhirtella</i>	6	6	6	fair	fair	no	headed, decayed branches	remove
52248	flowering cherry	<i>Prunus serrulata</i>	24	24	17	fair	fair	no	several large pruning cuts, decay at lower trunk	remove
52249	flowering cherry	<i>Prunus serrulata</i>	26	26	21	fair	fair	no	several large pruning cuts, dead 6" diameter branch	remove
52250	flowering cherry	<i>Prunus serrulata</i>	27	27	19	fair	fair	no	several large pruning cuts	remove
52260	Douglas-fir	<i>Pseudotsuga menziesii</i>	10	10	9	good	fair	no	moderately one sided	remove
52293	western redcedar	<i>Thuja plicata</i>	15	15	12	good	good	no		remove
52294	Douglas-fir	<i>Pseudotsuga menziesii</i>	35	35	30	good	good	yes		remove
52295	Douglas-fir	<i>Pseudotsuga menziesii</i>	12	12	16	good	fair	no	heading cuts at lower branches	remove
52296	sweet cherry	<i>Prunus avium</i>	6	6	14	fair	fair	no	multiple leaders, overgrown rootstock	remove
52344	Douglas-fir	<i>Pseudotsuga menziesii</i>	14	14	10	fair	poor	no	50% lcr, poor trunk taper	remove
52345	Douglas-fir	<i>Pseudotsuga menziesii</i>	23	23	24	good	fair	yes	one sided	remove
52357	Douglas-fir	<i>Pseudotsuga menziesii</i>	34	34	25	good	fair	yes	moderately one sided	retain
52428	sweet cherry	<i>Prunus avium</i>	6	6	10	good	good	no	size estimated	remove
52521	orchard apple	<i>Malus domestica</i>	13	13	18	fair	fair	no	not maintained for fruit production	remove
52828	Douglas-fir	<i>Pseudotsuga menziesii</i>	42	42	24	good	fair	yes	trunk crosses property line at ground level, size estimated, one sided, significant ivy on trunk	retain

Tree No.	Common Name	Scientific Name	DBH ¹	Single DBH ²	C-Rad ³	Condition ⁴	Structure	Sig. ⁵	Comments	Treatment
51658	Colorado blue spruce	<i>Picea pungens</i>	8	8	7	poor	poor	no	smothered by ivy	remove
51845	deodar cedar	<i>Cedrus deodara</i>	33	33	27	good	good	yes		remove
51846	flowering cherry	<i>Prunus serrulata</i>	24	24	20	poor	poor	no	Ganoderma conk at lower trunk, overextended branches	remove
51847	orchard apple	<i>Malus domestica</i>	7	7	10	fair	fair	no	not maintained for fruit production	remove
51848	orchard cherry	<i>Prunus avium</i>	13	13	14	poor	poor	no	dieback, not maintained for fruit production	remove
51849	orchard apple	<i>Malus domestica</i>	9	9	15	fair	poor	no	not maintained for fruit production, extensive lean	remove
51850	Norway maple	<i>Acer platanoides</i>	18	18	20	poor	poor	no	sloughing bark at lower trunk	remove
51851	Norway maple	<i>Acer platanoides</i>	12	12	16	good	fair	no	multiple leaders	remove
51852	deodar cedar	<i>Cedrus deodara</i>	34	34	27	good	fair	yes	multiple leaders	remove
51853	flowering cherry	<i>Prunus serrulata</i>	17	17	16	fair	fair	no	branch dieback and decay	remove
51854	flowering cherry	<i>Prunus serrulata</i>	16	16	13	fair	fair	no	multiple heading cuts, branch dieback and decay	remove
51855	pin oak	<i>Quercus palustris</i>	20	20	23	good	fair	yes	codominant at 25'	remove
51890	English laurel	<i>Prunus laurocerasus</i>	n/a	n/a	n/a	n/a	n/a	n/a	not a tree species	n/a
51891	English laurel	<i>Prunus laurocerasus</i>	n/a	n/a	n/a	n/a	n/a	n/a	not a tree species	n/a
51892	English laurel	<i>Prunus laurocerasus</i>	n/a	n/a	n/a	n/a	n/a	n/a	not a tree species	n/a
51957	crabapple	<i>Malus sp.</i>	13	13	13	fair	fair	no	large pruning cuts, multiple leaders	remove
51958	western redcedar	<i>Thuja plicata</i>	21	21	18	good	good	yes		remove
51959	western redcedar	<i>Thuja plicata</i>	20	20	14	good	fair	yes	codominant at 2'	retain
51960	western redcedar	<i>Thuja plicata</i>	20	20	14	good	good	yes		retain
51973	Douglas-fir	<i>Pseudotsuga menziesii</i>	60	60	44	good	fair	yes	moderately one sided, size estimated, on property line	retain
52002	Douglas-fir	<i>Pseudotsuga menziesii</i>	13	13	14	good	good	no		remove
52042	Douglas-fir	<i>Pseudotsuga menziesii</i>	42	42	31	good	fair	yes	significant ivy on lower trunk, moderately one sided, moderately thin crown	remove
52064	plum	<i>Prunus sp.</i>	11	11	14	poor	poor	no	smothered by ivy, significant ivy	remove
52243	Leyland cypress	<i>Cupressus x leylandii</i>	12	12	18	good	fair	no	one sided, codominant at 4'	retain

Tree No.	Common Name	Scientific Name	DBH ¹	Single DBH ²	C-Rad ³	Condition ⁴	Structure	Sig. ⁵	Comments	Treatment
52928	Douglas-fir	<i>Pseudotsuga menziesii</i>	36	36	20	fair	fair	no	trunk does not cross property line, size estimated, one sided, significant ivy on trunk	retain

¹DBH is the trunk diameter in inches measured per International Society of Arboriculture (ISA) standards.

²Single DBH is the trunk diameter of a multi-stem tree converted to a single number according to the following formula: square root of the sum of squared DBH of each stem.

³C-Rad is the approximate crown radius in feet.

⁴Condition and Structure ratings range from very poor, poor, fair, to good.

⁵Significant tree is a tree is determined to be significant by the City Arborist based on its size, health, species, location, proximity to other significant trees, and other characteristics.

Note: Trees are defined by the City as having a minimum 6 inch DBH for Oregon White Oak, Pacific Madrone, and Pacific Dogwood, and 12 inch DBH for all other species.

23000 23010 SW BLAND CIRCLE

TREE PRESERVATION DETAILS

NO.	DATE	DESCRIPTION
0	6/2019	PLANNING 1ST SUBMITTAL

EMERIO Design

6445 SW FALLBROOK PLACE, SUITE 100
BEVINGTON, OREGON 97112
TEL: (503) 746-8812
FAX: (503) 639-9592
www.emeriodesign.com

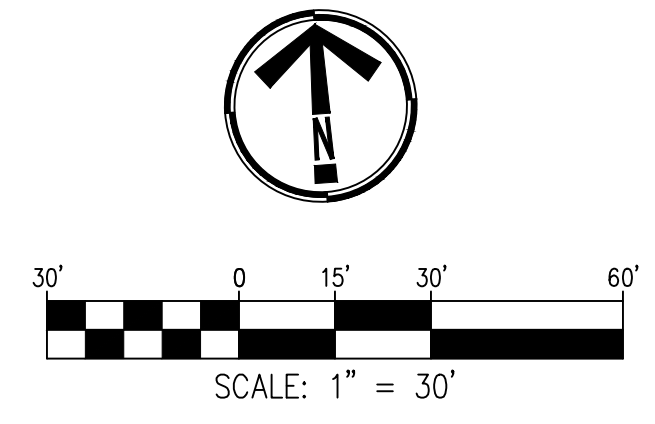

LEGEND

- 8' P.U.E.
- - - SETBACK LINES
- BOUNDARY LINE
- - - RIGHT-OF-WAY LINE
- LOT LINE

PARCEL DATA

AREA:	2.84 Ac.
ZONING:	R-7
TAX MAP:	2S1E 35B
TAX LOTS:	0400 & 0404
NO. OF LOTS:	15
PARCELS:	1

MINIMUM SETBACKS

FRONT:	20'
SIDE:	7.5'
STREET SIDE:	15'
GARAGE DOOR:	20'
REAR:	20'
MAX HEIGHT:	35'
MAX LOT COVERAGE:	35%
AVERAGE MIN LOT WIDTH:	35'

23000 23010 SW BLAND CIRCLE
 TAX MAP 21E35B
 TAX LOT 400 & 404
 WEST LINN, OREGON

PRELIMINARY PLAT

REVISIONS

NO.	DATE	DESCRIPTION
0	6/2019	PLANNING 1ST SUBMITTAL

EMERIO Design

6445 SW FALLBROOK PLACE, SUITE 100
 WEST LINN, OREGON 97146
 TEL: (503) 746-8812
 FAX: (503) 639-9592
 www.emeriodesign.com

FILE: P:\0540-001_23000_23010 SW Bland Cir\Wq\plan\0540-001_06plat_Layout_6 PRELIMINARY PLAT.dwg Plot Date: 10/4/2019 11:41 AM by: Jake Snyder

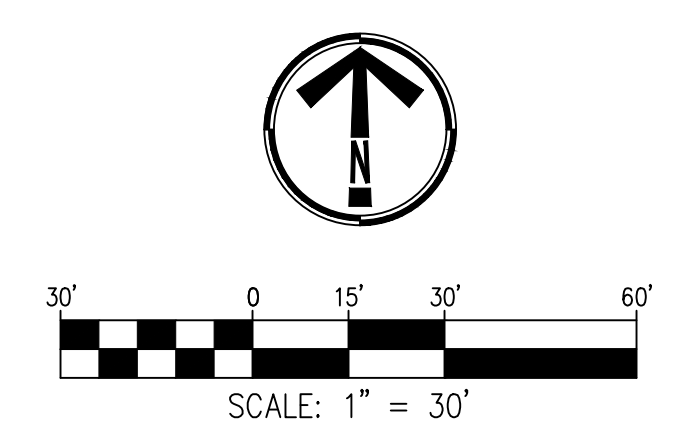

PRELIMINARY GRADING
SCALE: 1" = 30'

23000 23010 SW BLAND CIRCLE
TAX MAP 21E35B
TAX LOT 400 & 404
WEST LINN, OREGON

**PRELIMINARY GRADING
PLAN**

REVISIONS	
NO.	DATE
0	6/2019
	DESCRIPTION
	PLANNING 1ST SUBMITTAL

EMERIO
Design

6445 SW FALLBROOK PLACE, SUITE 100
BEAUMONT, OREGON 97104
TEL: (503) 746-8812
FAX: (503) 639-9592
www.emeriodesign.com

FILE: P:\0540-001_23000_23010 SW Bland Cir\wq\plan\0540-001_07\road Layout: COMPOSITE GRADING PLAN, Plot Date: 10/14/2019 11:41 AM, By: Jake Snyder

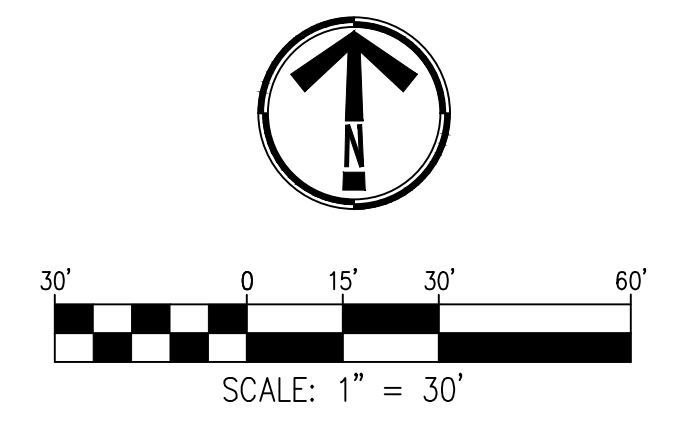

PRELIMINARY UTILITY PLAN
 SCALE: 1"=30'

23000 23010 SW BLAND CIRCLE
 TAX MAP 21E35B
 TAX LOT 400 & 404
 WEST LINN, OREGON

COMPOSITE UTILITY PLAN

REVISIONS	
NO.	DATE
0	6/2019
DESCRIPTION PLANNING 1ST SUBMITTAL	

EMERIO
Design

6445 SW FALLBROOK PLACE, SUITE 100
 WEST LINN, OREGON 97136
 TEL: (503) 746-8812
 FAX: (503) 639-9592
 www.emeriodesign.com

FILE: P:\0540-001_23000_23010 SW Bland Cir\wp\plan\0540-001_08.dwg, Layout: COMPOSITE UTILITY PLAN, Plot Date: 10/14/2019 11:42 AM, by: Jere Snyder

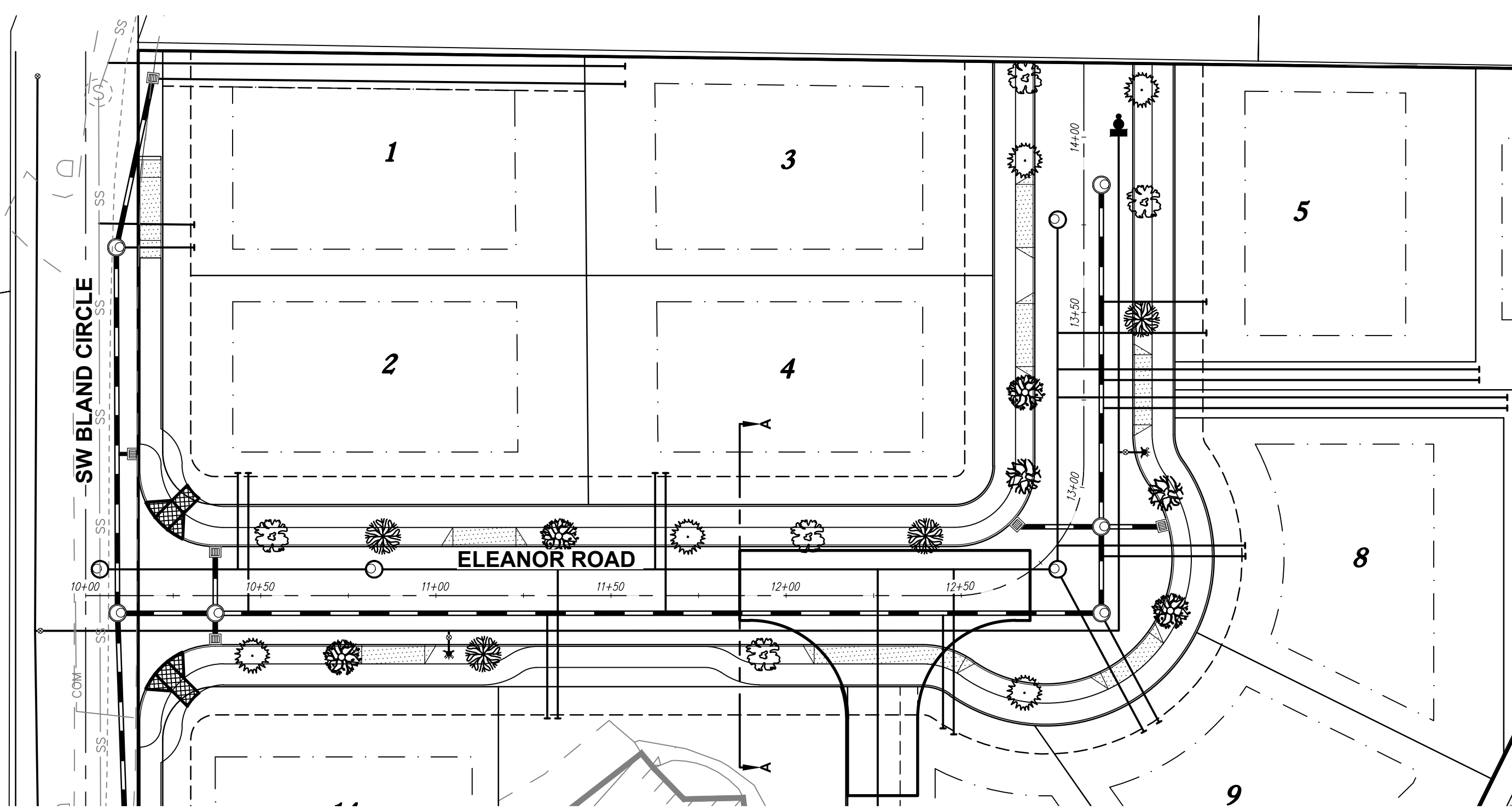

ELEANOR ROAD PLAN

SCALE: 1"=30'

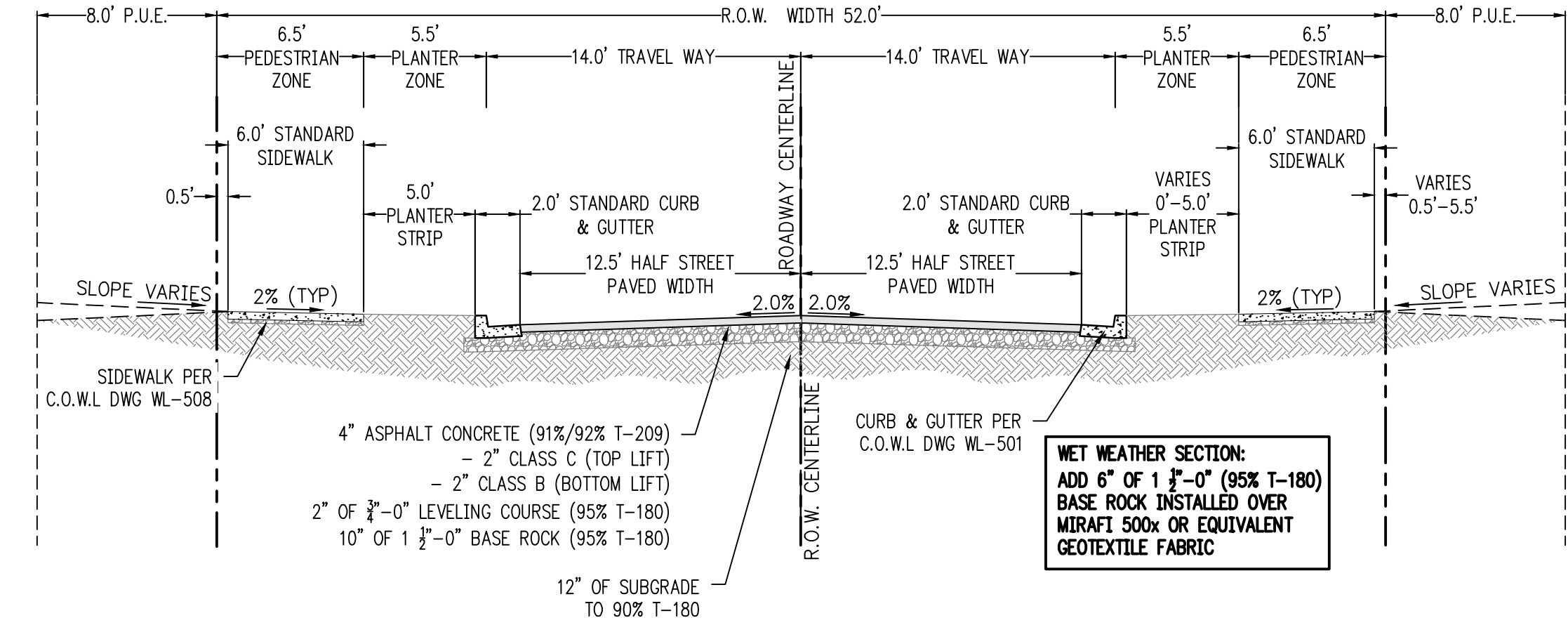

SECTION A-A: 28' LOCAL ROAD W/ DETACHED SIDEWALKS (LEFT & RIGHT) - TYPICAL SECTION

SCALE: N.T.S.

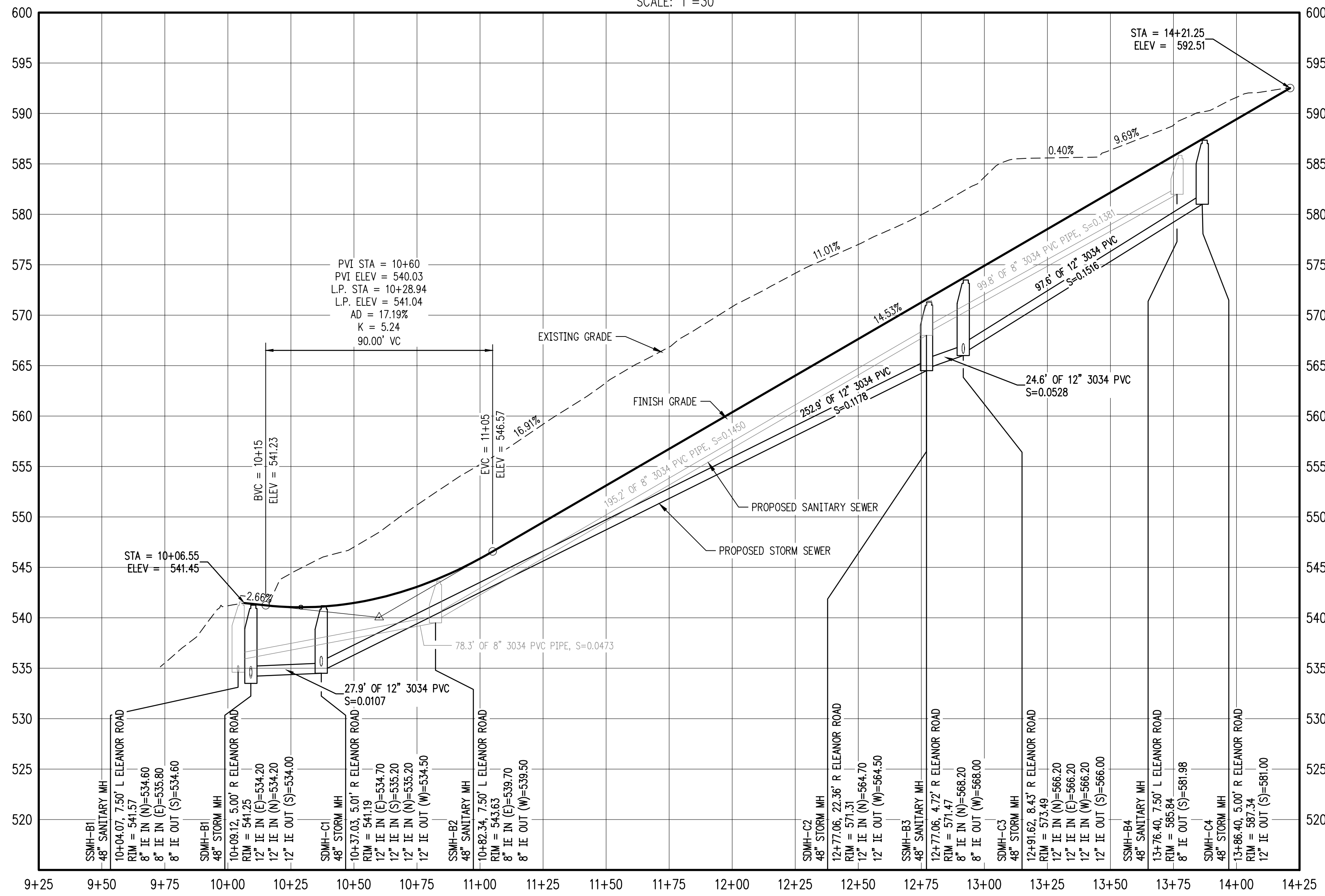

ELEANOR ROAD PROFILE

SCALE: 1"=30' HORIZ. 1"=7.5' VERT.

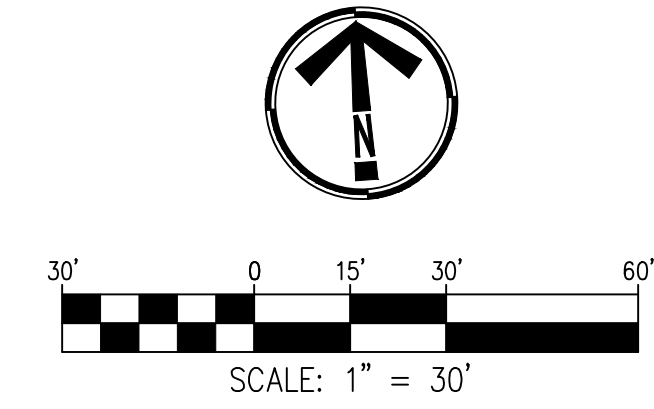

23000 23010 SW BLAND CIRCLE
TAX MAP 21E35B
TAX LOT 400 & 404
WEST LINN, OREGON

**ELEANOR ROAD PLAN,
PROFILE, & SECTION**

REVISIONS	
NO.	DESCRIPTION
0	PLANNING 1ST SUBMITTAL

EMERIO
Design

6445 SW FALLBROOK PLACE, SUITE 100
BEVINGTON, OREGON 97112
TEL: (503) 746-8812
FAX: (503) 639-9592
www.emeriodesign.com

FILE: P:\0540-001_23000 SW Bland Cr\lwp\plan\0540-001_Obseam.prof Layout: ELEANOR PLAN & PROFILE, Plot Date: 10/14/2019 11:42 AM, by: Jake Snyder

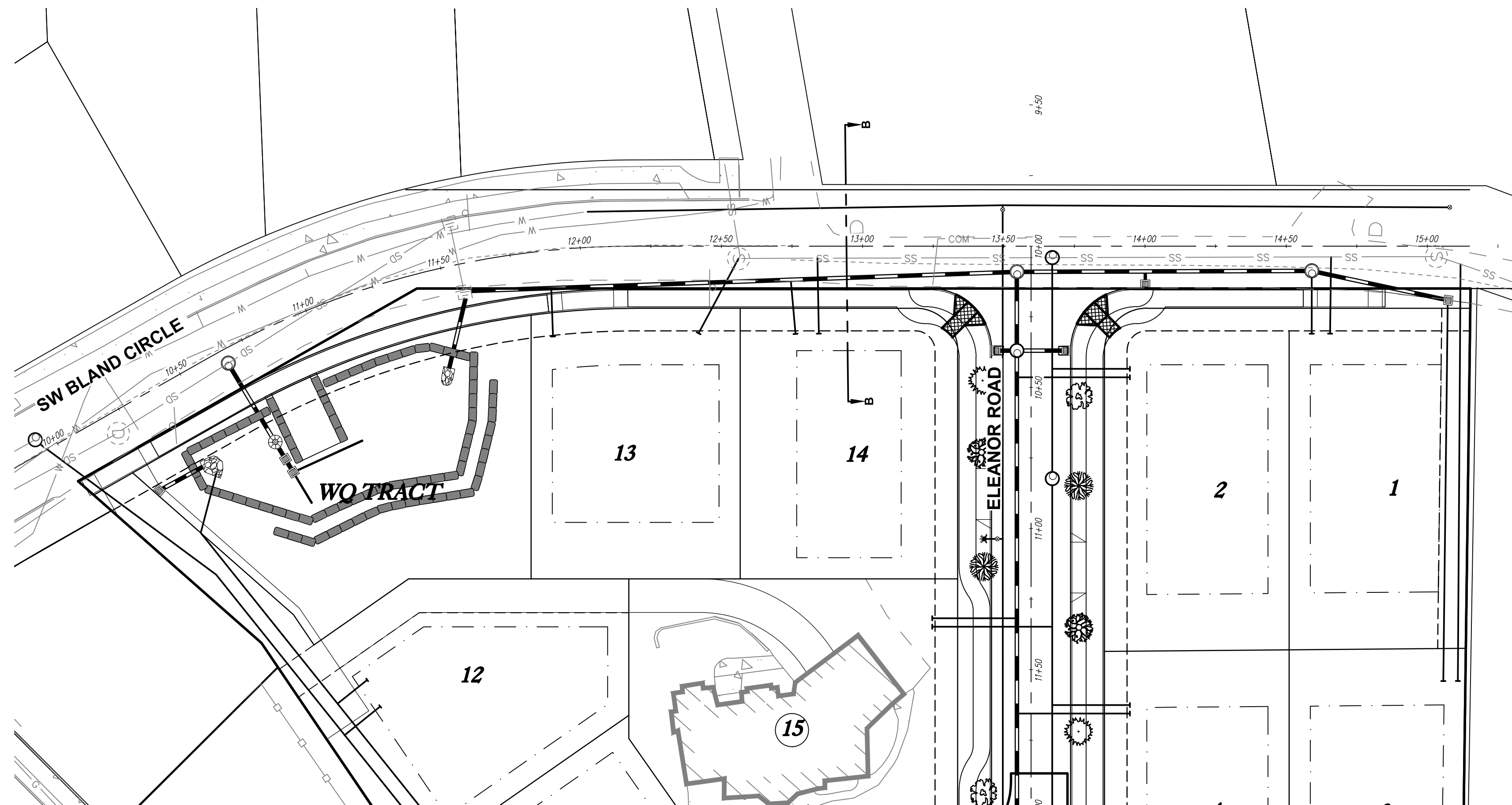

SW Bland Circle Plan
SCALE: 1"=30'

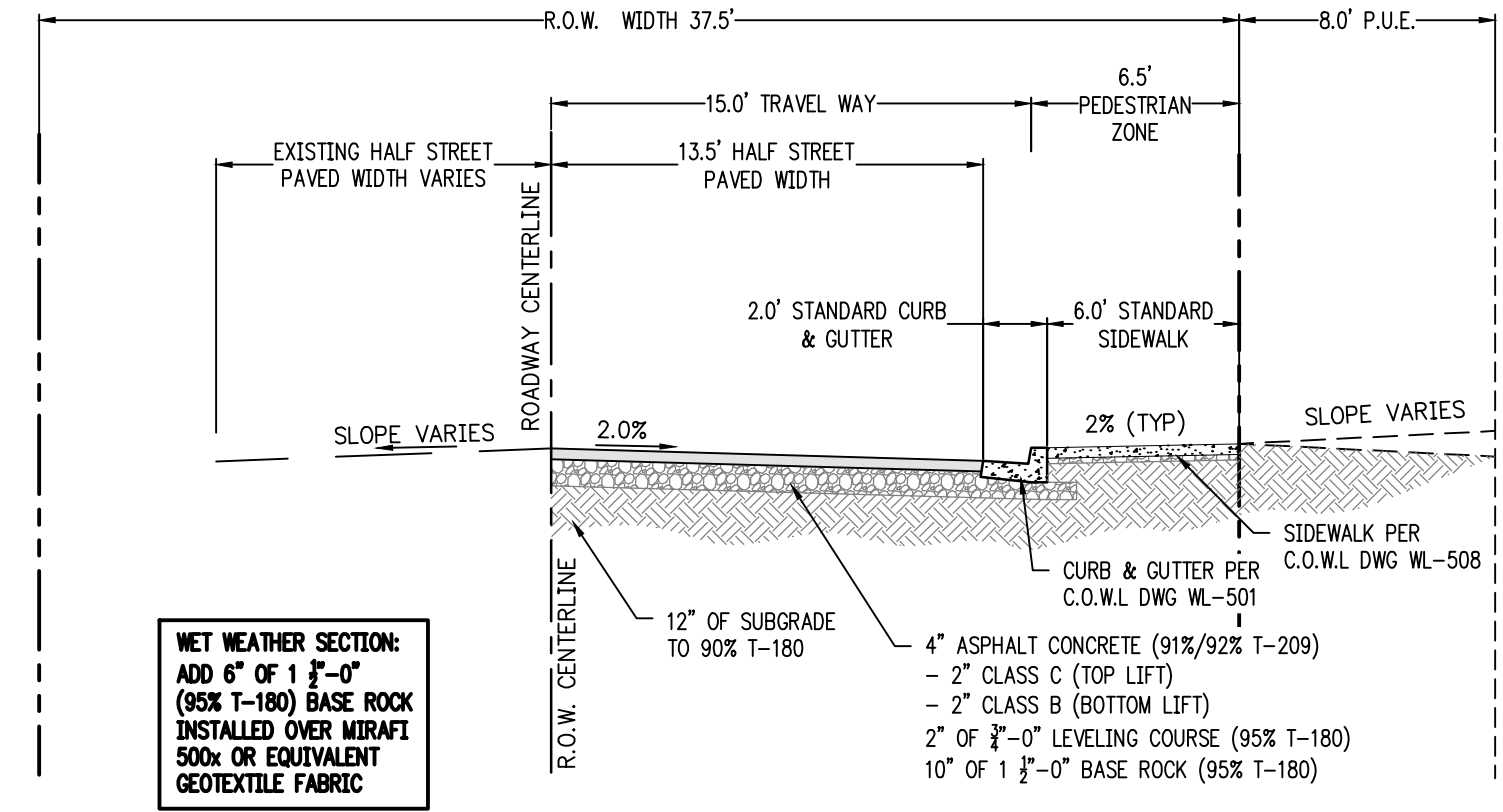

SECTION B-B: Bland Circle w/ Curb Tight Sidewalk (Right) - Typical Section
SCALE: N.T.S.

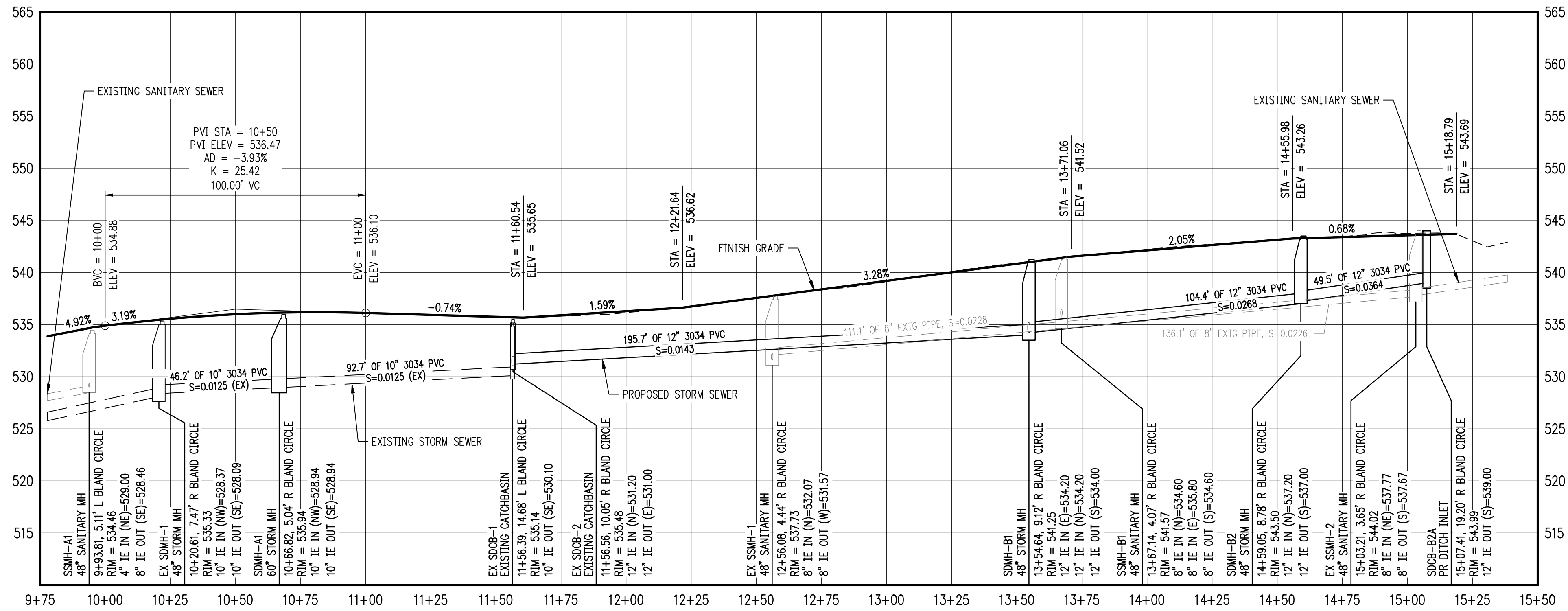
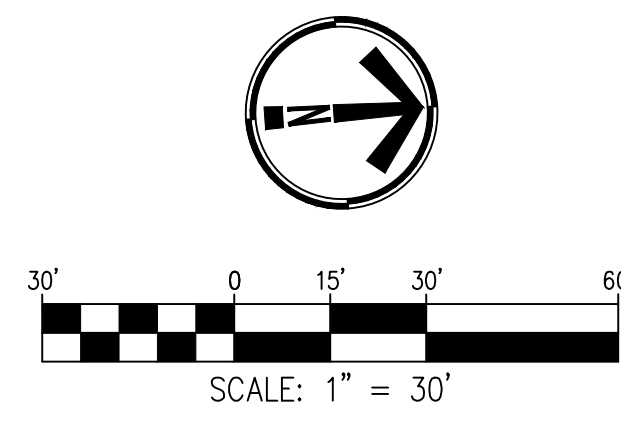

SW Bland Circle Profile
SCALE: 1"=30' HORZ., 1"=7.5' VERT.

23000 23010 SW Bland Circle
TAX MAP 21E35B
TAX LOT 400 & 404
WEST LINN, OREGON

**SW Bland Circle Plan,
Profile, & Section**

REVISIONS	
NO.	DESCRIPTION
0	PLANNING 1ST SUBMITTAL

EMERIO
Design
6445 SW FALLBROOK PLACE, SUITE 100
BEAVERTON, OREGON 97008
TEL: (503) 746-8812
FAX: (503) 639-9592
www.emeriodesign.com

SHEET
11
OF
13

FILE: P:\0540-001_23000_23010 SW Bland Cir\dwg\plan\0540-001_10band.plt, Layout: COMPOSITE UTILITY PLAN, Plot Date: 10/4/2019 11:43 AM, by: Jake Snyder

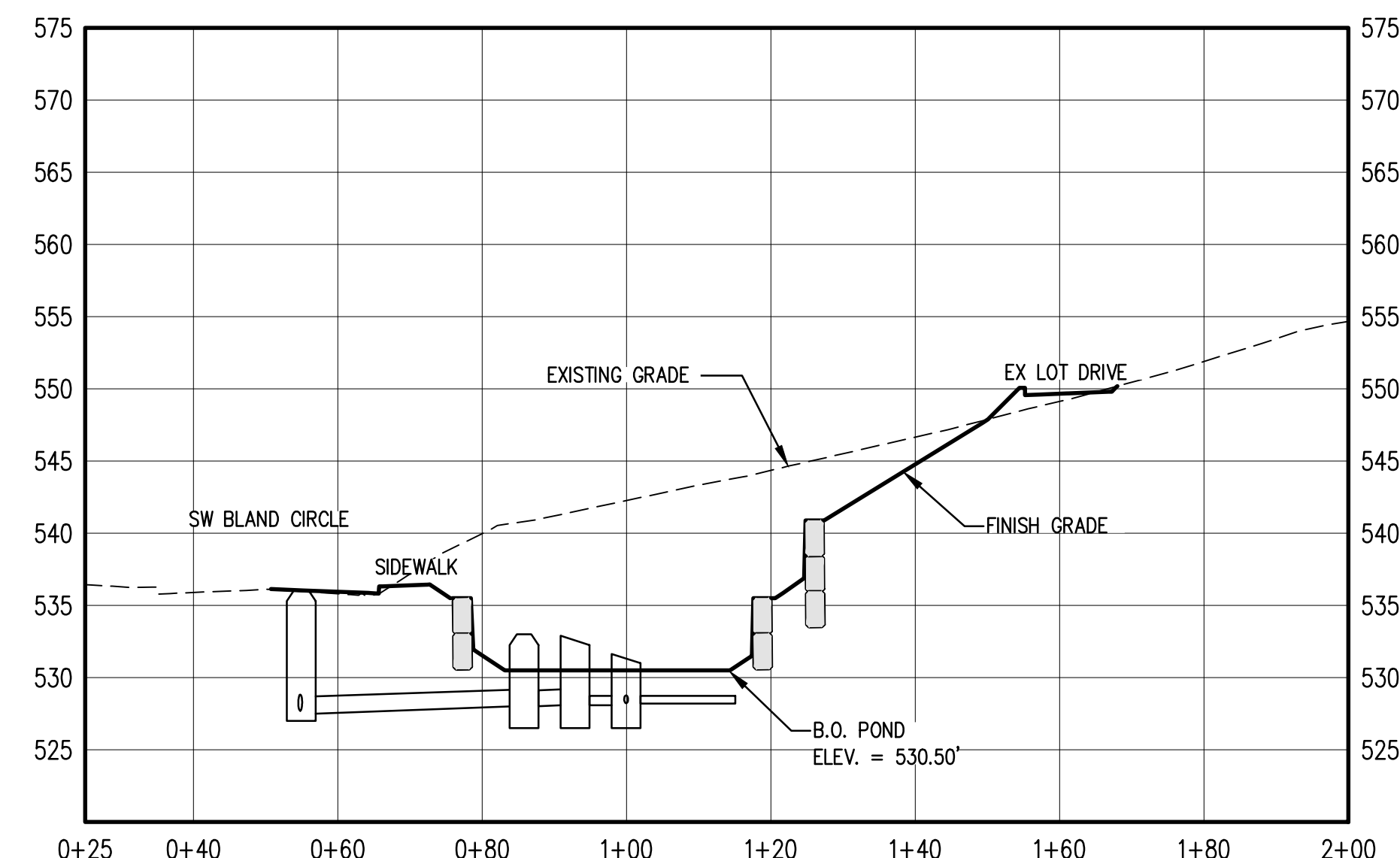
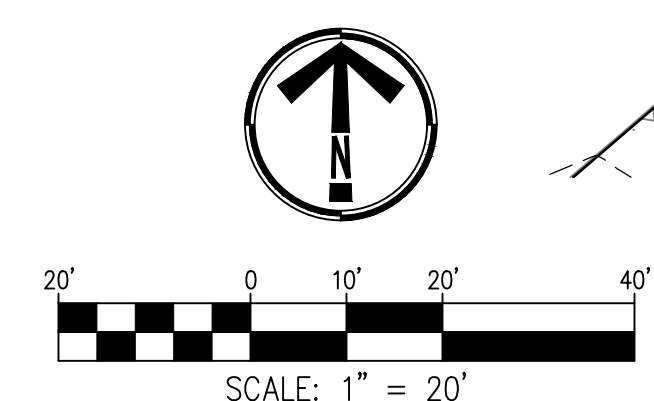
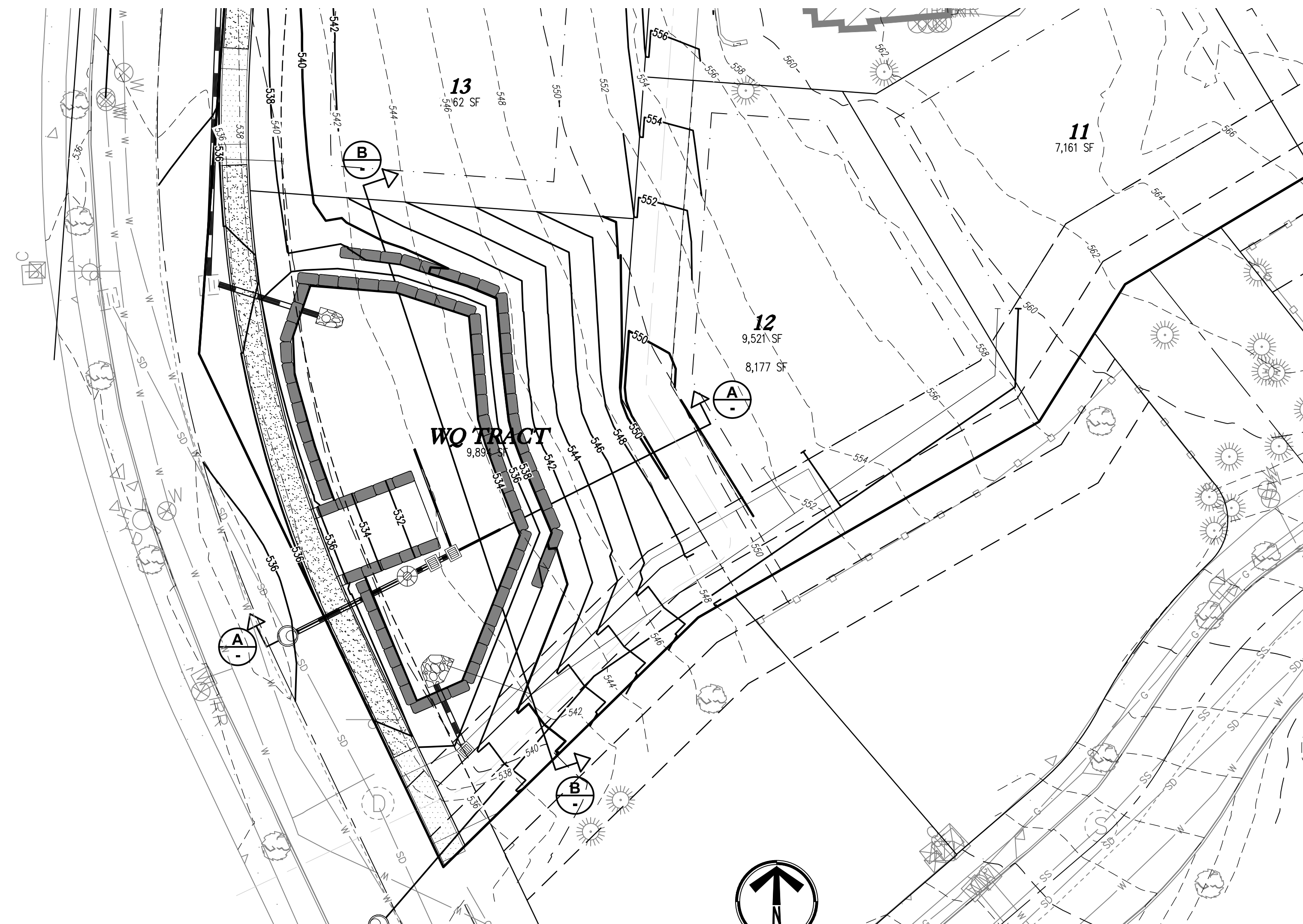

POND SECTION A-A - PROFILE
SCALE: 1"=20' HORZ. 1"=10' VERT.

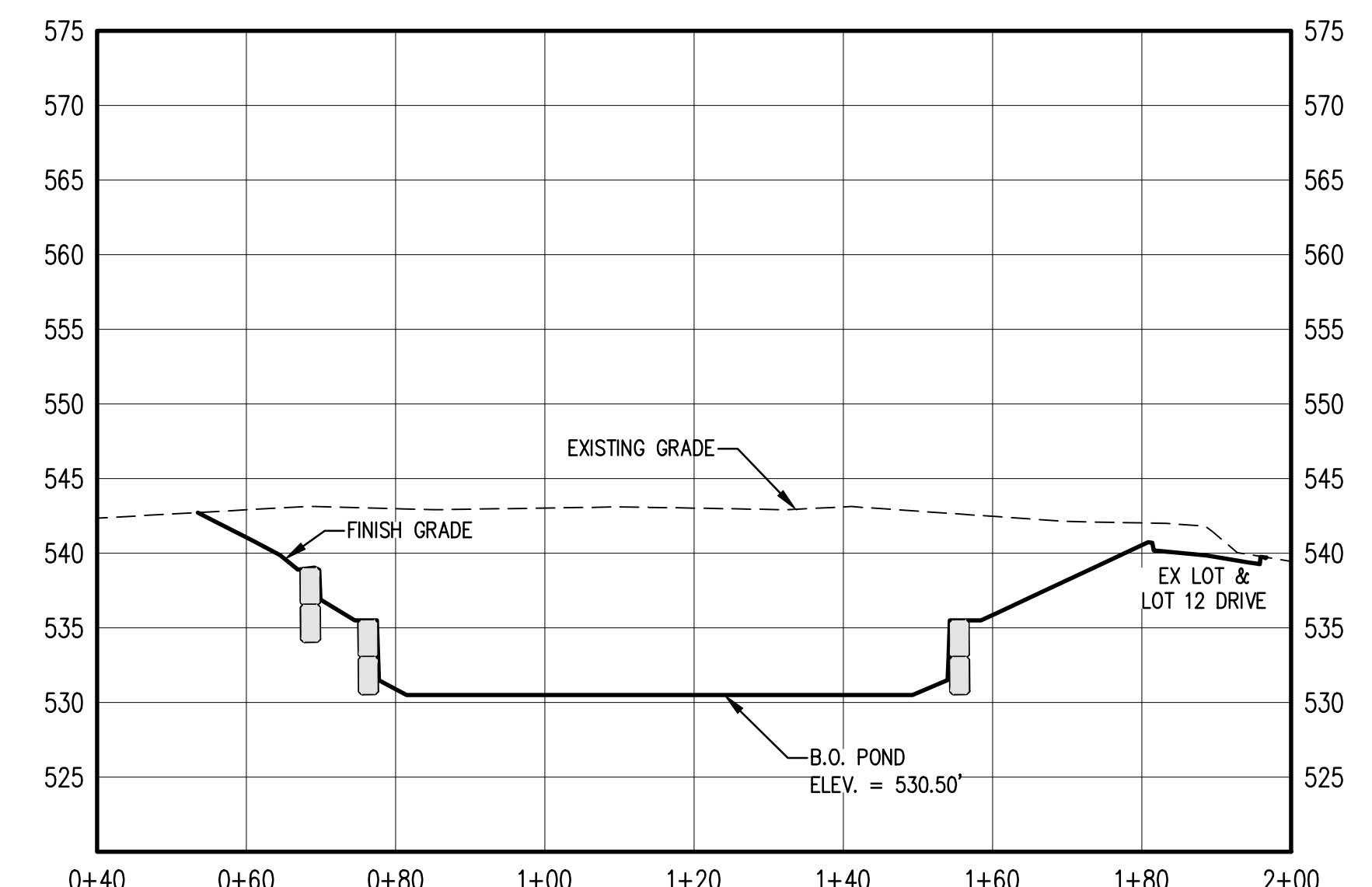

POND SECTION B-B - PROFILE
SCALE: 1"=20' HORZ. 1"=10' VERT.

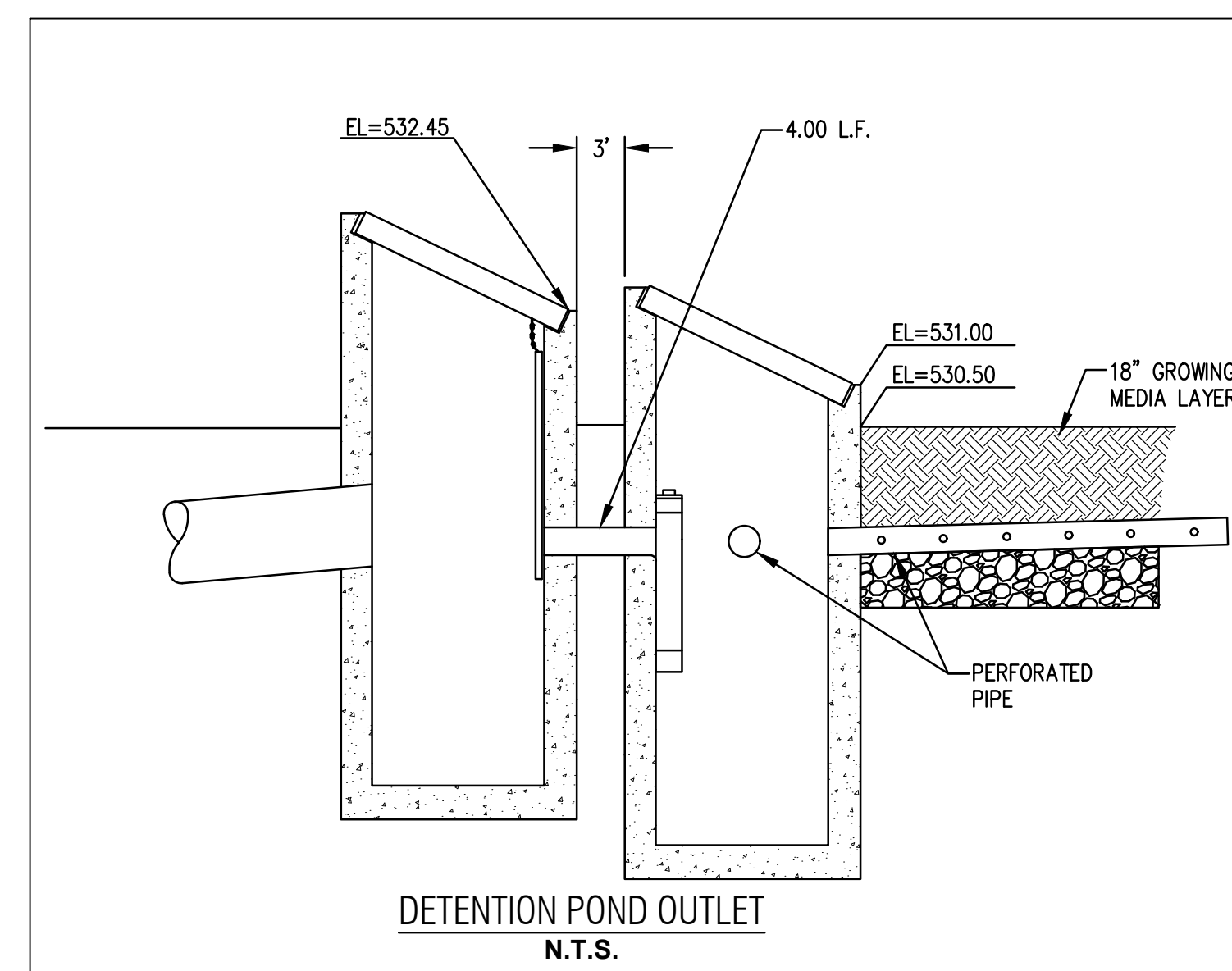
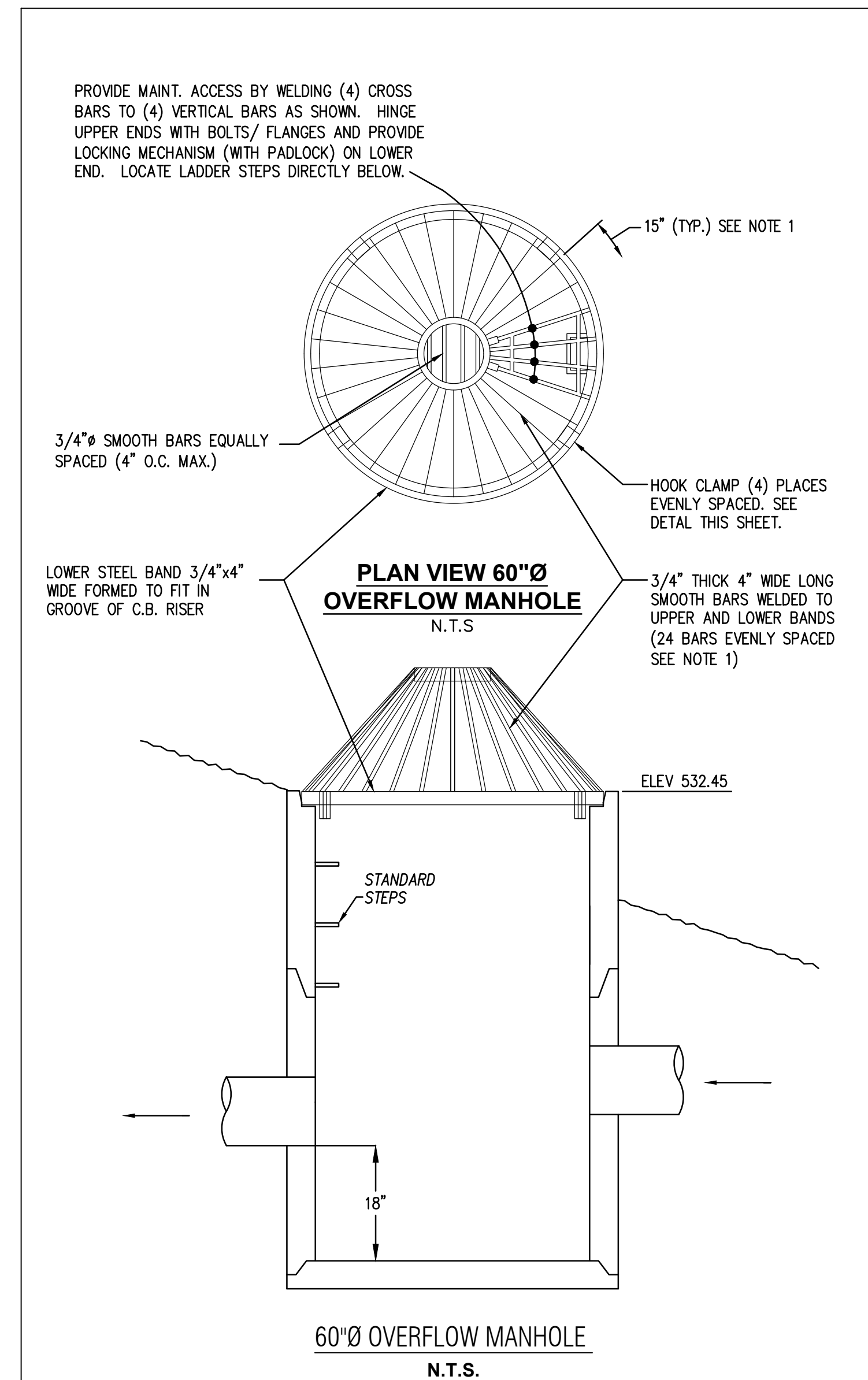

23000 23010 SW BLAND CIRCLE
TAX MAP 21E35B
TAX LOT 400 & 404
WEST LINN, OREGON

WATER QUALITY POND & DETAILS

NO.	DATE	DESCRIPTION
0	6/2019	PLANNING 1ST SUBMITTAL

EMERIO Design

6445 SW FALLBROOK PLACE, SUITE 100
BEVINGTON, OREGON 97112
TEL: (503) 746-8812
FAX: (503) 639-9592
www.emeriodesign.com

FILE:P:\0540-001_23000_23010 SW Bland Cir\Wq\plan\0540-001_P\wqps. Layout: 11 WATER QUALITY POND & DETAILS. Plot Date: 10/14/2019 11:44 AM. by: Jake Snyder

LP
X = INSTALL NEW LUMINAIRE ON POLE #.
(X = POLE #)

PUBLIC STREET LIGHTING OPTION "A" NOTES:

1. LIGHT POLE SHALL BE 30-FOOT DIRECT BURIED, 25-FOOT MOUNTING HEIGHT, TWO-PIECE GRAY, FIBERGLASS LIGHT POLE.

PGE APPROVED LIGHT POLES ARE:
SHAKESPEARE BHT3099S2BL9901
CMT MDS30-F-100-S1-HS-PC-NP-1B-22

PGE APPROVED STUBS ARE:
SHAKESPEARE BHS3099N3BL9901
CMT 25-STUB-UP

2. JUNCTION BOXES SHALL BE PGE APPROVED SPLICE BOXES.

PGE APPROVED JUNCTION BOXES ARE:
NEWBASIS FCA132418T-00043
QUAZITE A4213418A017
ARMORCAST A6001946TAX18-PGE
HIGHLINE CHA132418HE1

"ELECTRIC" OR "POWER" SHALL BE IN THE LID MARKING AREA.

3. LUMINAIRES SHALL BE PGE APPROVED 29 WATT LED, 240V, MAST-ARM MOUNTED, GRAY COBRAHEAD FIXTURE WITH TWISTLOCK P.E. RECEPTACLE.

PGE APPROVED SHOEBOX LUMINAIRES ARE:
29W LEOTEK GCJ1-20H-MV-WW-2R-450-PCR7-RWG-WL-FDC-PGE

4. THE PHOTOELECTRIC CONTROL SHALL BE PGE APPROVED EXTENDED LIFE TWISTLOCK, FAIL-ON, ELECTRONIC, 105-300 VAC, 60 HZ, PER ANSI 136.10, BRONZE HOUSING, 1.5 LUMEN TURN-ON, RATED 1000W TUNGSTEN (1800 VA BALLAST) 1.5:1 TURN-OFF/TURN-ON RATIO, SOLID BRASS PLUG BLADES, CONFORMABLY COATED CDS CELL, 160 JOULE MOV, 2-4 SEC. TURN-OFF DELAY.

PGE APPROVED PHOTOELECTRIC CONTROLS ARE:
RIPLEY RD8645
DTL DLL 1271.5 J50

5. THE WIRING FROM THE SPLICE BOX TO THE LUMINAIRE SHALL BE PGE APPROVED #10AWG, 600-VOLT, 3-CONDUCTOR, CLASS B STANDING TYPE TC WITH 45-MIL SUNLIGHT RESISTANT PVC JACKET, SUITABLE FOR DIRECT BURIED APPLICATIONS. RATED 90°C DRY AND 75°C WET.

FOR 240-VOLT APPLICATIONS, THE PGE WIRING CONFIGURATION IS:
BLACK AND RED (HOT)
GREEN (GROUND)

6. ALL MATERIALS AND WORKMANSHIP SHALL CONFORM TO P.G.E. SCHEDULE "95" OPTION "A" SPECIFICATIONS. ALL MATERIALS AND INSTALLATION SHALL BE APPROVED BY P.G.E. LIGHT POLES AND STREET LIGHTS TO BE INSTALLED BY P.G.E.

7. LIGHTING CONTRACTOR/INSTALLER IS SOLELY RESPONSIBLE FOR INSTALLATION OF CORRECT MATERIAL BASED ON CURRENT PGE APPROVED MATERIAL LIST AND JURISDICTION SPECIFICATIONS AND STANDARDS. LIGHT POLE AND FIXTURE SUBMITTAL TO PROPER JURISDICTION RECOMMENDED.

NUMERIC SUMMARY

PROJECT: BLAND CIRCLE

LABEL	CALC TYPE	UNITS	AVG	MAX	MIN	AVG/MIN
BLAND CIRCLE	ILLUMINANCE	FC	0.43	1.10	0.10	4.30
NEW STREET	ILLUMINANCE	FC	0.43	1.10	0.10	4.30

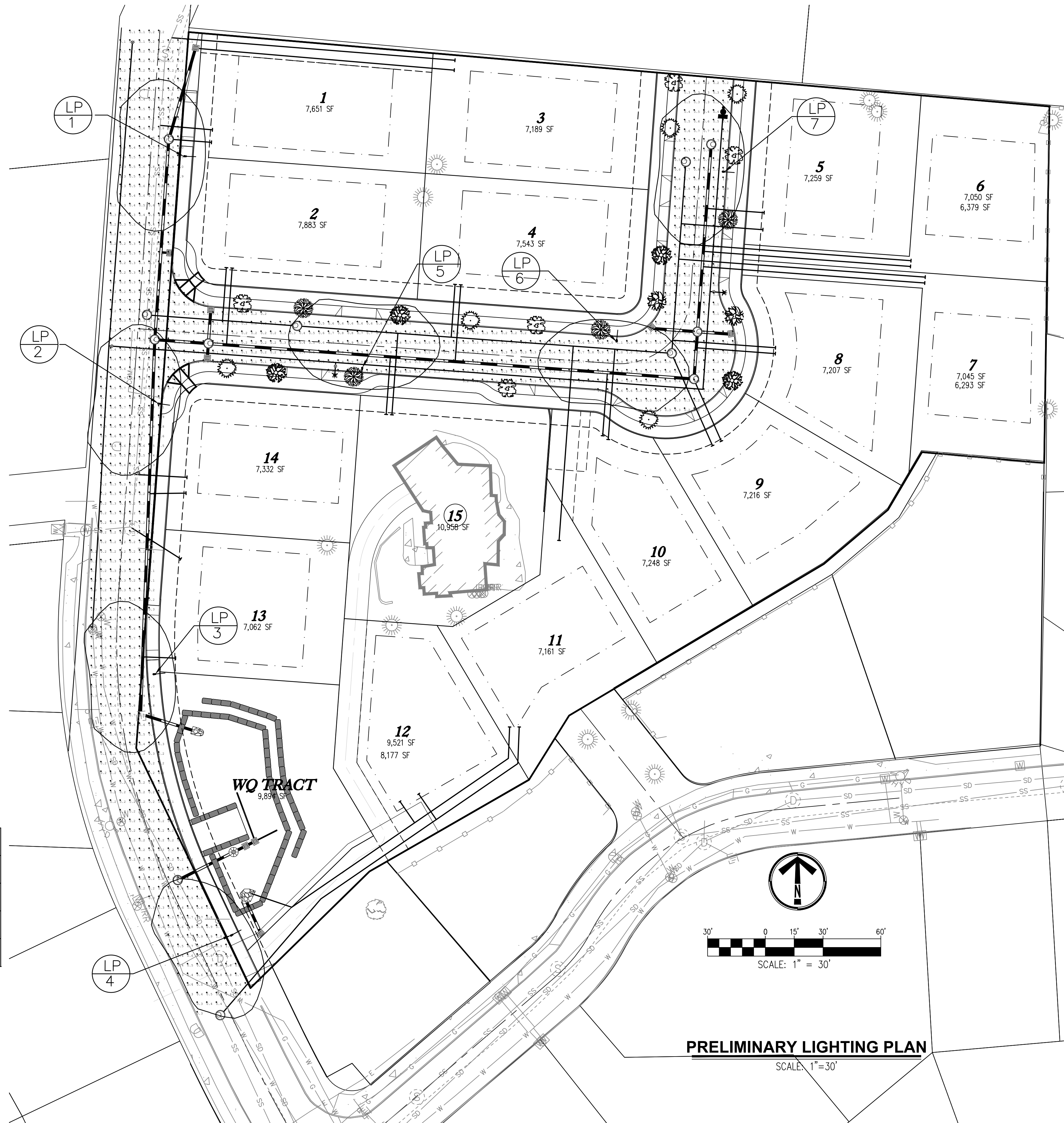
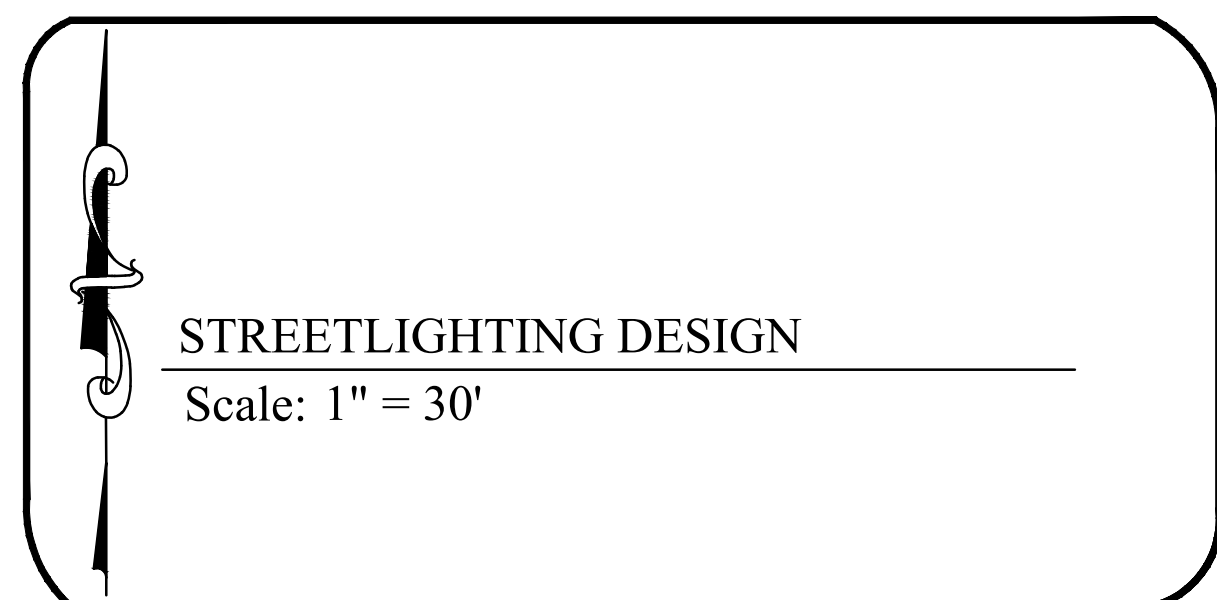

Northstar Electrical Contractors
11055 S.W. Clay Street
Sherwood, Oregon 97140
Phone 503-612-0840
Fax 503-612-0891
Email adam.suminski@NorthStarElect.com

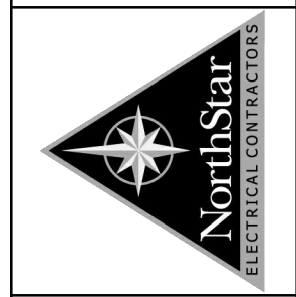

BLAND CIRCLE
WEST LINN, OR

23000 23010 SW BLAND CIRCLE
TAX MAP 21E35B
TAX LOT 400 & 404
WEST LINN, OREGON

LIGHTING PLAN

REVISIONS	
NO.	DATE
0	6/2019
	DESCRIPTION
	PLANNING 1ST SUBMITTAL

EMERIO Design
6445 SW FALLBROOK PLACE, SUITE 100
BEAUMONT, OREGON 97108
TEL: (503) 746-8812
FAX: (503) 639-9592
www.emeriodesign.com

Title: STREET LIGHTING
REV DATE NO. REV DESCRIPTION
6.7.19 1 BASE LAYOUT CHANGE
Designed by: Adam Suminski
Checked by: Jesse Culp
Date: April 15, 2019

DWG. NO. **EL1**
SHEET **13** OF **13**

FILE: P:\0540-001_23000 SW Bland Cr\Wg\plan\0540-001_Light\Layout: LIGHTING PLAN, Plot Date: 10/14/2019 11:45 AM, by: Jake Snyder

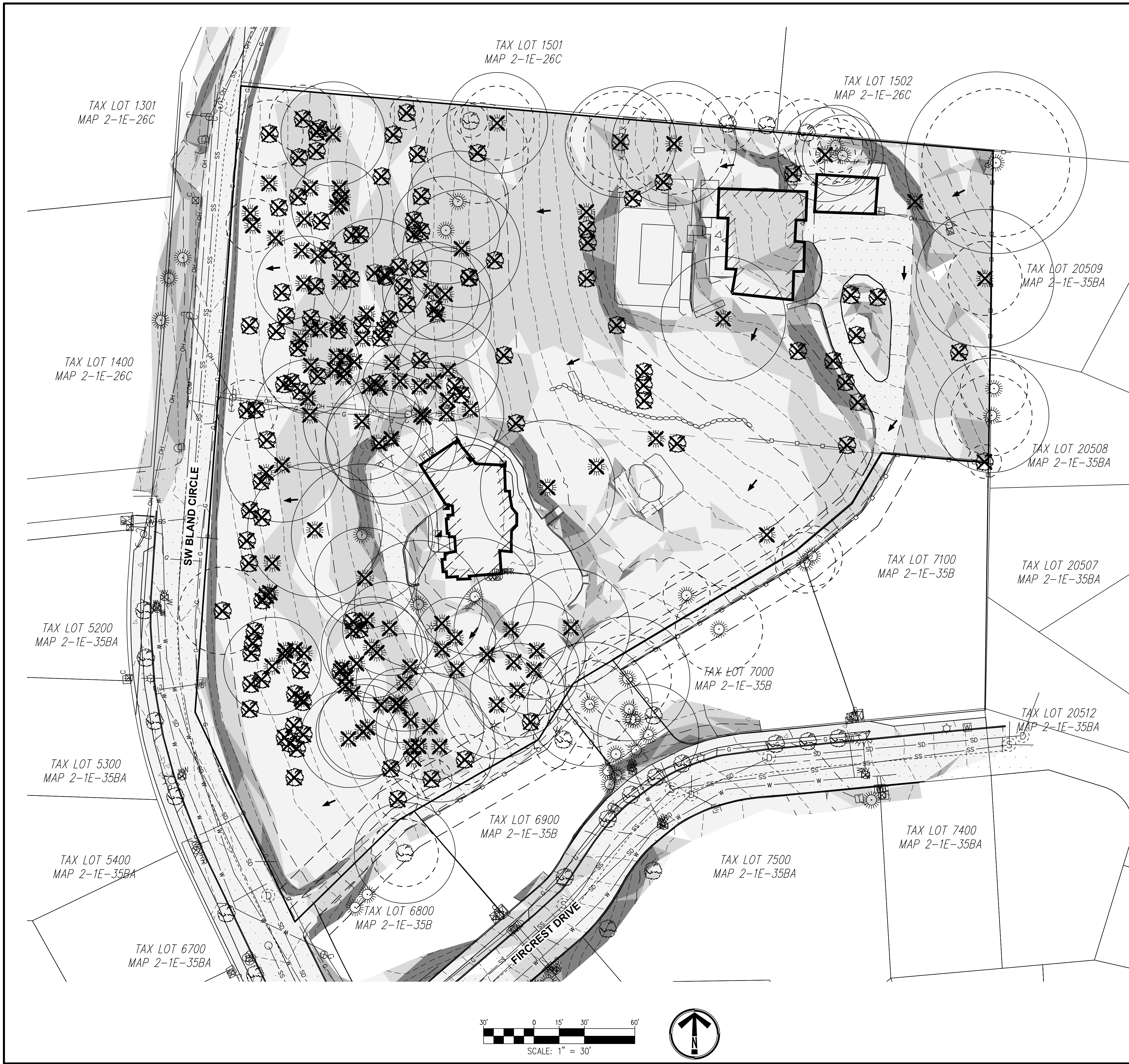

Slopes Table

Number	Minimum Slope	Maximum Slope	Area	Color
1	0%	15%	128415	
2	15%	25%	70715	
3	25%	35%	10582	
4	35%	-	11003	

23000 23010 SW BLAND CIRCLE
TAX MAP 21E35B
TAX LOT 400 & 404
WEST LINN, OREGON

SLOPE ANALYSIS PLAN

REVISIONS	
NO.	DATE
0	6/2019
DESCRIPTION PLANNING 1ST SUBMITTAL	

EMERIO
Design

6445 SW FALLBROOK PLACE, SUITE 100
BEAVERTON, OREGON 97008
TEL: (503) 746-8812
FAX: (503) 639-9592
www.emeriodesign.com

FILE: P:\0540-001_23000_23010 SW Bland Cir\lwg\plan\0540-001_13.swp, Layout: 2 EXISTING CONDITIONS PLAN, Plot Date: 10/4/2019 11:37 AM, Dr: Jake Snyder

PC-4

Public Testimony

From: [Steve Miller](#)
To: [Arnold, Jennifer](#)
Subject: FW: Fire Marshall approval- Bland Circle
Date: Wednesday, August 28, 2019 9:15:32 AM
Attachments: [image001.jpg](#)
[image002.jpg](#)
[20190819092036.pdf](#)
[20190819092024.pdf](#)
[20190819091947.pdf](#)

Hi Jennifer,

Below is TVF&R approval of our proposed turn around for Bobs Bland subdivision. Please let me know if you need anything else.

Thanks,

Steve



Steve Miller | Senior Planner/Project Manager

6445 SW Fallbrook Place, Suite 100, Beaverton, OR 97008

Ofc: 503.746.8812 Cell: 541.318.7487 | www.emeriodesign.com

From: Arn, Jason S.

Sent: Wednesday, August 28, 2019 7:20 AM

To: Pam Boyd

Cc: Steve Miller

Subject: RE: Fire Marshall approval- Bland Circle

Hi Pam,

I am sorry, I thought I had responded to this one prior to leaving town. Tualatin Valley Fire and Rescue is okay with the proposed turnaround.

Please let me know if you have any questions or need further.

Best,

Jason Arn | Deputy Fire Marshal

Tualatin Valley Fire & Rescue

Direct: 503-259-1510

www.tvfr.com

From: Pam Boyd <pam@emeriodesign.com>

Sent: Tuesday, August 27, 2019 2:50 PM

To: Arn, Jason S. <Jason.Arn@tvfr.com>

Cc: Steve Miller <stevem@emeriodesign.com>

Subject: FW: Fire Marshall approval- Bland Circle

*****The sender is from outside TVF&R – Do not click on links or attachments unless you are sure they are safe*****

Hi Jason,

We are wondering if you have had a chance to look at this site for approval that we need for the city? Please let us know if you have any questions. Thank you for your time.

Pam

From: Pam Boyd

Sent: Monday, August 19, 2019 9:26 AM

To: DeBois, Drew S. <Drew.DeBois@tvfr.com>

Subject: Fire Marshall approval- Bland Circle

Good Morning Drew,

We have a project in West Linn that we would like to get your approval on the fire turnaround. I am attaching the letter from the city, full set of planning plans and the separate sheets with highlights showing the turn around. Please let me know if you have any questions. Thank you for your help.



Pam Boyd | Coordinator

6445 SW Fallbrook Place, Suite 100, Beaverton, OR 97008

503.746.8812 | www.emeriodesign.com

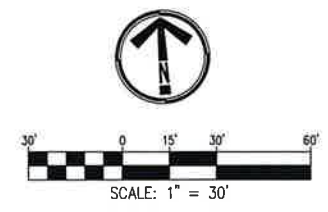

LEGEND

- 8' P.U.E.
- SETBACK LINES
- BOUNDARY LINE
- RIGHT-OF-WAY LINE
- LOT LINE

PARCEL DATA

AREA:	2.84 Ac.
ZONING:	R-7
TAX MAP:	2S1E 35B
TAX LOTS:	0400 & 0404
NO. OF LOTS:	15
PARCELS:	1

MINIMUM SETBACKS

FRONT:	20'
SIDE:	7.5'
STREET SIDE:	15'
GARAGE DOOR:	20'
REAR:	20'
MAX HEIGHT:	35'
MAX LOT COVERAGE:	35%
AVERAGE MIN LOT WIDTH:	35'

23000 23010 SW BLAND CIRCLE
 TAX MAP 21E35B
 TAX LOT 400 & 404
 WEST LINN, OREGON

PRELIMINARY PLAT

REVISIONS

NO.	DATE	DESCRIPTION
0	6/2019	PLANNING 1ST SUBMITTAL

EMERIO
Design
 6445 SW FALLBROOK PLACE, SUITE 100
 BEAVERTON, OREGON 97008
 TEL: (503) 636-9812
 FAX: (503) 636-9812
 www.emeriodesign.com

SHEET
6
 OF
12

FILE# 10540-001 23000 23010 SW Bland Cir (copy) Jan 10 5:40:00 PM, Layout: 6 PRELIMINARY PLAT, Plot Date: 7/9/2019 11:06 AM, by: Joke Snyder

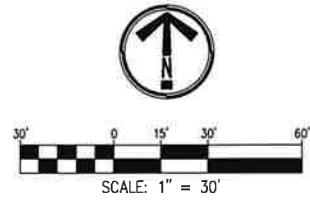

PRELIMINARY UTILITY PLAN
SCALE: 1" = 30'

23000 23010 SW BLAND CIRCLE
TAX MAP 21E35B
TAX LOT 400 & 404
WEST LINN, OREGON

COMPOSITE UTILITY PLAN

NO.	DATE	DESCRIPTION
0	6/2019	PLANNING 1ST SUBMITTAL

EMERIO
Design
6445 SW FALLBROOK PLACE, SUITE 100
BEAVERTON, OREGON 97008
TEL: (503) 638-8542
FAX: (503) 638-8542
www.emeriodesign.com

SHEET
8
12

FILE: P:\0540-001 23000 23010 SW Bland Cir\dwg\plan\0540-001_08util.dwg Layout: COMPOSITE UTILITY PLAN, Plot Date: 6/24/2019 12:03 PM, by: Jake Snyder

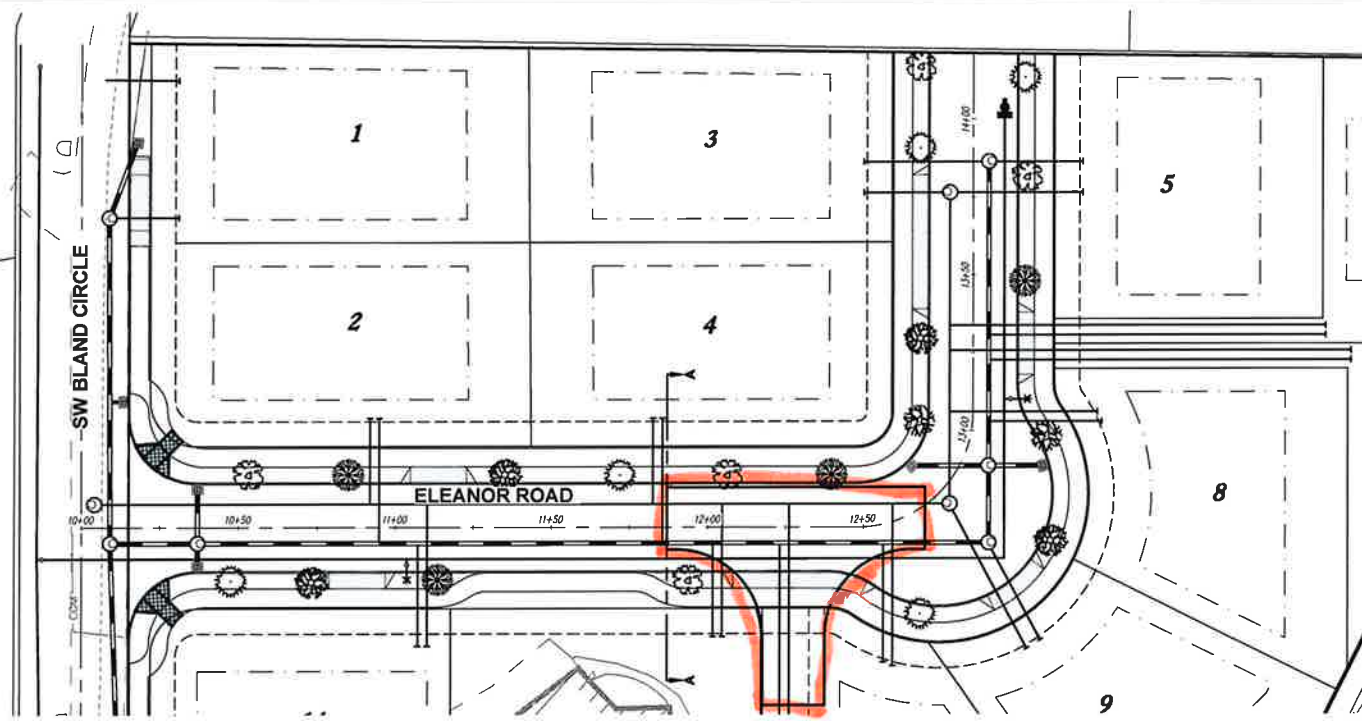

ELEANOR ROAD PLAN
SCALE: 1"=30'

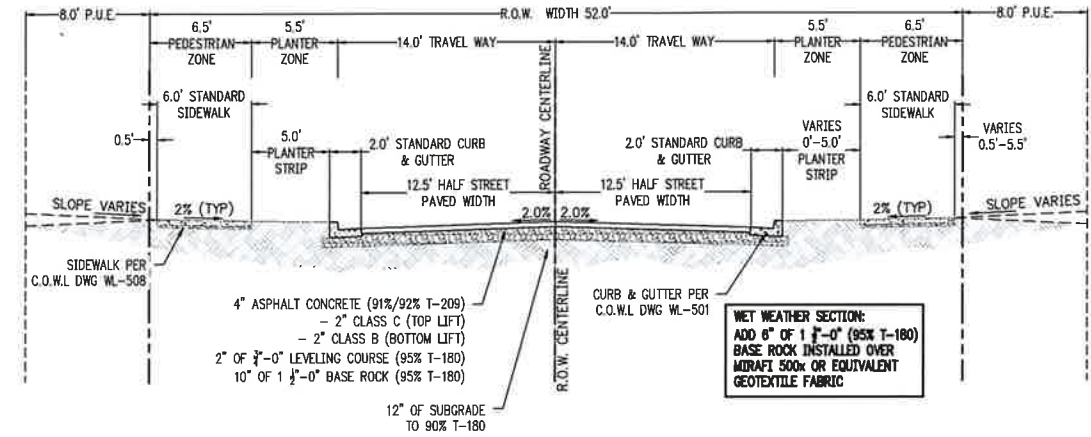

SECTION A-A: 28' LOCAL ROAD W/ DETACHED SIDEWALKS (LEFT & RIGHT) - TYPICAL SECTION

SCALE: N.T.S.

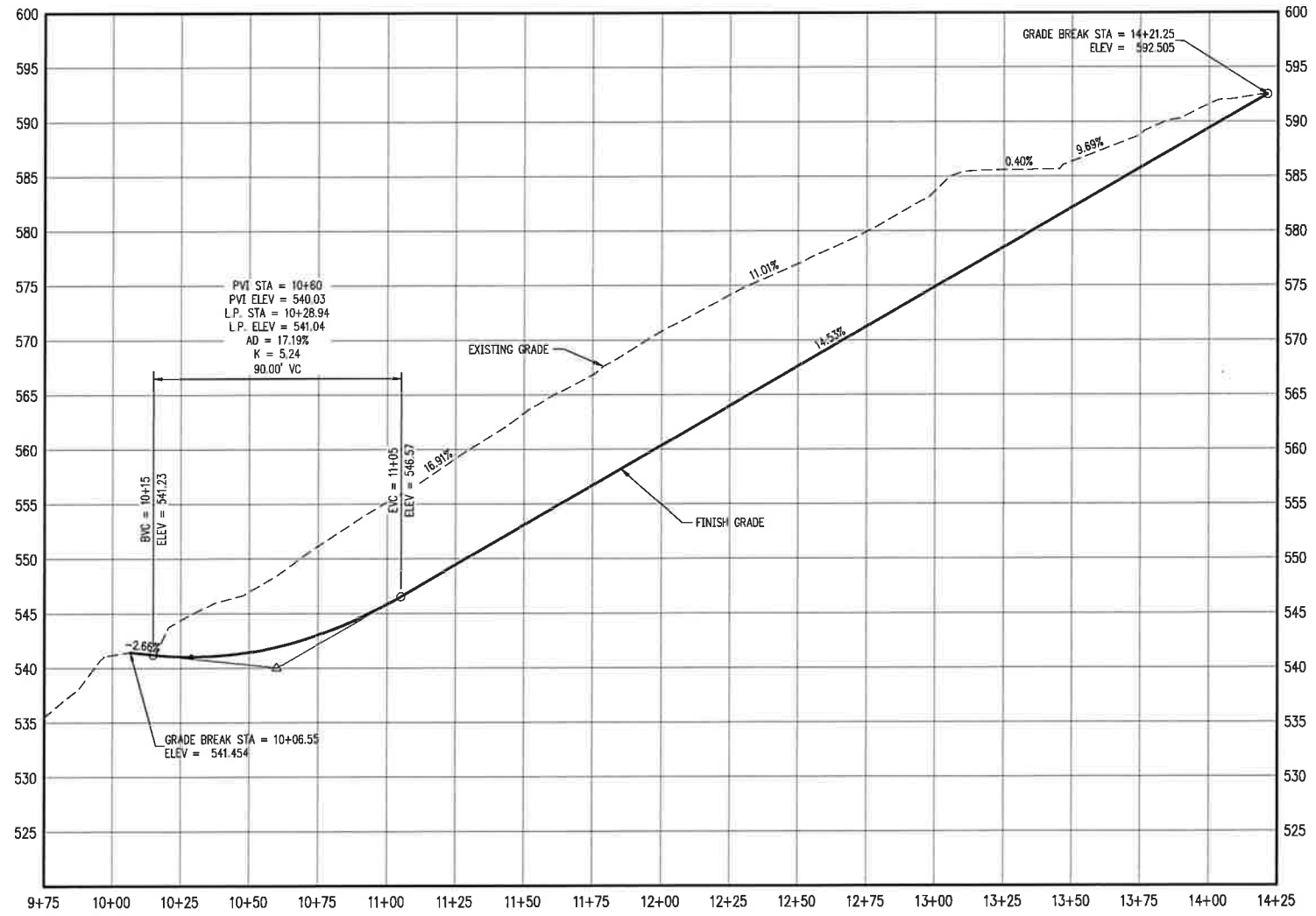

ELEANOR ROAD PROFILE
SCALE: 1"=30' HORZ. 1"=7.5' VERT.

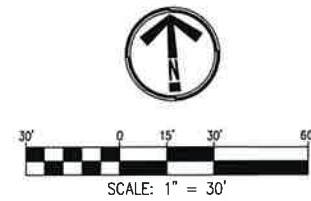

23000 23010 SW BLAND CIRCLE
TAX MAP 21E35B
TAX LOT 400 & 404
WEST LINN, OREGON

**ELEANOR ROAD PLAN,
PROFILE, & SECTION**

REVISIONS	
NO.	DESCRIPTION
0	PLANNING 1ST SUBMITTAL

EMERIO
Design
6445 SW FALLBROOK PLACE, SUITE 100
BEANBERRY, OREGON 97008
TEL: (503) 746-8832
FAX: (503) 746-8832
www.emeriodesign.com

SHEET
9
OF
12